

MAREFIX®

FIXING SYSTEMS

— by G&B GROUP —

G&B
GROUP
FIXING INNOVATION



Think Fixing

CATÁLOGO 2025

G&B FISSAGGI ESPAÑA



MAREFIX[®]

FIXING SYSTEMS

— by **G&B GROUP** —

CATÁLOGO 2025

G&B FISSAGGI ESPAÑA

Edita: MAREFIX, S.L.U.
Producción Gráfica: MAREFIX, S.L.U.
Impreso en España – Printed in Spain.



MAREFIX S.L.U. es una empresa especializada en la **Fabricación y Distribución de SISTEMAS DE FIJACIÓN**, dirigida por reconocidos profesionales con más de 40 años de experiencia en el Sector.

COMPROMISO DE EMPRESA

Todas las personas que formamos **MAREFIX**, estamos comprometidos con nuestros clientes trabajando para ofrecerles la excelencia en todos los aspectos de la empresa, mediante productos de alta calidad con homologaciones y certificaciones, servicio inmediato de 24/48 horas, amplia gama de productos en stock, precios competitivos y unas relaciones fáciles y profesionales con un único objetivo:

CONSEGUIR CLIENTES SATISFECHOS.



Ubicados en el Polígono Industrial de Lardero, a 2 km de Logroño, contamos con unas instalaciones de 3.500 m² en las que tenemos a disposición de nuestros clientes 8.000 pallets y más de 6.000 referencias para entrega inmediata.

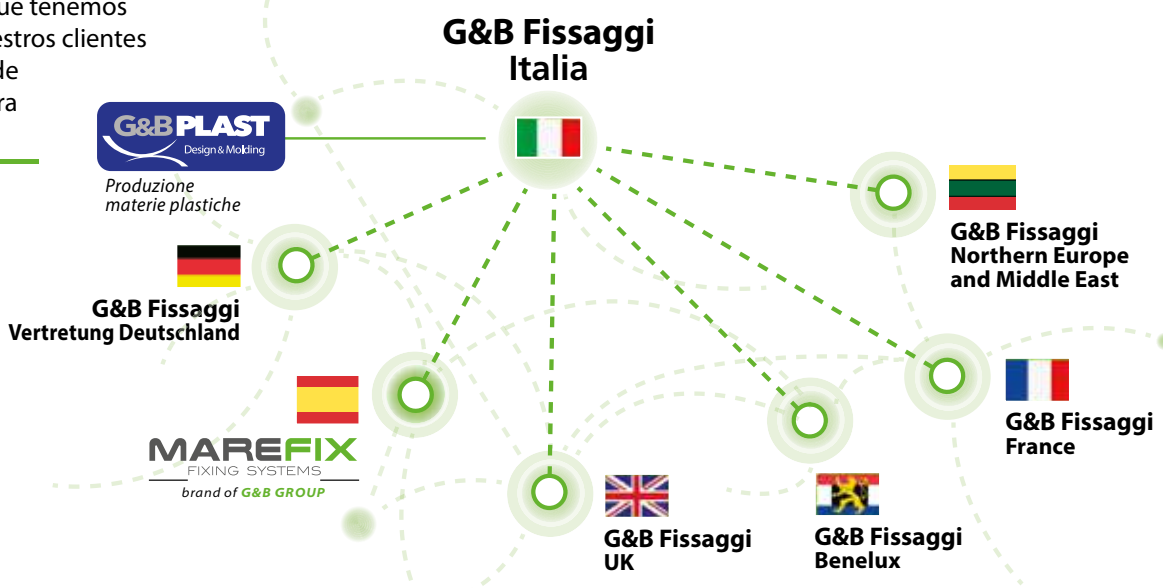

ASISTENCIA TÉCNICA Y SERVICIO AL CLIENTE

G&B
CALCULATION SUITE

Professional Fixing Design

G&B CALCULATION SUITE **An** Design
G&B CALCULATION SUITE **Et** Design
G&B CALCULATION SUITE **Ra** Design
G&B CALCULATION SUITE **Rb** Design
G&B CALCULATION SUITE **Fa** Design
G&B CALCULATION SUITE **CL** Design
G&B CALCULATION SUITE **Cm** Design

Más información en www.gebfissaggi.com

ASISTENCIA TÉCNICA

Software de cálculo online y gratuito.
Formaciones técnicas y comerciales.
Ensayos en obra.
Cálculos, equivalencias.
Asesoramiento telefónico, e-mail y presencial.
Fichas técnicas, Dop, Homologaciones.

sat@marefix.com



SERVICIO AL CLIENTE

Para información relacionada con:
pedidos nuevos, estado de pedidos
actuales, expediciones, etc.

marefix@marefix.com

Para información relacionada con:
iniciativas promocionales, nuevos productos,
contacto con agentes de zona, cursos de
formación

marefix@marefix.com



Tel. +34 941 447 825

De lunes a jueves,
8:00-13:00 / 15:00-18:00

Viernes,
07:00-15:00

CERTIFICACIONES



European Technical Assessment (ETA)

Certificación CE

Conforme a **Normativa LEED® /EQ 4.1**
(Anclajes Químicos)
EQ CREDIT: Low - Emitting Materials

Certificación **Fijaciones en ZONA SÍSMICA**
(Anclajes Químicos)

Clase de emisiones A+ para compuestos orgánicos volátiles (**COV**) en ambientes habitados

Certificación **European Quality Institute Srl**
(para soportes GB-Solar Block)

Certificación **R120 Resistencia al FUEGO**
Certificación **R90 Resistencia al FUEGO** (para GX-L Nylon)

Certificación "**Istituto Politecnico**" de Torino
para ojales para anclaje de andamios

Certificación "**Istituto Giordano S.p.A.**"
para extensiones para anclaje de andamios

10 buenas razones para elegirnos

- *Más de 40 años de experiencia*
- *Amplia gama*
- *Investigación e innovación*
- *Producción hecha en Italia*
- *Máxima versatilidad*
- *Calidad certificada*
- *Orientación al cliente*
- *Asistencia técnica*
- *Formación continua*
- *6 delegaciones en Europa*

Think Fixing



FABRICACIÓN / CALIDAD



SOMOS FABRICANTES



G&B FISSAGGI se fundó a finales de los años setenta y está **ESPECIALIZADA EN LA FABRICACIÓN** de fijaciones de nylon y productos químicos. Desde 1980, **G&B FISSAGGI** se dedica al diseño y la fabricación de productos de fijación en colaboración con el sector de la construcción mediante la distribución profesional. Nuestro objetivo es convertirnos en un verdadero socio de nuestros clientes para responder a una oferta global en fijación.

Desde mediados del año 2022, mediante la fusión con la empresa española **MAREFIX**, ponemos al servicio de nuestros clientes un amplio catálogo, con una completa gama y soluciones para los diferentes planteamientos de fijación que se puedan presentar.

MAREFIX / G&B FISSAGGI, ¿POR QUÉ?

Intentamos crear relaciones fáciles y profesionales. Aunque las exigencias del mercado y el nivel de competitividad es cada día mayor, ofrecemos a nuestros clientes unas relaciones fluidas y sencillas. Nos resulta natural ponernos en su lugar y comprender sus necesidades e inquietudes porque nosotros también somos clientes y nuestro objetivo es el mismo, hacer crecer nuestras empresas con relaciones profesionales, serias y de calidad.

COMPROMISO DE CALIDAD

Trabajamos constantemente en ampliar la oferta de productos homologados y certificados que cubran las necesidades de nuestros clientes y la demanda del mercado.

COMPROMISO CON EL MEDIO AMBIENTE

"La Tierra no es una herencia de nuestros padres, sino un préstamo de nuestros hijos."
Estamos comprometidos con el Medio Ambiente y nos preocupamos y ocupamos de él, reciclando todos nuestros residuos y cumpliendo las normativas existentes en esta materia.

COMPROMISO DE SERVICIO

Trabajamos con agencias de transporte que nos garantizan un servicio de 24 horas a capitales de provincia y ciudades importantes, y 48 horas al resto.

Estamos en un 98,7% de líneas servidas en albarán y nuestro objetivo es alcanzar el 99,8% el presente año.





PRESENTACIÓN DE PRODUCTOS

Disponemos de una amplia variedad de envases adaptados para diferentes piezas, pesos o necesidades del mercado, tanto industrial como doméstico.

También ofrecemos diferentes soluciones de exposición y venta, islas, expositores de pared, servicio de bolsas/granel, ajustándonos a las necesidades particulares de cada cliente, presentándole un proyecto económico junto con un planograma.



NEW

NOVEDADES

● FIJACIONES GRANDES CARGAS

GETO PLUS TMK

CE OPTION 1



OPTION 1



Anclaje autorroscante para instalaciones pasantes sobre soportes, incluidos los fisurados.
Nueva rosca: instalación más rápida y alto rendimiento.
Certificación CE Opción 1,
Certificado para fijaciones en zonas sísmicas. Cat. C1 y Cat. C2

GETO PLUS TMK CE 1 TEF

Cabeza hexagonal con arandela



GETO PLUS TMK CE 1 TEFI

Cabeza hexagonal con arandela
Acero INOX A4

INOX (A4)



GETO PLUS TMK CE 1 TPS

Cabeza plana avellanada, Ø 13mm



GETO PLUS TMK CE 1 TB

Cabeza alomada, Ø 14,5mm

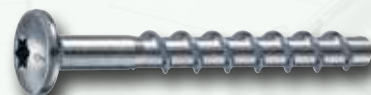

GETO PLUS TMK CE 1 TL

Cabeza alomada grande, Ø 18mm



GETO PLUS TMK CE 1 DF

Con doble rosca combinada M8/M10
Para fijación con varillas roscadas, soportes de tubos,
collarines, canales suspendidos, etc.



pág. 48-49

Tornillo hormigón GETO INFISSO GC-DE

Cabeza CILÍNDRICA, deltatone. Huella TX30.



ACABADO DELTATONE - 1.000 HORAS

pág. 51

AC-NTR

Anclaje NTR, GANCHO REFORZADO,
con arandela DIN-9021



pág. 44

STYLO FIX

Fijación de acero para placas de yeso,
taco de metal / taco de metal con tornillo
de cabeza avellanada



pág. 60

● FIJACIONES UNIVERSALES

BI-FIX

Taco BI-FIX
Con tornillo TPOZ



Bote EASY-BOX
Reutilizable



pág. 65

Taco GX-L

Taco de nylon LARGO,
cuatro expansiones,
POLIAMIDA 6.6



pág. 71

NEW

NOVEDADES

● FIJACIONES UNIVERSALES

Taco GL, Nylon

Con tornillo TPOZ

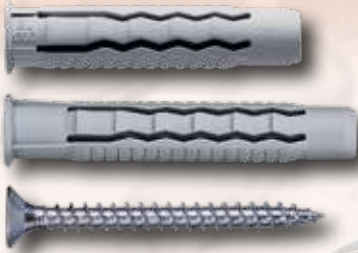

Bote EASY-BOX

Reutilizable



pág. 66

Taco TURBO JET Nylon

Color marrón oscuro, con tornillo TPS zincado negro



Color marrón oscuro, con tornillo TPS color cobre



Con tornillo M6



pág. 75

● FIJACIONES QUÍMICAS

TAMIZ PLÁSTICO, TRANSPARENTE

Para materiales huecos



pág. 88

● TORNILLOS

TRBP

Tornillo autotaladrante, CABEZA ALOMADA BAJA, arandela estampada



PINTADO BLANCO

pág. 110

● FIJACIONES PARA SANEAMIENTO

ARI-A2 / ARI-A4

Abrazadera REFORZADA ISOFÓNICA, M8 + M10
INOXIDABLE A2 / INOXIDABLE A4



INOX (A2)

INOX (A4)



ARE-A2 / ARE-A4

Abrazadera REFORZADA, M8 + M10
INOXIDABLE A2 / INOXIDABLE A4



INOX (A2)

INOX (A4)



A6

Abrazadera M6 ZINCADA



TRONCONE rosca doble



15 mm

pág. 147-151

NOVEDADES

● **FIJACIONES PARA SANEAMIENTO**

PSP-S

estante con refuerzo para cargas ligeras y medias, sección "C" galvanizado electrolítico



PSP-M

refuerzo de esquina abierto para perfiles "C" y STRUT galvanizado electrolítico



PEX

placa de conexión para perfiles STRUT galvanizado electrolítico

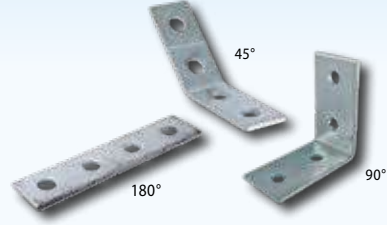

PPR-X

SOPORTE REGULABLE STRUT



PUNI

PLACA DE UNIÓN STRUT



PEX-L

placa de conexión en forma de L para perfiles STRUT galvanizado electrolítico



PEI-X

ESCUADRA PARA STRUT



PUNEX

PLACA DE UNIÓN ESCUADRA STRUT



PEX-T

placa de conexión en forma de T para perfiles STRUT galvanizado electrolítico



PERI

ESCUADRA REFORZADA STRUT



PEC

placa de conexión para perfil "C" galvanizado electrolítico

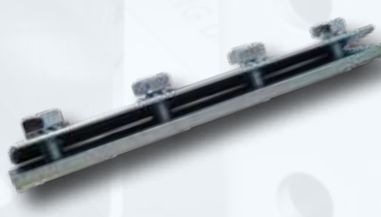

PMX-C

brida de pared galvanizado electrolítico



pág. 141-144

AB-CLS

Abrazadera/clip simple con casquillo de latón M6



AB-CLD

Abrazadera/clip doble con casquillo de latón M6



AB-CIE

Abrazadera guía simple con pre-rosca M6



AB-MULTI

Abrazadera multidímetro



pág. 152-153

LEYENDA MATERIALES



Hormigón armado



Piedra



Hormigón



Hormigón fisurado



Ladrillo macizo



Ladrillo semimacizo



Ladrillo hueco



Ladrillo adobe



Bloque hueco hormigón



Yeso laminado



Hormigón ligero

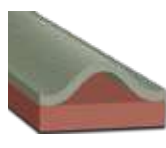

Fibrocemento

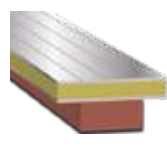

Panel sandwich



Madera sobre IPN



Madera



Viga IPN



Ensamblaje de chapas



Perfiles de chapa



Carpintería aluminio



Tubo de acero



Tubo acero inoxidable



Tubo de cobre



Tubo de PVC



Tubo flexible



Cable eléctrico



Carpintería PVC











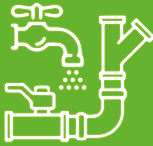

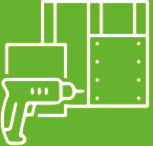
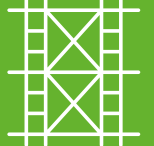





Poliestireno

SECTORES

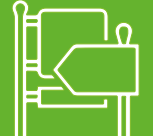
CONSTRUCCIÓN	ESTRUCTURAS	CUBIERTAS	MADERA	ALUMINIO / PVC
				
				
	<div data-bbox="320 1659 507 1727" style="background-color: #cccccc; padding: 2px;">ASCENSORES</div> <div data-bbox="320 1733 507 1917" style="background-color: #00b050; color: white; padding: 10px; text-align: center;">  </div> 			<div data-bbox="1083 1525 1270 1592" style="background-color: #cccccc; padding: 2px;">VALLADOS</div> <div data-bbox="1083 1599 1270 1783" style="background-color: #00b050; color: white; padding: 10px; text-align: center;">  </div> 

SECTORES

FONTANERÍA	ELECTRICIDAD	PANEL YESO	ANDAMIOS
			
			
			<p data-bbox="1311 936 1423 967">FACHADAS</p>  
<p data-bbox="577 1751 641 1783">SOLAR</p>  		<p data-bbox="1088 1527 1264 1550">SEÑALIZACIONES</p>  	<p data-bbox="1311 1697 1423 1729">ASIENTOS</p>  

RESUMEN DE VALORES DE EXTRACCIÓN

Valores de carga **Recomendados en kg**

DE TODOS LOS PRODUCTOS

	taco		soporte					
	Ø agujero	rosca	hormigón C20/25	ladrillo macizo	ladrillo hueco	hormigón celular	bloque hueco hormigón	cartón-yeso
FIJACIONES UNIVERSALES	BI-FIX	5		27	18	13	5	7
		6		41	21	18	7	13
		8		50	30	23	9	16
		10		73	54	30	18	16
	GL Nylon	5		32	27	14	7	
		6		50	27	14	9	
		8		54	36	27	16	
		10		84	71	54	20	
		12		109	82	59	23	
	Condor Nylon	4		11	5			
		5		29	11	11		
		6		43	27	11		
7			50	30	11			
8			64	36	14			
10			129	50	14			
Nylon Universal	6		16	16	14			
	8		32	32	18			
	10		50	50	29			
	12		76	76	42			
GBU Nylon	6		18	16	7			
	8		32	25	11			
	10		50	29	14			
Casa Nylon	9	M4	39					
	12	M5	50					
FIJACIONES LARGAS	GX-L Nylon CE	6		28 ¹	23 ¹	6 ¹		
		8		79	100	14		
		10		119	114	26		
	Condor Cornice Nylon	6		14	13			
		8		71	57			
		10		98	68			
	Later Cornice Nylon	8				43		
		10				46		
		12				64		
		16				86		
	Turbo Jet Nylon CE	5		23	18			
		6		39	46			
		8		43	50			
		10		54 ¹				
	Tornillo GETO infisso	h _{ef} 30		76				
		h _{ef} 40			29	5		
		h _{ef} 60				21		
		h _{ef} 80			179	12	12	
FIJACIONES PAREDES HUECAS	Ancora Acero DR	16	M6			11	89	
		20	M8			11	179	
	Ancora Acero DE	14	M4			11	29	
	RAPID Nylon	-					11	4
	RAPID Acero	-					11	4
	Lastro Acero	8	M4					7
		10	M5					7
		12	M6					7
14,5		M8					7	

Valores obtenidos con los tornillos de mayor diámetro entre los permitidos para cada taco.

RESUMEN DE VALORES DE EXTRACCIÓN

Valores de carga **Recomendados** en kg

DE TODOS LOS PRODUCTOS

FIJACIONES CARGAS MEDIAS	taco			soporte						
		Ø agujero	rosca	cls C20/25	ladrillo macizo	ladrillo hueco	hormigón ligero			
	BRIC BCM	12	M8	39		18	14			
	14	M10	80		21	21				
OMEGA Ottone	5	M4	36	27						
	7	M5	54	46						
	8	M6	71	64						
	10	M8	143	113						
	12	M10	179	161						
	15	M12	218	196						
Soporte: hormigón C20/25 no fisurado										
FIJACIONES GRANDES CARGAS	Ø agujero	6	8	10	12	14	16	18	20	24
	² AC-TOL		278	393	621	621	833		*787	
	SITA Acero CE 1 TTSKS			762	1190		1667		2381	
	SITA Acero CE 1 TTSK, inox e HDG		357	635	794		1667		1390	
	SITA Acero CE 1 TTSC		286	571	476		1389			
	SITA Acero CE7 GBK		357	476	635		635		1429	
	SITA Acero	179	279	369	579	712	821		1164	
	GAMMA Acero CE 1			762	762		952	1666		2143
	GETO PLUS CE1	238	476	635	992	1389				
	rosca	M6	M8	M10	M12	M16	M24	M27	M30	
	HLM ACERO CE 8	236	429	571	764	1190				
	NTR Acero	214	393	560	595					
	GBM Acero	131	179	321	357					
	ALFA Acero	143	214	286	476					
	BETA Acero CE	51	321	494	592	992				
BETA Acero	71	114	157	243	400					
FIJACIONES QUÍMICAS	barra roscada	M8	M10	M12	M16	M20	M24	M27	M30	
	MA Multi Anchor CE 7	794	1190	1389	2381	2976	4560			
	Super Hybrid SH PRO CE 7	766	942	1382	2145	3560	4524			
	XTR EXTREME HYBRID CE1	680	900	1320	1990	3390	5030			
	PRO SISMIK NORDIC VE-SK CE1	cls fisurado		741	1149	1907	2827			
		678	1122	1563	2298	3603	5027	4501	4760	
	PRO SISMIK VE-SF CE1	cls fisurado		741	1149	1907	2827			
		798	1010	1399	2043	3179	4398	3808	4328	
	EPO PLUS RE CE 1	cls fisurado		561	823	1277	2119	3142		
		1436	2020	2774	3361	5330	7318	8941	10669	
TF en vial CE 7	476	635	992	1389	2381	2976				

Profundidad de anclaje (h_{ef}) indicada en la ficha técnica del producto.

Para la elección correcta de la barra (características del acero), adecuada al tipo de carga, consulte la ficha técnica del anclaje.

¹No incluido en ETA

²Coefficiente de seguridad 3.3

*AC-TO C















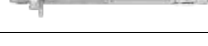

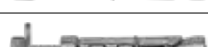
Notas

Las tablas presentan las cargas máximas recomendadas para anclajes simples, lejos de los bordes del material base y en materiales base de grosor adecuado. Los valores de carga deben entenderse como indicativos. La elección y el dimensionamiento de los anclajes son responsabilidad del proyectista y deben realizarse teniendo en cuenta los datos de las fichas técnicas y las certificaciones de los productos.

En el caso de los anclajes certificados, las cargas características y los coeficientes de seguridad son los establecidos en la Evaluación Técnica Europea (ETA) de cada anclaje. A falta de marcado CE, las cargas características se derivan de los ensayos realizados en laboratorios externos o en el laboratorio G&B en cumplimiento de las normas de referencia.

Los valores de extracción se midieron en materiales base sin yeso.



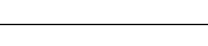

















Para los productos que pueden tener varios accesorios, el valor de extracción es el del tornillo o varilla roscada con paso métrico.

		DE USO ESPECÍFICO ●									TIPO DE CARGA				
		ADAPTABLE ●		piedra / hormigón stone / concrete	hormigón fisurado cracked concrete	hormigón celular aerated concrete	bloque hueco concrete hollow	ladrillo macizo solid brick	ladrillo hueco hollow brick	madera wood	cartón yeso plasterboard	LIGERA	MEDIA	SEMIPESADA	PESADA
SITA Acero TTS		●	38	●											●
SITA Acero TTSI INOX A2 AISI-304		●	39	●											●
SITA GBKI CE7 INOX A4 AISI-316		●	39	●											●
SITA TTSK CE1 INOX A4 AISI-316		●	40	●											●
SITA Acero GBK CE7		●	40	●											●
SITA GBK CE7 extralargo		●	41	●											●
SITA Acero TTSC CE1		●	41	●	●										●
SITA Acero TTSKS CE1		●	41	●	●										●
ALFA ALM		●	45	●				●							●
ALFA ALM / V		●	45	●				●							●
ALFA ALM / V extralargo		●	45	●				●							●
ALFA ALM / D		●	45	●				●							●
GAMMA / V CE1		●	46	●	●										●
GAMMA / VTS CE1		●	46	●	●										●
GETO PLUS SMK / TEF		●	47	●	●			●							●
GETO PLUS SMK / TPS		●	47	●	●			●							●
GETO PLUS SMK / TB		●	47	●	●			●							●
GETO PLUS SMK / DF		●	47	●	●			●							●
GETO PLUS TMK CE1 TEF		●	48	●	●			●							●
GETO PLUS TMKI CE1 TEFI INOX A4		●	48	●	●			●							●

DE USO ESPECÍFICO ●
ADAPTABLE ●

FIJACIONES GRANDES CARGAS

FIJACIONES CARGAS MEDIAS

	DE USO ESPECÍFICO ● ADAPTABLE ●										TIPO DE CARGA							
											piedra / hormigón stone / concrete	hormigón fisurado cracked concrete	hormigón celular aerated concrete	bloque hueco concrete hollow	ladrillo macizo solid brick	ladrillo hueco hollow brick	madera wood	cartón yeso plasterboard
GETO PLUS TMK CE1 TPS		NEW	49	●	●				●									●
GETO PLUS TMK CE1 TB		NEW	49	●	●				●									●
GETO PLUS TMK CE1 TL		NEW	49	●	●				●									●
GETO PLUS TMK CE1 DF		NEW	49	●	●				●									●
BETA, TT BCE			52	●														●
BETA, TT BL CE			52	●														●
BETA, TT B			52	●														●
BETA, TT BL			52	●														●
BETA, TT BI INOX A4 AISI-316			52	●														●
AC-TO			42	●	●				●									●
AC-TO INOX A2 AISI-304			42	●	●				●									●
AC-TO 8.8			42	●	●				●									●
AC-PZ			42	●	●				●									●
AC-PI INOX A2 AISI-304			43	●	●				●									●
AC-INZ			43	●	●				●									●
AC-INN			43	●	●				●									●
AC-AR			43	●	●				●									●
AC-GA			43	●	●				●									●
AC-AF			44	●	●				●									●
AC-GF			44	●	●				●									●

DE USO ESPECÍFICO ●
ADAPTABLE ●

FIJACIONES CARGAS MEDIAS

FIJACIONES LARGAS

	DE USO ESPECÍFICO ● ADAPTABLE ●	44	44	44	44	44	44	44	44	44	44	TIPO DE CARGA				
												LIGERA	MEDIA	SEMIPESADA	PESADA	
AC-AFI INOX A2 AISI-304		●	●				●						●			
AC-GFI INOX A2 AISI-304		●	●				●						●			
AC-GE		●	●				●						●			
AC-NTR	NEW	●	●				●						●			
Taco Latón OMEGA TLAT		●					●						●			
Taco Latón OMEGA TTO		●					●						●			
SITA TTS		●					●						●			
CE-AN		●					●						●			
TARAS		●					●						●			
Taco BCM		●		●	●		●	●					●			
Taco BCM / V		●		●	●		●	●					●			
Taco BCM / SA		●		●	●		●	●					●			
Taco BCM / GR		●		●	●		●	●					●			
THCH		●					●	●					●			
THCH+ARNE		●					●	●					●			
GETO INFISSO GS		●					●	●					●			
GETO INFISSO GC		●					●	●					●			
GETO INFISSO GC-DE DELTATONE 1000 H	NEW	●					●	●					●			
Taco GX-L / VT		●				●	●	●		●			●	●		
Taco GX-L / VTI INOX A4 AISI-316		●				●	●	●		●			●	●		

DE USO ESPECÍFICO ●
ADAPTABLE ●

TIPO DE CARGA

LIGERA	MEDIA	SEMIPESADA	PESADA
--------	-------	------------	--------



















FIJACIONES LARGAS

			●																	
				piedra / hormigón stone / concrete	hormigón fisurado cracked concrete	hormigón celular aerated concrete	bloque hueco concrete hollow	ladrillo macizo solid brick	ladrillo hueco hollow brick	madera wood	cartón yeso plasterboard									
Taco GX-L / VE		70	●				●	●			●	●	●							
Taco GX-L / VEI INOX A4 AISI-316		70	●				●	●	●		●	●	●							
Taco GX-L / VEFT		71	●				●	●	●		●	●	●							
Taco GX-L / VEFTI INOX A4 AISI-316		71	●				●	●	●		●	●	●							
Taco GX-L / VTF		71	●				●	●	●		●	●	●							
Taco GX-L / VA		71	●				●	●	●		●	●	●							
Taco GX-L		71	●				●	●	●				●	●						
Taco CONDOR CORNICE / V		72	●										●	●						
Taco CONDOR CORNICE / VE		72	●										●	●						
Taco LATER CORNICE / Ø8		72					●	●	●						●					
Taco LATER CORNICE / Ø10		72					●	●	●						●					
LATER CORNICE / LUVT Ø8		72					●	●	●						●					
LATER CORNICE / LUVT Ø10		73					●	●	●						●					
LATER CORNICE / LUVL Ø10		73					●	●	●						●					
LATER CORNICE / LUVL Ø12		73					●	●	●						●					
LATER CORNICE / LUVFL Ø16		73					●	●	●						●					
Taco TURBO JET / SV		74	●			●	●	●	●						●					
TURBO JET / SVI INOX A2 AISI-304		74	●			●	●	●	●						●					
Taco TURBO JET / V		74	●			●	●	●	●						●					
Taco TURBO JET / SV Ø10		75	●			●	●	●	●						●					

FIJACIONES LARGAS

TORNILLERÍA NORMALIZADA

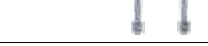



















DE USO ESPECÍFICO ●
ADAPTABLE ●

	DE USO ESPECÍFICO ● ADAPTABLE ●		75	●	●	●	●	●	●	●	●	TIPO DE CARGA			
												LIGERA	MEDIA	SEMIPESADA	PESADA
Taco TURBO JET / B	●		75	●		●									
Taco TURBO JET Nylon	●		75	●		●									
Taco TURBO JET Nylon	●		75	●		●									
Taco TURBO JET Nylon	●		75	●		●									
MRR			53												
MRH			53												
TUERCA DIN-934			134												
TUERCA DIN-985 AUTOBLOCANTE			134												
VARILLA DIN-975			134												
VARILLA DIN-975 CALIDAD 8.8			135												
ARANDELA DIN-125			135												
ARANDELA DIN-9021			135												
HA HC			136												
AR			136												
PAZ			137												
DOWEL			151												
DIN-3570 / ABA			138												
AFO			138												
GFO			138												
AFOI INOX A2	●		138												

DE USO ESPECÍFICO ●
ADAPTABLE ●

FIJACIONES PARA LA CONSTRUCCIÓN

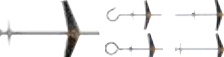
FIJACIONES PARA PAREDES HUECAS

	DE USO ESPECÍFICO ● ADAPTABLE ●	138	piedra / hormigón stone / concrete	hormigón fisurado cracked concrete	hormigón celular aerated concrete	bloque hueco concrete hollow	ladrillo macizo solid brick	ladrillo hueco hollow brick	madera wood	cartón yeso plasterboard	TIPO DE CARGA						
											LIGERA	MEDIA	SEMIPESADA	PESADA			
GFOI INOX A2 		138															
ARGOLLA OP12 / 23 		54															
ARGOLLA OP12 / 50 		54															
ARGOLLA OP50 		54	●					●									●
TACO NYLON CONDOR 		55	●					●	●							●	
AND-TACO 8 		55	●					●	●							●	
TAPÓN CP CABEZA Ø28 		55															
EXTRACTOR DINAMÓMETRO 		55															
Taco ISORAPID para SATE 		77														●	
Taco GB para GSBETON 		77			●											●	
ANCLAJE LASTRO, CS 		56				●			●							●	●
ANCLAJE LASTRO, TH 		56				●			●							●	●
ANCLAJE LASTRO, TCR 		56				●			●							●	●
ANCLAJE LASTRO, GR 		57				●			●							●	●
ANCLAJE LASTRO, AR 		57				●			●	●						●	●
ANCLAJE LASTRO, GA 		57				●			●	●						●	●
PINZA LK 		57															
Basculante ANCORA, DR 		58				●			●	●						●	●
Palomilla ANCORA, DE 		58				●			●	●						●	●
PACA 		58				●			●	●						●	●

DE USO ESPECÍFICO ●
ADAPTABLE ●

FIJACIONES PARA PAREDES HUECAS

FIJACIONES UNIVERSALES

	DE USO ESPECÍFICO ● ADAPTABLE ●		58	59	59	60	60	60	60	60	65	65	66	66	67	67	68	68	68	68	69	69	69	TIPO DE CARGA					
																								piedra / hormigón stone / concrete	hormigón fisurado cracked concrete	hormigón celular aerated concrete	bloque hueco concrete hollow	ladrillo macizo solid brick	ladrillo hueco hollow brick
PAES PAGA	●		●					●																	●	●			
BCA	●							●																	●	●			
BES BGA	●							●																	●	●			
TAPLA Nylon TN	●																								●	●			
RAPID Nylon RN RN-V	●																								●	●			
RAPID Zamak RA RA-V	●																								●	●			
STYLO FIX	●																								●	●			
Taco BI-FIX	●		●					●	●	●	●	●	●	●	●	●	●	●	●	●	●	●	●	●	●	●	●	●	●
Taco BI-FIX con tornillo TPS	●		●					●	●	●	●	●	●	●	●	●	●	●	●	●	●	●	●	●	●	●	●	●	●
GL Nylon	●		●					●	●	●	●	●	●	●	●	●	●	●	●	●	●	●	●	●	●	●	●	●	●
GL Nylon con tornillo TPS	●		●					●	●	●	●	●	●	●	●	●	●	●	●	●	●	●	●	●	●	●	●	●	●
CONDOR, Nylon	●		●					●	●	●	●	●	●	●	●	●	●	●	●	●	●	●	●	●	●	●	●	●	●
CONDOR, con reborde	●		●					●	●	●	●	●	●	●	●	●	●	●	●	●	●	●	●	●	●	●	●	●	●
TAPLAS, polipropileno	●		●					●	●	●	●	●	●	●	●	●	●	●	●	●	●	●	●	●	●	●	●	●	●
ANCORA	●																								●	●			
Taco Nylon NUDO con reborde	●																								●	●			
Nylon UNIVERSAL con reborde	●		●					●	●	●	●	●	●	●	●	●	●	●	●	●	●	●	●	●	●	●	●	●	●
Taco GBU Nylon, con collarín	●																								●	●			
Taco CASA, GR Taco CASA, GA	●		●					●	●	●	●	●	●	●	●	●	●	●	●	●	●	●	●	●	●	●	●	●	●
Taco CASA, AR Taco CASA, TO	●		●					●	●	●	●	●	●	●	●	●	●	●	●	●	●	●	●	●	●	●	●	●	●

DE USO ESPECÍFICO ●
ADAPTABLE ●

				piedra / hormigón stone / concrete	hormigón fisurado cracked concrete	hormigón celular aerated concrete	bloque hueco concrete hollow	ladrillo macizo solid brick	ladrillo hueco hollow brick	madera wood	cartón yeso plasterboard	TIPO DE CARGA			
												LIGERA	MEDIA	SEMIPESADA	PESADA
MA MULTIANCHOR		80	●	●	●	●	●	●	●				●	●	
SH-PRO SUPER HYBRID		80	●	●	●	●	●	●	●				●	●	
GEBOFIX XTR CE1 EXTREME HYBRID		81	●	●	●	●	●	●	●		●			●	
PRO-SISMIK VE-SF CE1		81	●	●	●	●	●	●	●		●			●	
PRO-SISMIK NORDIC VE-SK		82	●	●	●	●	●	●	●		●			●	
GEBOFIX EPO PLUS RE CE1		82	●	●							●			●	
CAJA MA MULTIANCHOR		83	●		●	●	●	●	●				●	●	
CAJA PRO-SISMIK VE-SF CE1		83	●	●	●	●	●	●	●		●			●	
CÁPSULA QUÍMICA GEBOFIX TF		84	●											●	

FIJACIONES QUÍMICAS

ESPÁRRAGO ROSCADO / BF		84
E. ROSCADO / BFI INOX A2 AISI-304		84
PK11 PISTOLA PRO DE NYLON		85
PK30 PISTOLA A BATERÍA		85
PK17 PISTOLA A BATERÍA		85
CP17BA BATERÍA		85
CP30BA BATERÍA		85
CP16 PISTOLA NEUMÁTICA		86
CP01 PISTOLA		86
CP05 PISTOLA		86
PISTOLA PRO / CP18 METÁLICA		86

PISTOLA PRO / CP19 METÁLICA		86
PISTOLA SK / CP07 PROFESIONAL		86
SOPLADOR PA		87
CEPILLO DE ACERO		87
MEZCLADOR		87
PICO MEZCLADOR		87
EXTENSIÓN PARA MEZCLADOR		87
TAMIZ PLÁSTICO		88
TAMIZ PLÁSTICO PASANTE		88
TAMIZ METÁLICO 1 METRO		88
TAMIZ ROSCADO DE ACERO		88

FIJACIONES QUÍMICAS

GEB KIT ASFALTO		88
GEBFOAM S750		89
GEBFOAM P750		89
GEBFOAM B1 MANUAL		89
GEBFOAM B1 PISTOLA		89

GEBFOAM TETTI PISTOLA TEJAS		90
GEBFOAM TETTI MANUAL TEJAS		90
DETERGENTE PARA GEBFOAM D500		90
PSP1 PISTOLA PRO PARA GEBFOAM		90

SPRAYS TÉCNICOS

LUBRI EXTRA HQ 10F		92
LUBRI FORTE-8F		92
DESBLOQUEANTE RÁPIDO		92
GRASO MULTIUSO		93
ACEITE DE VASELINA PURO		93
ACEITE DE CORTE PARA TROQUELES		93
ZINC BRILLANTE		94
ZINC OSCURO 98%		94

SILICONA HQ IMPERMEABILIZANTE		94
ELIMINADOR DE SILICONA		95
LIMPIADOR FRENOS Y MECÁNICA		95
AGENTE LIBERACIÓN SOLDADURA		95
LIMPIADOR CONTACTOS ELÉCTRICOS		96
GT-SLIDER DESLIZANTE CABLE		96
LIMPIADOR DE ALTA PRESIÓN		96
GEBOTEC TRACCIA TR360 TRAZADOR		97

FIJACIONES PARA SANEAMIENTO

	DE USO ESPECÍFICO ●	ADAPTABLE ●		●	●	●	●	●	●	●	●	TIPO DE CARGA				
												●	●	●	●	LIGERA
Taco ISOFIS ISA8			76	●		●	●	●	●			●				
Taco ISOFIS IS8 e IS10			76	●		●	●	●	●			●				
Taco ISOFIS AIS			76	●								●				
Taco acero ISOFIS / IA			76	●		●						●				

DE USO ESPECÍFICO ●
ADAPTABLE ●

TIPO DE CARGA

										TIPO DE CARGA					
										LIGERA	MEDIA	SEMIPESADA	PESADA		
Arandela ISOFIS con tapa		76													
SANIFIS SF2 INOX A2 AISI-304		77	●		●	●	●	●	●		●				
SANIFIS SF3 Sanitarios		77	●		●	●	●	●	●		●				
SANIFIS SF5 Lavabos		77	●		●	●	●	●	●		●				
SANIFIS SF4 Calentadores		77	●		●	●	●	●	●		●				
BR-BLANCA		100	●	●	●	●	●	●	●						
BR-NEGRA		100	●	●	●	●	●	●	●						
BRIDA CABEZA ESPECIAL		101	●	●	●	●	●	●	●						
BR-GRIS		101	●	●	●	●	●	●	●						
BR-VERDE		101	●	●	●	●	●	●	●						
BR-MARRÓN		101	●	●	●	●	●	●	●						
BR-AMARILLA		101	●	●	●	●	●	●	●						
BR-AZUL		102	●	●	●	●	●	●	●						
BR-ROJA		102	●	●	●	●	●	●	●						
BR-DETECTABLE		102	●	●	●	●	●	●	●						
BR-IDENTIFI		102	●	●	●	●	●	●	●						
BR-TACO BL / NG / GR		103	●	●	●	●	●	●	●						

FIJACIONES PARA SANEAMIENTO

DE USO ESPECÍFICO ●
ADAPTABLE ●

											TIPO DE CARGA						
											tubo de acero steel tube	tubo de cobre copper tube	tubo de PVC PVC tube	tubo flexible flexible tube	cable eléctrico electric cable	tubo de inoxidable Stainless steel pipe	LIGERA
BASE BL/NG		103	●	●	●	●	●										
PINZA BRIDAS COLOCACIÓN		103	●	●	●	●	●										
CINPER CINTA PERFORADA		104	●	●	●	●	●										
BPD/D CINTA PERFORADA		104	●	●	●	●	●										
BPD/E CINTA PERFORADA		104	●	●	●	●	●										
BT CINTA DE TEJIDO		104	●	●	●	●	●										
CLAVO GEBOPIN PERCUSIÓN		104	●	●	●	●	●										
PERCUTOR PARA CLAVO GEBOPIN		104	●	●	●	●	●										
AS		146	●	●	●	●											
AP		146	●	●	●	●											
ARI		147	●	●	●												
ARI-A2 INOX A2		147			●				●								
ARI-A4 INOX A4		147			●				●								
ARE		148	●	●	●												
ARE-A2 INOX A2		148			●				●								
ARE-A4 INOX A4		148			●				●								
AM8		149	●	●	●												
GPI		149	●	●	●	●											
GPU		149	●	●	●	●											
A6 BICROMATADA		150	●	●	●												

DE USO ESPECÍFICO ●

ADAPTABLE ●

	DE USO ESPECÍFICO ●	ADAPTABLE ●	150	●	●	●						TIPO DE CARGA					
												tubo de acero steel tube	tubo de cobre copper tube	tubo de PVC PVC tube	bloque hueco concrete hollow	cartón yeso plasterboard	LIGERA
A6 ZINCADA		NEW	150	●	●	●											
A6I			150	●	●	●											
AD6			151	●	●	●											
AD6I			151	●	●	●											
TRONCONE rosca doble		NEW	151														
ATZ			151														
ATB			151														
ATGZ			151														
SRT-RG SOPORTE RADIADOR			152														
AB-CLS AB-CLD AB-CIE		NEW	152														
FC			152														
AB-MULTI		NEW	153														
FQ FF			153														
CS CD			153														

FIJACIONES PARA SANEAMIENTO

PP-Z			140														
PP-G			140														
PSP-Z			140														
PSP-V PSP-H			140														
PSP-HX			141														
PTGZ			141														
PEZ			141														
PSP-S		NEW	141														
PP-X 21			141														
PP-X 41			141														
PSP-X			142														
PSP-RX			142														

PSP-UX		142	
PTGXZ		142	
PPR-X		142	NEW
PEI-X		142	NEW
PERI		143	NEW
PSP-M		143	NEW
PUNI		143	NEW
PUNEX		143	NEW
PEC		143	NEW
PEX		143	NEW
PEX-L		144	NEW
PEX-T		144	NEW
PMX-C		144	NEW
PTP		144	

	DE USO ESPECÍFICO ●	ADAPTABLE ●		ensamblaje de chapas metal panels	perfiles de chapa metal elements	carpintería aluminio aluminium windows	viga IPN beam IPN	panel sandwich sandwich panels	TIPO DE CARGA				
									LIGERA	MEDIA	SEMIPESADA	PESADA	
DIN-7504-K TBE			106	●	●								
DIN-7504-K TBE+ARNE			107	●	●								
AR-NE AR-NE INOX A2			108										
EPDM GRIS EPDM GRIS A2			108										
CUELLO INOX A2 PARAGUAS INOX A2			108										
TAPHEX			108										
DIN-7504-K TBE-INOX A2			109			●							
DIN-7504-K TRE			109	●	●								
DIN-7504-K TRE+ARNE			109	●	●								

DE USO ESPECÍFICO ●
ADAPTABLE ●

TORNILLOS

	DE USO ESPECÍFICO ● ADAPTABLE ●		110	ensamblaje de chapas metal panels	perfiles de chapa metal elements	carpintería aluminio aluminium windows	viga IPN beam IPN	panel sandwich sandwich panels	fibrocemento fibrecement	madera sobre IPN wood on steel IPN	TIPO DE CARGA						
											LIGERA	MEDIA	SEMIPESADA	PESADA			
TVI / VIGA		●	110	●	●		●										
TVI+ARNE		●	110	●	●		●										
TRB		●	110	●	●	●											
TBI BIMETAL		●	111	●	●												
TBI+ARNE BIMETAL		●	111	●	●												
TRBI BIMETAL		●	111	●	●												
TRBI+ARNE BIMETAL		●	111	●	●												
TVIB-VIGA BIMETAL		●	111	●	●		●										
TVIB+ARNE BIMETAL		●	111	●	●		●										
TS3		●	112	●	●			●									
TS3+ARNE		●	112	●	●			●									
TS5		●	112	●	●		●	●									
TS5+ARNE		●	112	●	●		●	●									
TFI		●	113	●	●		●		●								
TABA, PHILLIPS TABA, TORX		●	113							●							
TBCEZ		●	114	●	●	●											
TBCEN TBCEB		●	114	●	●	●											
TBCEL		●	114	●	●	●											
TBCEI-INOX A2		●	114	●	●	●											
TACEZ		●	114	●	●	●											







DE USO ESPECÍFICO ●
ADAPTABLE ●

TORNILLOS

				ensamblaje de chapas metal panels	perfiles de chapa metal elements	carpintería aluminio aluminium windows	PVC PVC windows	madera wood	TIPO DE CARGA				
									LIGERA	MEDIA	SEMIPESADA	PESADA	
TACEN TACEB		114	●	●	●								
TACEI-INOX A2		114	●	●	●								
DIN-7504-N TBR		115	●	●	●								
DIN-7504-N TBRN		115	●	●	●								
DIN-7504-N TBT, TX-OXBIT		116	●	●	●								
DIN-7504-N TBTN, TX-OXBIT		116	●	●	●								
TCR		116											
DIN-7504-N TBR-INOX A2		117	●	●	●								
DIN-7504-N TBR-PINT		117	●	●	●								
DIN-7504-P TBP		118	●	●	●								
DIN-7504-P TBPN		118	●	●	●								
TPVC-10		119					●						
TPVC-20		119					●						
TPVC-20B		119					●						
TPVC-40		119					●						
TPVC-50		119					●						
DIN-7981 TR81		120	●	●	●								
DIN-7981 TR81N		120	●	●	●								
DIN-7981 TR81P		121	●	●	●								
DIN-7982 TR82		121	●	●	●								

DE USO ESPECÍFICO ●
ADAPTABLE ●

TORNILLOS

											TIPO DE CARGA				
											LIGERA	MEDIA	SEMIPESADA	PESADA	
TAU			122	●	●										
TAU+ARNE			122	●	●										
TINVZ			123						●						
TINVN			123						●						
TINVI INOX A2 AISI-304			123						●						
ESTINV			123						●						
DIN-571 TBA			124						●						
DIN-571 TBA-RT			124						●						
DIN-571 / TBA INOX A2 AISI-304			124						●						
TTXEB			125						●						
TTXEZ			126						●						
TTXE-A2 INOX A2 AISI-304			126						●						
TTX-AR			126						●						
TTX-CAB			127						●						
TT-BR			127						●						
DIN-7505-B TPOR			127						●						
DIN-7505-A TTOB			128						●						
DIN-7505-A TPOB			128						●						
DIN-7505-A TPOZ			129						●						
DIN-7505-A / TPOI INOX A2 AISI-304			129						●						

TORNILLOS

DE USO ESPECÍFICO ●
ADAPTABLE ●

	Imagen	Código	ensamblaje de chapas metal panels	perfiles de chapa metal elements	carpintería aluminio aluminium windows	PVC PVC windows	madera wood	cartón yeso plasterboard	viga IPN beam IPN	TIPO DE CARGA				
										LIGERA	MEDIA	SEMIPESADA	PESADA	
TPL FOSFATADO		130						●						
TPL ZINCADO		130						●						
TPL-CI		130						●						
TBPL		130						●						
TPRA		131						●						
TPCA		131						●						
MOR		131							●					
TBH		131												
TPPM		131												
TPU		132												
TTC		132												















SOLAR

GB-SOLAR BLOCK SOPORTE		156												
GB-TER INOX A2 AISI-304		156												
VDF INOX A2 AISI-304		156												
TAP-N ALFOMBRILLA		157												
P-11 PLETINA INOX A2 AISI-304		157												
TORNILLO DIN-912 INOX A2 AISI-304		157												
TORNILLO DIN-933 INOX A2 AISI-304		157												
TORNILLO DIN-603 INOX A2 AISI-304		157												
TUERCA DIN-934 INOX A2 AISI-304		158												
TUERCA DIN-985 INOX A2 AISI-304		158												
TUERCA DIN-6923 INOX A2 AISI-304		158												
TUERCA INOX A2 ANTI-INTRUSIÓN		158												
DIN-125 INOX A2 AISI-304		158												
DIN-9021 INOX A2 AISI-304		158												







FIJACIONES PÓLVORA

STAGNO		159	CARGAS PARA GB35 y GB45		162
DIN-571 TBA-INOX A2	 	159	CABEZA Ø8 + ARANDELA Ø8		162
DIN-7504-K TBE-INOX A2	 	159	CLAVO CABEZA Ø8		163
AR-NE INOX A2 AISI-304	 	159	CABEZA Ø6 + ARANDELA Ø12		163
GB45 PISTOLA CLAVADORA		162			







REMACHES

REM-NO		166	REM-TIJ		168
REM-CA		166	REM-EXT		168
REM-BL		167	REM-TUER		168
REM-NE		167	TRE-AV		169
REM-FL		167	TRE-CA		169
REM-INOX A2	 	168	TRE-CR		169
REM-MAN		168			

ACCESORIOS CERCADOS

TENALZ		186	BPZ		186
TENALV		186	BTENZ		186
TENTOZ		186	TAZ • TAP • UÑA		187

BROCAS

GEBFOR PRO	 	190	GEDFOR TURBO 3	 	192
GEBFOR SDS PLUS	 	191			



CM		172
CM		172
CM		172
CM		172
CM		173
CM		173
CM		173
CM		173
CM		174
CM		174
CM		174
CM		174
CM		175
CM		175
CM		175
CM		175
CM		176
CM		176
CM		176
CM		176
CM		177
CM		177
CM		177
CM		177

CM		178
CM		178
CM		178
CM		178
CM		178
CM		178
CM		179
CM		179
CM		179
CM		179
CM		179
CM		180
CM		180
CM		180
CM		180
CM		181
CM		181
CM		181
CM		181
CM		182
CM		182
CM		182
CM		182
CM		183
CM		183
CM		183
CM		183
CM		183

CAJAS CON VENTANA
WINDOW BOX



CAJAS CON VENTANA

SITA TTS		194	DIN-7504-N TBRZ		197
SITA TTSI INOX A2 AISI-304		194	DIN-7504-P TBP		198
AC-TO		194	TAU		198
AC-TO INOX A2 AISI-304		194	DIN-7981 TR81		198
AC-AR		194	TCR		199
AC-GA		194	DIN-7982 TR82		199
BETA, TTB		195	DIN-571 TBA		199
Taco Latón OMEGA TLAT		195	TINVZ		199
MRR • MRH		195	TINVN		199
ANCLAJE LASTRO, TCR		195	TTXEB		200
RAPID RN		195	TTXEZ		200
RAPID RA-V		195	TTXE-A2 INOX A2 AISI-304		200
GL Nylon		195	DIN-7505-A TPOB		201
GL Nylon + TBA		196	DIN-7505-A TPOZ		201
GL Nylon + TPOB		196	TPL FOSFATADO		201
Taco GX-LVT GX-LVE		196	DIN-7505-A TTOB		202
Taco Nylon NUDO con collarín		196	REM-NO • REM-CA REM-FL		202
Taco TURBO JET /SV		196	PACA		203
TURBO JET / SVI INOX A2 AISI-304		196	PAES • PAGA		203
DIN-7504-K TBE		197	BCA		203
DIN-7504-K TBE+ARNE		197	BES • BGA		203
AR-NE AR-NE INOX A2		197	HA • HC • AR		204
			BR-BLANCA BR-NEGRA BR-VERDE		205
			BR-TACO BL BR-TACO NG		205

MAREFIX[®]
FIXING SYSTEMS
— by **G&B GROUP** —



CATÁLOGO 2025

G&B FISSAGGI ESPAÑA



SITA ACERO



SITA Acero TTS, Zincado

Anclaje macho AMN



DISPONIBLE CON ARANDELA DIN-9021.
CONSULTAR PRECIO Y PLAZO



DISPONIBLE CON ARANDELA CUELLO.
CONSULTAR PRECIO Y PLAZO



CÓDIGO CODE	MRF	MEDIDA SIZE	DESCR.	MAX.			€/ 100
TTS01	AMN06045	M-06x45	S645/5	5	200	1.000	27,92
* TTS02	AMN06055	M-06x55	S655/15	15	150	750	29,17
TTS661	AMN06060	M-06x60	S660/20	20	100	500	30,90
TTS670	AMN06070	M-06x70	S670/30	30	100	500	31,89
TTS680	AMN06080	M-06x80	S680/40	40	100	500	31,93
TTS24	AMN06090	M-06x90	S690/50	50	100	500	33,46
TTS6100	AMN06100	M-06x100	S6100/60	60	100	500	39,91
TTS6120	AMN06120	M-06x120	S6120/80	80	50	250	40,26
TTS6140	AMN06140	M-06x140	S6140/100	100	50	250	51,02
NEW TTS6160	AMN06160	M-06x160	S6160/120	120	50	250	68,79
TTS25	AMN08050	M-08x50	S850/5	5	100	500	34,10
TTS860	AMN08060	M-08x60	S860/15	15	100	500	34,93
* TTS96	AMN08065	M-08x65	S865/15	15	150	750	36,42
TTS05	AMN08075	M-08x75	S875/25	25	100	500	36,75
TTS890	AMN08090	M-08x90	S890/40	40	100	500	39,52
* TTS06	AMN08095	M-08x95	S895/45	45	100	500	41,54
TTS17	AMN08115	M-08x115	S8115/65	65	50	250	50,01
TTS8120	AMN08120	M-08x120	S8120/70	70	50	250	50,97
TTS8130	AMN08130	M-08x130	S8130/80	80	25	125	62,56
TTS8155	AMN08155	M-08x155	S8155/105	105	25	125	103,20
* TTS1065	AMN10065	M-10x65	S1065/1	1	70	350	50,89
TTS26	AMN10070	M-10x70	S1070/10	10	70	350	51,84
TTS1080	AMN10080	M-10x80	S1080/20	20	50	250	54,13
TTS08	AMN10090	M-10x90	S1090/30	30	50	250	57,81
TTS09	AMN10100	M-10x100	S10100/40	40	50	250	63,78
TTS18	AMN10120	M-10x120	S10120/60	60	40	200	69,27
TTS97	AMN10140	M-10x140	S10140/80	80	40	200	78,62
TTS095	AMN10150	M-10x150	S10150/90	90	40	200	87,60
TTS1017	AMN10170	M-10x170	S10170/110	110	40	200	125,13
TTS10210	AMN10210	M-10x210	S10210/150	150	10	50	159,05
TTS10230	AMN10230	M-10x230	S10230/170	170	10	50	177,74
* TTS1270	AMN12070	M-12x70	S1270/5	5	25	125	61,69
TTS1275	AMN12075	M-12x75	S1275/10	10	50	250	80,27
TTS1280	AMN12080	M-12x80	S1280/15	15	50	250	81,49
TTS1290	AMN12090	M-12x90	S1290/25	25	40	200	85,55
* TTS10	AMN12095	M-12x95	S1295/15	15	40	200	86,27
TTS12100	AMN12100	M-12x100	S12100/20	20	40	200	87,57
TTS19	AMN12110	M-12x110	S12110/30	30	40	200	89,13
TTS27	AMN12120	M-12x120	S12120/40	40	25	125	101,57
TTS98	AMN12140	M-12x140	S12140/60	60	25	125	112,36
TTS12	AMN12160	M-12x160	S12160/80	80	25	125	133,60
TTS12180	AMN12180	M-12x180	S12180/100	100	20	100	159,42
TTS121	AMN12200	M-12x200	S12200/120	120	20	100	178,00
TTS12220	AMN12220	M-12x220	S12220/140	140	20	80	209,15
TTS122	AMN12240	M-12x240	S12240/160	160	10	80	226,13
TTS12250	AMN12250	M-12x250	S12250/170	170	20	80	298,13
TTS93	AMN14100	M-14x100	S14100/5	5	20	100	167,02
TTS14120	AMN14120	M-14x120	S14120/25	25	20	100	187,30
TTS94	AMN14130	M-14x130	S14130/35	35	20	100	195,00
TTS14145	AMN14145	M-14x145	S14145/50	50	20	100	228,17
* TTS95	AMN14150	M-14x150	S14150/55	55	20	100	234,00
TTS14170	AMN14170	M-14x170	S14170/75	75	10	50	251,75
TTS1690	AMN16090	M-16x90	S1690/5	5	20	100	182,71
TTS28	AMN16110	M-16x110	S16110/5	5	20	100	203,42
TTS120	AMN16125	M-16x125	S16125/20	20	10	50	208,10
TTS20	AMN16145	M-16x145	S16145/40	40	10	50	211,00
TTS14	AMN16170	M-16x170	S16170/65	65	10	50	248,36
TTS1620	AMN16200	M-16x200	S16200/95	95	10	50	250,62
TTS29	AMN16220	M-16x220	S16220/115	115	5	40	310,18
TTS20120	AMN20120	M-20x120	S20120/5	5	5	25	400,12
* TTS99	AMN20130	M-20x130	S20130/5	5	5	25	418,30
TTS30	AMN20170	M-20x170	S20170/45	45	5	25	439,80
TTS2022	AMN20220	M-20x220	S20220/95	95	5	40	489,47
TTS31	AMN20270	M-20x270	S20270/145	145	5	30	655,59
TTS24180	AMN24180	M-24x180	S24180/10	10	10	20	1.148,55
TTS24260	AMN24260	M-24x260	S24260/80	80	10	20	1.581,23

(*) HASTA FINAL DE EXISTENCIAS

SITA ACERO



SITA Acero TTSI INOX A2 (AISI 304)

Anclaje macho AM-INOX A2

INOX (A2)



DISPONIBLE CON ARANDELA DIN-9021.
CONSULTAR PRECIO Y PLAZO



DISPONIBLE CON ARANDELA CUELLO.
CONSULTAR PRECIO Y PLAZO



CÓDIGO CODE	MRF	MEDIDA SIZE	DESCR.	MAX.	200g	500g	€ / 100
TTSI645	AMA206045	M-06x45	SI645/5	5	200	1.000	94,66
TTSI660	AMA206060	M-06x60	SI660/20	20	100	500	106,16
TTSI680	AMA206080	M-06x80	SI680/40	40	100	500	111,03
TTSI6120	AMA206120	M-06x120	SI6120/80	80	50	250	140,25
TTSI6140	AMA206140	M-06x140	SI6140/100	100	50	250	173,57
TTSI6160	AMA206160	M-06x160	SI6160/120	120	50	250	188,27
* TTSI6170	AMA206170	M-06x170	SI6170/130	130	50	250	253,00
* TTSI6180	AMA206180	M-06x180	SI6180/140	140	50	250	292,00
TTSI850	AMA208050	M-08x50	SI850/5	5	100	500	112,75
TTSI875	AMA208075	M-08x75	SI875/25	25	100	500	123,50
TTSI890	AMA208090	M-08x90	SI890/40	40	100	500	140,55
* TTSI895	AMA208095	M-08x95	SI895/45	45	100	500	222,00
TTSI8115	AMA208115	M-08x115	SI8115/65	65	50	250	227,00
TTSI1070	AMA210070	M-10x70	SI1070/10	10	70	350	191,10
TTSI1090	AMA210090	M-10x90	SI1090/30	30	50	250	213,91
TTSI1095	AMA210100	M-10x100	SI10100/40	40	50	250	225,00
TTSI10120	AMA210120	M-10x120	SI10120/60	60	40	200	256,42
TTSI10150	AMA210150	M-10x150	SI10150/90	90	40	200	357,41
TTSI1275	AMA212075	M-12x75	SI1275/10	10	50	250	362,00
TTSI1290	AMA212090	M-12x90	SI1290/25	25	40	200	307,51
TTSI1100	AMA212100	M-12x100	SI12100/20	20	40	200	320,00
TTSI1110	AMA212110	M-12x110	SI12110/30	30	40	200	338,87
* TTSI1120	AMA212120	M-12x120	SI12120/40	40	25	125	397,00
TTSI1140	AMA212140	M-12x140	SI12140/60	60	25	125	482,00
TTSI1160	AMA212160	M-12x160	SI12160/80	80	20	100	500,00
TTSI1690	AMA216090	M-16x90	SI1690/5	5	20	100	800,22
TTSI16125	AMA216125	M-16x125	SI16125/20	20	15	75	997,40
TTSI16145	AMA216145	M-16x145	SI16145/40	40	10	50	1.114,17
TTSI16170	AMA216170	M-16x170	SI16170/65	65	10	50	1.261,53
TTSI20120	AMA220120	M-20x120	SI20120/5	5	5	25	1.446,27
TTSI20170	AMA220170	M-20x170	SI20170/45	45	5	25	1.955,60
TTSI20220	AMA220220	M-20x220	SI20220/95	95	5	40	2.450,39

(*) HASTA FINAL DE EXISTENCIAS



SITA Acero GBKI CE 7 INOX A4 (AISI 316)

Homologación CE - Opción 7

INOX (A4)



ETA-17/0237
OPTION 7

on line
G&B CALCULATION PROGRAM 4.3
professional design of anchorage in concrete
PROGRAMA DE CÁLCULO



CÓDIGO CODE	MEDIDA SIZE	DESCR.	MAX.	200g	500g	€ / 100
60501	M-8x75	GBK1875/17	17	100	500	196,91
60502	M-8x95	GBK1895/37	37	100	500	220,08
60503	M-8x115	GBK18115/57	57	50	250	301,85
60504	M-10x90	GBK11090/25	25	50	250	336,60
60505	M-10x100	GBK110100/35	35	50	250	359,83
60506	M-10x120	GBK110120/55	55	50	250	407,62
60507	M-10x140	GBK110140/75	75	40	200	505,07
60508	M-12x100	GBK112100/18	18	40	200	575,82
60509	M-12x120	GBK112120/38	38	25	125	640,81
60510	M-12x140	GBK112140/58	58	25	125	770,58
60511	M-12x160	GBK112160/78	78	25	125	843,75
60512	M-16x125	GBK116125/10	10	20	100	1.370,74
60513	M-16x145	GBK116145/30	30	20	100	1.433,44
60514	M-16x170	GBK116170/55	55	10	50	1.999,53

SITA ACERO



piedra stone hormigón concrete hormigón fisurado cracked concrete

Certificado para
FIJACIONES EN ZONA SISMICA
CAT C1

SITA Acero TTSK CE 1 INOX A4 (AISI 316)

Homologación CE - Opción 1
para hormigón fisurado y no fisurado

INOX (A4)



ETA-10/0076
OPTION 1



CAT. C1 = M8+M16



on line

G&B CALCULATION PROGRAM 4.3

professional design of anchorage in concrete

PROGRAMA DE CÁLCULO

SOLICITAR HOMOLOGACIÓN

CÓDIGO CODE	MEDIDA SIZE	DESCR.	↓ MAX.			€/ 100
96001	M-8x72	SI1K872/10	10	50	250	353,76
96002	M-8x92	SI1K892/30	30	50	250	390,56
96003	M-8x112	SI1K8112/50	50	40	200	453,03
96004	M-10x92	SI1K1092/10	10	40	200	596,23
96024	M-10x102	SI1K10102/20	20	25	125	652,50
96005	M-10x112	SI1K10112/30	30	25	125	692,83
96006	M-10x132	SI1K10132/50	50	25	125	782,03
96025	M-12x103	SI1K12103/5	5	20	100	928,16
96007	M-12x118	SI1K12118/20	20	20	100	1.017,36
96008	M-12x128	SI1K12128/30	30	20	100	1.190,56
96026	M-12x148	SI1K12148/50	50	20	100	1.210,16
96009	M-12x163	SI1K12163/65	65	20	100	1.497,96
96010	M-16x123	SI1K16123/5	5	10	50	1.924,62
96027	M-16x138	SI1K16138/20	20	10	50	2.332,02
96011	M-16x168	SI1K16168/50	50	10	50	2.692,82



piedra stone hormigón concrete

SITA Acero GBK CE 7

Homologación CE - Opción 7
para hormigón no fisurado



ETA-17/0237
OPTION 7

on line

G&B CALCULATION PROGRAM 4.3

professional design of anchorage in concrete

PROGRAMA DE CÁLCULO



SOLICITAR HOMOLOGACIÓN

CÓDIGO CODE	MEDIDA SIZE	DESCR.	↓ MAX.			€/ 100
60322	M-8x65	GBK865/7	7	150	750	40,15
60323	M-8x75	GBK875/17	17	100	500	44,11
60324	M-8x95	GBK895/37	37	100	500	49,08
60325	M-8x115	GBK8115/57	57	50	250	57,86
NEW 60351	M-8x130	GBK8130/72	72	50	250	59,93
NEW 60352	M-8x155	GBK8155/97	97	70	350	69,73
NEW 60353	M-10x67	GBK1067/2	2	50	250	63,60
60326	M-10x75	GBK1075/10	10	70	350	71,82
60327	M-10x90	GBK1090/25	25	50	250	77,79
60328	M-10x100	GBK10100/35	35	50	250	83,04
NEW 60354	M-10x110	GBK10110/45	45	50	250	82,47
60329	M-10x120	GBK10120/55	55	50	250	97,51
60330	M-10x150	GBK10150/85	85	40	200	111,06
60331	M-10x170	GBK10170/105	105	40	200	129,54
NEW 60355	M-12x85	GBK1285/3	3	50	250	101,93
60348	M-12x90	GBK1290/8	8	50	250	107,19
60332	M-12x100	GBK12100/18	18	40	200	120,17
60333	M-12x110	GBK12110/28	28	40	200	126,43
60334	M-12x120	GBK12120/38	38	25	125	135,43
60335	M-12x140	GBK12140/58	58	25	125	149,59
60336	M-12x160	GBK12160/78	78	25	125	173,19
60337	M-12x180	GBK12180/98	98	20	100	175,25
NEW 60356	M-16x117	GBK16117/2	2	20	100	227,00
60341	M-16x125	GBK16125/10	10	20	100	242,54
60342	M-16x145	GBK16145/30	30	20	100	277,15
60343	M-16x170	GBK16170/55	55	10	50	302,92
60349	M-16x200	GBK16200/85	85	10	50	355,75
60344	M-16x220	GBK16220/105	105	5	40	376,96
60350	M-20x150	GBK20150/15	15	5	25	445,28
60345	M-20x170	GBK20170/35	35	5	25	468,55
60346	M-20x220	GBK20220/85	85	5	40	582,75
60347	M-20x270	GBK20270/135	135	5	30	743,04

SITA ACERO



pedra stone
hormigón concrete

SITA Acero GBK CE 7 extralargo

Homologación CE - Opción 7,
para hormigón no fisurado



on line
G&B CALCULATION PROGRAM 4.3
professional design
of anchorage in concrete
PROGRAMA DE CÁLCULO

ETA-17/0237
OPTION 7

CÓDIGO CODE	MEDIDA SIZE	DESCR.	↓ MAX.			€/ 100
60135	M-12x200	GBK12200/118	118	10	50	240,63
60136	M-12x220	GBK12220/138	138	10	80	257,33
60137	M-12x240	GBK12240/158	158	10	80	270,88
60138	M-12x280	GBK12280/198	198	10	60	349,38
60139	M-12x300	GBK12300/218	218	10	60	507,79
60140	M-12x360	GBK12360/278	278	10	60	968,98
60141	M-16x240	GBK16240/125	125	5	40	487,65
60142	M-16x280	GBK16280/165	165	5	30	538,67
60143	M-16x300	GBK16300/185	185	5	30	573,82
60144	M-16x400	GBK16400/285	285	5	30	1.629,64



pedra stone
hormigón concrete
hormigón fisurado cracked concrete

Certificado para
FIJACIONES EN ZONA SÍSMICA
CAT C1

SITA Acero TTSC CE 1

Homologación CE - Opción 1
para hormigón fisurado y no fisurado



ETA-20/0471
OPTION 1

CAT. C1 = M8÷M16



on line
G&B CALCULATION PROGRAM 4.3
professional design
of anchorage in concrete
PROGRAMA DE CÁLCULO

CÓDIGO CODE	MEDIDA SIZE	DESCR.	↓ MAX.			€/ 100
TTSC01	M-8x75	S1C875/20	20	50	250	88,74
TTSC02	M-8x95	S1C895/40	40	50	250	97,62
TTSC03	M-8x115	S1C8115/60	60	40	200	111,04
TTSC04	M-10x90	S1C1090/10	10	40	200	139,26
TTSC05	M-10x100	S1C10100/20	20	25	125	148,66
TTSC06	M-10x110	S1C10110/30	30	25	125	148,95
TTSC07	M-10x130	S1C10130/50	50	25	125	177,83
TTSC08	M-10x160	S1C10160/80	80	25	125	207,82
TTSC09	M-12x105	S1C12105/20	20	20	100	221,02
TTSC11	M-12x120	S1C12120/35	35	20	100	241,32
TTSC12	M-12x135	S1C12135/50	50	20	100	253,88
TTSC13	M-12x175	S1C12175/90	90	20	100	247,94
TTSC14	M-16x135	S1C16135/25	25	10	50	390,74
TTSC15	M-16x150	S1C16150/40	40	10	50	500,75
TTSC16	M-16x160	S1C16160/50	50	10	50	537,78



pedra stone
hormigón concrete
hormigón fisurado cracked concrete

Certificado para
FIJACIONES EN ZONA SÍSMICA
CAT C1 - CAT C2

SITA Acero TTSKS CE 1

Homologación CE - Opción 1
para hormigón fisurado y no fisurado



ETA-17/0481
OPTION 1

CAT. C1 = M10÷M20
CAT. C2 = M12÷M20



on line
G&B CALCULATION PROGRAM 4.3
professional design
of anchorage in concrete
PROGRAMA DE CÁLCULO

CÓDIGO CODE	MEDIDA SIZE	DESCR.	↓ MAX.			€/ 100
TTSKS05	M-10x105	S1KS10105/25	25	25	125	166,26
TTSKS06	M-10x115	S1KS10115/35	35	25	125	190,83
TTSKS07	M-10x135	S1KS10135/55	55	25	125	210,20
TTSKS10	M-12x100	S1KS12100/4	4	20	100	238,64
TTSKS12	M-12x120	S1KS12120/24	24	20	100	274,63
TTSKS13	M-12x130	S1KS12130/34	34	20	100	253,75
TTSKS14	M-12x150	S1KS12150/54	54	20	100	313,64
TTSKS15	M-12x180	S1KS12180/84	84	20	100	353,81
TTSKS17	M-16x145	S1KS16145/28	28	10	50	738,26
TTSKS20	M-20x170	S1KS20170/32	32	5	25	806,38
TTSKS21	M-20x200	S1KS20200/62	62	5	25	965,03

AC



AC-TO

Anclaje AC, tornillo, CALIDAD 6.8



ZINCADO

CÓDIGO CODE	MEDIDA SIZE	Ø	MAX.	REGAL	REGAL	€/ 100
ACTO08C	M-06 x 45	Ø08	5	200	1.200	29,65
ACTO08L	M-06 x 60	Ø08	15	200	800	34,75
ACTO10C	M-08 x 60	Ø10	5	100	600	47,50
ACTO10L	M-08 x 80	Ø10	15	100	600	55,80
ACTO12C	M-10 x 70	Ø12	5	100	400	75,90
ACTO12L	M-10 x 100	Ø12	25	50	300	94,00
ACTO14C	M-10 x 70	Ø14	5	100	400	96,60
ACTO14L	M-10 x 100	Ø14	25	50	300	117,40
ACTO16C	M-12 x 80	Ø16	5	50	200	147,15
ACTO16L	M-12 x 110	Ø16	25	50	200	178,55
ACTO20C	M-16 x 110	Ø20	15	25	100	324,90

AC-TO INOX A2 (AISI 304)

Anclaje AC, tornillo, INOX A2

INOX (A2)



INOXIDABLE A2

CÓDIGO CODE	MEDIDA SIZE	Ø	MAX.	REGAL	REGAL	€/ 100
ACTO208C	M-06 x 45	Ø08	5	200	1.200	106,51
ACTO208L	M-06 x 60	Ø08	15	200	800	117,98
ACTO210C	M-08 x 60	Ø10	5	100	600	169,17
ACTO210L	M-08 x 80	Ø10	15	100	600	198,19
ACTO212C	M-10 x 70	Ø12	5	100	400	285,40
ACTO212L	M-10 x 100	Ø12	25	50	300	349,04
ACTO214C	M-10 x 70	Ø14	5	100	400	379,65
ACTO214L	M-10 x 100	Ø14	25	50	300	423,44
ACTO216C	M-12 x 80	Ø16	5	50	200	562,71
ACTO216L	M-12 x 110	Ø16	25	50	200	712,07
ACTO220C	M-16 x 110	Ø20	15	25	100	1.461,91

AC-TO 8-8

Anclaje AC, tornillo, CALIDAD 8.8



ZINCADO

CÓDIGO CODE	MEDIDA SIZE	Ø	MAX.	REGAL	REGAL	€/ 100
ACTO8808C	M-06 x 45	Ø08	5	200	1.200	33,80
ACTO8808L	M-06 x 60	Ø08	15	200	800	39,35
ACTO8810C	M-08 x 60	Ø10	5	100	600	53,95
ACTO8810L	M-08 x 80	Ø10	15	100	600	63,50
ACTO8812C	M-10 x 70	Ø12	5	100	400	95,84
ACTO8812L	M-10 x 100	Ø12	25	50	300	107,05
ACTO8816C	M-12 x 80	Ø16	5	50	200	169,05
ACTO8816L	M-12 x 110	Ø16	25	50	200	205,35
* ACTO8820C	M-16 x 110	Ø20	15	25	100	371,55

(*) HASTA FINAL DE EXISTENCIAS

AC-PZ

Anclaje AC, CABEZA AVELLANADA



ZINCADO

CÓDIGO CODE	MEDIDA SIZE	Ø	Ø	MAX.	REGAL	REGAL	€/ 100
ACPZ08C	M-06x45	Ø08	4	5	100	1.200	46,01
ACPZ08L	M-06x60	Ø08	4	10	100	1.200	67,47
ACPZ10C	M-08x60	Ø10	5	5	100	600	75,61
ACPZ10L	M-08x80	Ø10	5	10	100	400	101,92
ACPZ12C	M-10x70	Ø12	6	5	50	300	133,87
ACPZ12L	M-10x100	Ø12	6	15	50	300	229,52

AC



AC-PI INOX A2 (AISI 304)
Anclaje AC, cabeza avellanada, **INOX A2**

INOX (A2)



INOXIDABLE A2

CÓDIGO CODE	MEDIDA SIZE	Ø	Ø	MAX.	100g	1.200g	€/ 100
ACPI08C	M-06x45	Ø08	4	5	100	1.200	102,60
ACPI08L	M-06x60	Ø08	4	10	100	1.200	124,80
ACPI10C	M-08x60	Ø10	5	5	100	600	183,87
ACPI10L	M-08x80	Ø10	5	10	100	400	217,67
ACPI12C	M-10x70	Ø12	6	5	50	300	290,75
ACPI12L	M-10x100	Ø12	6	15	50	300	361,33

AC-INZ

Anclaje AC, **CABEZA INVIOLEBLE**



ZINCADO

CÓDIGO CODE	MEDIDA SIZE	Ø	Ø	MAX.	100g	1.200g	€/ 100
ACINZ08C	M-06x45	Ø08	TX40	5	100	1.200	50,03
ACINZ08L	M-06x60	Ø08	TX40	15	100	800	57,34
ACINZ10C	M-08x60	Ø10	TX40	5	100	600	70,95
ACINZ10L	M-08x80	Ø10	TX40	15	100	400	83,68

AC-INN

Anclaje AC, **CABEZA INVIOLEBLE**



ZINCADO NEGRO

CÓDIGO CODE	MEDIDA SIZE	Ø	Ø	MAX.	100g	1.200g	€/ 100
ACINN08C	M-06x45	Ø08	TX40	5	100	1.200	60,96
ACINN08L	M-06x60	Ø08	TX40	15	100	800	68,30
ACINN10C	M-08x60	Ø10	TX40	5	100	600	82,06
ACINN10L	M-08x80	Ø10	TX40	15	100	400	98,55

AC-AR

Anclaje AC, **ARGOLLA**



ZINCADO

CÓDIGO CODE	MEDIDA SIZE	Ø	A	MAX.	100g	1.200g	€/ 100
ACAR08C	M-06x45	Ø08	10	5	100	600	50,91
ACAR10C	M-08x60	Ø10	13	5	100	400	82,14
ACAR12C	M-10x70	Ø12	14	5	50	200	131,51
ACAR14C	M-10x70	Ø14	14	5	50	200	152,28
ACAR16C	M-12x80	Ø16	22	5	25	100	243,66

AC-GA

Anclaje AC, **GANCHO**



ZINCADO

CÓDIGO CODE	MEDIDA SIZE	Ø	A	MAX.	100g	1.200g	€/ 100
ACGA08C	M-06x45	Ø08	10	5	100	600	50,91
ACGA10C	M-08x60	Ø10	13	5	100	400	82,14
ACGA12C	M-10x70	Ø12	14	5	50	200	131,51
ACGA14C	M-10x70	Ø14	14	5	50	200	152,28
ACGA16C	M-12x80	Ø16	22	5	25	100	243,66

AC



hormigón
concrete piedra
stone ladrillo macizo
solid brick

AC-AF

Anclaje AC, **ARGOLLA FORJADA**



ZINCADO

CÓDIGO CODE	MEDIDA SIZE	Ø	A	MAX.			€/ 100
ACAF08C	M-06x45	Ø8	10	5	100	600	97,95
ACAF10C	M-08x60	Ø10	11	5	100	400	127,95
ACAF12C	M-10x70	Ø12	14	5	50	200	197,32

AC-GF

Anclaje AC, **GANCHO FORJADO**



ZINCADO

CÓDIGO CODE	MEDIDA SIZE	Ø	A	MAX.			€/ 100
ACGF08C	M-06x45	Ø8	10	5	100	600	100,99
ACGF10C	M-08x60	Ø10	11	5	100	400	137,51
ACGF12C	M-10x70	Ø12	14	5	50	200	214,44

AC-AFI INOX A2 (AISI 304)

Anclaje AC, argolla forjada, **INOX A2**



INOX (A2)



INOXIDABLE A2

CÓDIGO CODE	MEDIDA SIZE	Ø	A	MAX.			€/ 100
ACAFI08C	M-06x45	Ø8	10	5	100	600	442,12
ACAFI10C	M-08x60	Ø10	11	5	100	400	705,25
ACAFI12C	M-10x70	Ø12	14	5	50	200	940,68

AC-GFI INOX A2 (AISI 304)

Anclaje AC, gancho forjado, **INOX A2**



INOX (A2)



INOXIDABLE A2

CÓDIGO CODE	MEDIDA SIZE	Ø	A	MAX.			€/ 100
ACGFI08C	M-06x45	Ø8	10	5	100	600	402,64
ACGFI10C	M-08x60	Ø10	11	5	100	400	598,08
ACGFI12C	M-10x70	Ø12	14	5	50	200	793,19

AC-GE

Anclaje AC, **GANCHO ESPIRAL**



ZINCADO

CÓDIGO CODE	MEDIDA SIZE	Ø	MAX.			€/ 100
ACGE10C	M-08x60	Ø10	5	25	150	178,13
ACGE12C	M-10x70	Ø12	5	15	90	238,00

AC-NTR

Anclaje NTR, **GANCHO REFORZADO**,
con arandela **DIN-9021**

**PARA REDES
ANTICAÍDA**

NEW



ZINCADO

CÓDIGO CODE	MEDIDA SIZE	Ø	MAX.			€/ 100
ASR-12	M-12x90	Ø18	5	10	80	368,07

ALFA ALM ACERO



Anclaje ALFA ALM



CÓDIGO CODE	CÁPSULA SHIELD	DESCR.		↓ MAX.			€/ 100
TM06	12x50	ALM6	M6	-	50	800	79,15
TM08	14x50	ALM8	M8	-	50	800	111,65
TM10	16x60	ALM10	M10	-	25	400	117,31
TM12	20x72	ALM12	M12	-	20	320	258,28

Anclaje ALFA ALM / V Con TORNILLO 8.8



Tornillo
Alta Calidad cl. 8.8

CÓDIGO CODE	CÁPSULA SHIELD	DESCR.	TORNILLO SCREW	↓ MAX.			€/ 100
TMV06	12x50	ALM6/V	M6x50	3	50	800	115,00
TMV08	14x50	ALM8/V	M8x60	9	50	400	142,38
TMV10	16x60	ALM10/V	M10x80	17	25	200	226,58
TMV12	20x72	ALM12/V	M12x90	15	20	160	428,00

Anclaje ALFA ALM / V Con TORNILLO 8.8 EXTRALARGO



Tornillo
Alta Calidad cl. 8.8

CÓDIGO CODE	CÁPSULA SHIELD	DESCR.	TORNILLO SCREW	↓ MAX.			€/ 100
TMV670	12x50	ALM670/V	M6x70	23	50	800	130,16
TMV685	12x50	ALM685/V	M6x85	38	50	400	120,07
TMV875	14x50	ALM875/V	M8x75	24	50	400	154,32
TMV890	14x50	ALM890/V	M8x90	39	50	400	172,84
TMV1085	16x60	ALM1085/V	M10x85	22	25	200	283,56
TMV1011	16x60	ALM10110/V	M10x110	47	25	200	308,19
TMV1013	16x60	ALM10130/V	M10x130	67	20	200	285,57
TMV1210	20x72	ALM12100/V	M12x100	25	15	120	382,03
TMV1211	20x72	ALM12115/V	M12x115	40	15	120	420,63
TMV1213	20x72	ALM12135/V	M12x135	60	20	160	444,33

Anclaje ALFA ALM / D Con TORNILLO 8.8, con PROLONGADOR y doble arandela



Tornillo
Alta Calidad cl. 8.8

CÓDIGO CODE	MEDIDA SIZE	DESCR.	TORNILLO SCREW	↓ MAX.			€/ 100
TMVD08	14x80	ALM8/80	M8x80	25	25	200	319,17
TMVD10	16x100	ALM10/100	M10x100	35	20	160	448,92

GAMMA ACERO CE 1



Certificado para
FIJACIONES EN ZONA SÍSMICA
CAT C1 - CAT C2

Anclaje GAMMA / V, CE 1

Para grandes cargas, tornillo, CALIDAD 8.8
Homologación CE - Opción 1
para hormigón fisurado



ETA-11/0181
OPTION 1



CAT. C1 = M6÷M16
CAT. C2 = M6÷M16



CÓDIGO CODE	MEDIDA SIZE	DESCR.			↓ MAX.			€/ 100
44077	10x70	HG10/70V	10	M6	5	50	400	351,48
44078	10x100	HG10/100V	10	M6	35	50	400	422,08
44079	12x100	HG12/100V	13	M8	30	25	200	552,87
44080	12x120	HG12/120V	13	M8	50	25	200	625,67
44081	16x120	HG16/120V	17	M10	40	20	160	825,00
44082	16x140	HG16/140V	17	M10	60	10	80	860,00
44083	18x120	HG18/120V	19	M12	20	15	120	1.158,13
44084	18x150	HG18/150V	19	M12	50	10	80	1.336,40
44085	24x140	HG24/140V	24	M16	20	5	40	2.677,80
44086	24x170	HG24/170V	24	M16	50	5	25	3.484,80



on line

G&B CALCULATION
PROGRAM .35

professional design
of anchorage in concrete
PROGRAMA DE CÁLCULO

SOLICITAR
HOMOLOGACIÓN

Anclaje GAMMA / VTS, CE 1

Para grandes cargas, tornillo, CALIDAD 8.8
Homologación CE - Opción 1
para hormigón fisurado



ETA-11/0181
OPTION 1



CAT. C1 = M6÷M12
CAT. C2 = M6÷M12



CÓDIGO CODE	MEDIDA SIZE	DESCR.			↓ MAX.			€/ 100
44112	10x85	HG10/85VTS	4	M6	20	50	400	526,20
44113	10x105	HG10/105VTS	4	M6	40	50	400	648,98
44114	12x105	HG12/105VTS	5	M8	35	25	200	757,33
44115	12x125	HG12/125VTS	5	M8	55	25	200	806,93
44116	16x110	HG16/110VTS	6	M10	30	20	160	1.140,93
44117	16x130	HG16/130VTS	6	M10	50	10	80	1.194,93
44118	18x120	HG18/120VTS	8	M12	20	15	120	1.681,80
44119	18x140	HG18/140VTS	8	M12	40	10	80	1.913,27



on line

G&B CALCULATION
PROGRAM .35

professional design
of anchorage in concrete
PROGRAMA DE CÁLCULO

SOLICITAR
HOMOLOGACIÓN



MATERIALES / MATERIALS

HORMIGÓN FISURADO
CRACKED CONCRETE

HORMIGÓN NO FISURADO
UNCRAKED CONCRETE



GETO PLUS SMK CE 1

Anclaje autorroscante certificado CE 1 para hormigón fisurado

CE OPTION 1

GETO PLUS SMK / TEF

Cabeza **HEXAGONAL**.

Homologación CE - Opción 1



OPTION 1



CAT. C1 = 8-10-14
CAT. C2 = 10-14



on line

G&B CALCULATION PROGRAM 4.3

professional design of anchorage in concrete
PROGRAMA DE CÁLCULO



Nueva rosca: Instalación más rápida y mejores prestaciones.

- Diámetros de perforación reducidos
- No se prescribe ningún par de apriete
- Es suficiente con la inserción completa del anclaje
- Sin fuerzas de dilatación, permite instalaciones cerca de los bordes
- Totalmente desmontable y reutilizable
- Para uso interno en seco y uso externo

ZINCADO

CÓDIGO CODE	MEDIDA SIZE	Ø	DESCR.	MAX.	TECG&B	TECG&B	€/ 100
* 87300	7,5x60	6	GPS-TEF6/60	10 20/5	100	1.200	87,95
* 87301	7,5x80	6	GPS-TEF6/80	10 40/25	100	1.200	101,81
* 87302	7,5x100	6	GPS-TEF6/100	10 60/45	50	800	130,03
* 87303	10,5x55	8	GPS-TEF8/55	13 5/-	50	800	146,13
* 87304	10,5x65	8	GPS-TEF8/65	13 15/5	50	600	159,04
* 87305	10,5x75	8	GPS-TEF8/75	13 25/15	50	800	170,88
* 87306	10,5x90	8	GPS-TEF8/90	13 40/30	50	800	182,85
* 87307	10,5x110	8	GPS-TEF8/110	13 60/50	30	480	230,51
* 87308	10,5x130	8	GPS-TEF8/130	13 80/70	30	360	257,65
* 87309	12,5x65	10	GPS-TEF10/65	15 5/-	30	360	257,23
* 87310	12,5x75	10	GPS-TEF10/75	15 15/5/-	30	360	283,41
* 87311	12,5x85	10	GPS-TEF10/85	15 25/15/-	30	360	311,47
* 87312	12,5x100	10	GPS-TEF10/100	15 40/30/15	20	320	360,80
* 87313	12,5x120	10	GPS-TEF10/120	15 60/50/35	20	240	404,64
* 87314	12,5x140	10	GPS-TEF10/140	15 80/70/55	20	240	450,08
* 87315	12,5x160	10	GPS-TEF10/160	15 100/90/75	30	210	508,11
* 87316	16,5x80	14	GPS-TEF14/80	18 5/-	12	144	664,05
* 87317	16,5x115	14	GPS-TEF14/115	18 40/5	12	144	831,31
* 87318	16,5x135	14	GPS-TEF14/135	18 60/25	10	120	910,13
* 87319	16,5x160	14	GPS-TEF14/160	18 85/50	10	70	1.059,57

(*) HASTA FINAL DE EXISTENCIAS

ZINCADO

CÓDIGO CODE	MEDIDA SIZE	Ø	DESCR.	MAX.	TECG&B	TECG&B	€/ 100
* 87320	7,5x72	6	GPS-TPS6/72	T30 32/17	100	1.200	108,00
* 87321	7,5x112	6	GPS-TPS6/112	T30 72/57	50	800	156,75
* 87322	7,5x132	6	GPS-TPS6/132	T30 92/77	50	800	196,21

(*) HASTA FINAL DE EXISTENCIAS

GETO PLUS SMK / TPS

Cabeza **PLANA AVELLANADA**.

Homologación CE - Opción 1



OPTION 1



CAT. C1 = 8-10-14
CAT. C2 = 10-14

on line

G&B CALCULATION PROGRAM 4.3

professional design of anchorage in concrete
PROGRAMA DE CÁLCULO

ZINCADO

CÓDIGO CODE	MEDIDA SIZE	Ø	DESCR.	MAX.	TECG&B	TECG&B	€/ 100
* 87323	7,7x42	6	GPS-TB6/42	T30 2/-	100	1.200	78,29

(*) HASTA FINAL DE EXISTENCIAS

GETO PLUS SMK / TB

Cabeza **EXTRAPLANA**.

Homologación CE - Opción 1



OPTION 1



CAT. C1 = 8-10-14
CAT. C2 = 10-14

on line

G&B CALCULATION PROGRAM 4.3

professional design of anchorage in concrete
PROGRAMA DE CÁLCULO

ZINCADO

CÓDIGO CODE	MEDIDA SIZE	Ø	DESCR.	MAX.	TECG&B	TECG&B	€/ 100
* 87324	7,5x75	6	GPS-DF6/55 M8/M10	13 15	100	0	288,96

(*) HASTA FINAL DE EXISTENCIAS

GETO PLUS SMK / DF

Con **ROSCA DOBLE COMBINADA**

Homologación CE - Opción 1



OPTION 1



professional design of anchorage in concrete
PROGRAMA DE CÁLCULO

GETO PLUS TMK CE 1

Anclaje autorroscante para instalaciones pasantes sobre soportes, incluidos los fisurados.

CE OPTION 1



Nueva rosca: instalación más rápida y alto rendimiento.

- **Instalación rápida y sencilla** gracias a la rosca optimizada
- **Cargas elevadas:** la geometría especial de la rosca garantiza una estanqueidad extrema y cargas elevadas en el hormigón (cargas de tracción o de corte).
- **Fijación segura incluso cerca de los bordes del soporte.**
- **Regulable durante el apriete y desmontable.** Indispensable para renovaciones.
- **Certificado para uso redundante no estructural**
- **Certificado para losas prefabricadas de hormigón alveolar pretensado.**

GETO PLUS TMK CE 1 TEF

Cabeza hexagonal con arandela.



OPTION 1 Ø7,5-Ø16,6
Fijación múltiple para usos no estructurales Ø6,3-Ø7,5

CAT. C1 Ø7,5-Ø16,6
CAT. C2 Ø7,5-Ø16,6

NEW

CÓDIGO CODE	MEDIDA SIZE	DESCR.			MAX.			€/100
TMKE05040	6,3x40	GPT-TEF 5x40	10	5	5	100	-	81,20
TMKE05060	6,3x60	GPT-TEF 5x60	10	5	25	100	-	84,27
TMKE06040	7,5x40	GPT-TEF 6x40	13	6	5/-	100	-	92,47
TMKE06060	7,5x60	GPT-TEF 6x60	13	6	25/20/5	100	-	93,67
TMKE06080	7,5x80	GPT-TEF 6x80	13	6	45/40/25	100	-	99,73
TMKE06100	7,5x100	GPT-TEF 6x100	13	6	65/60/45	100	-	123,13
TMKE08060	10,6x60	GPT-TEF 8x60	13	8	15/5/-	50	-	154,53
TMKE08070	10,6x70	GPT-TEF 8x70	13	8	25/15/5	50	-	159,80
TMKE08090	10,6x90	GPT-TEF 8x90	13	8	45/35/25	50	-	181,00
TMKE08100	10,6x100	GPT-TEF 8x100	13	8	55/45/35	50	-	192,93
TMKE08120	10,6x120	GPT-TEF 8x120	13	8	75/65/55	50	-	214,00
TMKE10060	12,6x60	GPT-TEF 10x60	15	10	5/-	50	-	233,00
TMKE10070	12,6x70	GPT-TEF 10x70	15	10	15/-	50	-	239,00
TMKE10080	12,6x80	GPT-TEF 10x80	15	10	25/5/-	50	-	244,93
TMKE10100	12,6x100	GPT-TEF 10x100	15	10	45/25/15	50	-	260,80
TMKE10120	12,6x120	GPT-TEF 10x120	15	10	65/45/35	50	-	297,87
TMKE10150	12,6x150	GPT-TEF 10x150	15	10	95/75/65	50	-	350,87
TMKE10160	12,6x160	GPT-TEF 10x160	15	10	105/85/75	50	-	391,73
TMKE12080	14,6x80	GPT-TEF 12x80	17	12	15/-	25	-	585,00
TMKE12110	14,6x110	GPT-TEF 12x110	17	12	45/25/10	25	-	642,53
TMKE14080	16,6x80	GPT-TEF 14x80	21	14	5/-	25	-	726,33
TMKE14110	16,6x110	GPT-TEF 14x110	21	14	35/10/-	25	-	861,07
TMKE14130	16,6x130	GPT-TEF 14x130	21	14	55/30/15	25	-	993,00
TMKE14150	16,6x150	GPT-TEF 14x150	21	14	75/50/35	25	-	1.194,40

Disponible bajo pedido en acero con recubrimiento de zinc laminar.

GETO PLUS TMKI CE 1 TEFI

Cabeza hexagonal con arandela. **INOX A4**

INOX (A4)



OPTION 1

CAT. C1 Ø7,5-Ø12,6

NEW

CÓDIGO CODE	MEDIDA SIZE	DESCR.			MAX.			€/100
TMKI06050	7,5x50	GPT-TEFI 6x50	13	6	15/5/-	100	-	673,36
TMKI06060	7,5x60	GPT-TEFI 6x60	13	6	25/15/5	100	-	723,58
TMKI08070	10,6x70	GPT-TEFI 8x70	13	8	25/15/5	50	-	855,60
TMKI08080	10,6x80	GPT-TEFI 8x80	13	8	35/25/15	50	-	885,50
TMKI10090	12,6x90	GPT-TEFI 10x90	15	10	35/15/5	50	-	1.207,35
TMKI10100	12,6x100	GPT-TEFI 10x100	15	10	45/25/15	50	-	1.256,49
TMKI10120	12,6x120	GPT-TEFI 10x120	15	10	65/45/35	50	-	1.373,87

GETO PLUS TMK CE 1

Anclaje autorroscante para instalaciones pasantes sobre soportes, incluidos los fisurados.



CE OPTION 1

GETO PLUS TMK CE 1 TPS

Cabeza plana avellanada, Ø13 mm



OPTION 1

Fijación múltiple para usos no estructurales



CAT. C1 Ø7,5



NEW

CÓDIGO CODE	MEDIDA SIZE	DESCR.			MAX.			€ / 100
TMKS06040	7,5x42	GPT-TPS 6x40	T30	6	6	100	-	83,07
TMKS06050	7,5x52	GPT-TPS 6x50	T30	6	6	100	-	87,80
TMKS06060	7,5x60	GPT-TPS 6x60	T30	6	6	100	-	98,33
TMKS06100	7,5x100	GPT-TPS 6x100	T30	6	6	100	-	128,67
TMKS06120	7,5x130	GPT-TPS 6x120	T30	6	6	100	-	140,67
TMKS06140	7,5x152	GPT-TPS 6x140	T30	6	6	100	-	178,13

GETO PLUS TMK CE 1 TB

Cabeza alomada, Ø14,5 mm



OPTION 1

Fijación múltiple para usos no estructurales



CAT. C1 Ø7,5



NEW

CÓDIGO CODE	MEDIDA SIZE	DESCR.			MAX.			€ / 100
TMKTB06040	7,5x40	GPT-TB 6x40	T30	6	5/-/-	100	-	72,59

GETO PLUS TMK CE 1 TL

Cabeza alomada grande, Ø18 mm



OPTION 1

Fijación múltiple para usos no estructurales



CAT. C1 Ø7,5



NEW

CÓDIGO CODE	MEDIDA SIZE	DESCR.			MAX.			€ / 100
TMKTL06040	7,5x40	GPT-TL 6x40	T30	6	5/-/-	100	-	74,99
TMKTL06060	7,5x60	GPT-TL 6x60	T30	6	25/20/5	100	-	82,40

GETO PLUS TMK CE 1 DF

Con doble rosca combinada M8/M10

Para fijación con varillas roscadas, soportes de tubos, collarines, canales suspendidos, etc.



3 PIEZAS PREMONTADAS



OPTION 1

Fijación múltiple para usos no estructurales



CAT. C1 Ø7,5



NEW

CÓDIGO CODE	MEDIDA SIZE	DESCR.			MAX.			€ / 100
TMKDF06035	7,5x35	GPT-DF 6x35	13	6	0/-/-	50	-	153,12
TMKDF06065	7,5x55	GPT-DF 6x55	13	6	20/15/0	50	-	154,45

TORNILLO HORMIGÓN TH



hormigón
concrete

hormigón ligero
aerated concrete



SOLICITAR
FICHA TÉCNICA

THCH

Tornillo para hormigón, cabeza hexagonal, rosca hi-lo, punta diamante

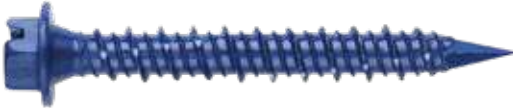

Acabado: AZUL RUSPERT

CÓDIGO CODE	MEDIDA SIZE	Ø	MAX.				€/ 100
THCH65032	6,5 x 32	Ø 5	2	8 + Ranura	1.000	3.000	14,57
THCH65045	6,5 x 45	Ø 5	15	8 + Ranura	500	2.000	17,90
THCH65057	6,5 x 57	Ø 5	27	8 + Ranura	500	2.000	23,09
THCH65070	6,5 x 70	Ø 5	40	8 + Ranura	500	1.500	29,50
THCH65080	6,5 x 80	Ø 5	50	8 + Ranura	250	1.000	35,14
THCH65100	6,5 x 100	Ø 5	70	8 + Ranura	250	1.000	42,96
THCH65115	6,5 x 115	Ø 5	85	8 + Ranura	250	1.000	48,65
THCH65125	6,5 x 125	Ø 5	95	8 + Ranura	250	1.000	56,81
THCH65150	6,5 x 150	Ø 5	120	8 + Ranura	250	1.000	66,81
THCH65180	6,5 x 180	Ø 5	150	8 + Ranura	100	300	107,49
THCH65200	6,5 x 200	Ø 5	170	8 + Ranura	100	300	137,73

THCH+ARNE

Montado con arandela EPDM P-16



Acabado: AZUL RUSPERT

CÓDIGO CODE	MEDIDA SIZE	Ø	MAX.				€/ 100
THCH1665032	6,5 x 32 / P16	Ø 5	2	8 + Ranura	1.000	2.000	22,33
THCH1665045	6,5 x 45 / P16	Ø 5	15	8 + Ranura	500	1.500	26,30
THCH1665057	6,5 x 57 / P16	Ø 5	27	8 + Ranura	500	1.500	32,07
THCH1665070	6,5 x 70 / P16	Ø 5	40	8 + Ranura	500	1.500	36,30
THCH1665080	6,5 x 80 / P16	Ø 5	50	8 + Ranura	250	750	43,68
THCH1665100	6,5 x 100 / P16	Ø 5	70	8 + Ranura	250	750	51,12
THCH1665115	6,5 x 115 / P16	Ø 5	85	8 + Ranura	250	500	59,54
THCH1665125	6,5 x 125 / P16	Ø 5	95	8 + Ranura	250	500	64,86
THCH1665150	6,5 x 150 / P16	Ø 5	120	8 + Ranura	250	500	76,90
THCH1665180	6,5 x 180 / P16	Ø 5	150	8 + Ranura	200	400	121,66
THCH1665200	6,5 x 200 / P16	Ø 5	170	8 + Ranura	125	250	155,88

Montados con ARANDELA EPDM P-18

THCH1865032	6,5 x 32 / P18	Ø 5	2	8 + Ranura	500	1.500	24,33
THCH1865045	6,5 x 45 / P18	Ø 5	15	8 + Ranura	500	1.500	28,42



TORNILLO HORMIGÓN GETO INFISSO



Tornillo hormigón GETO INFISSO GS

Cabeza **AVELLANADA**, zincado.
Huella TX30



CÓDIGO CODE	TORNILLO SCREW	DESCR.	∅ HORMIGÓN	∅ LADRILLO			€/ 100
TVGS17	7,5x52	GS 52	6,5	6	100	1.000	22,10
TVGS31	7,5x62	GS62	6,5	6	100	1.000	28,73
TVGS20	7,5x72	GS72	6,5	6	100	1.000	33,28
TVGS29	7,5x82	GS82	6,5	6	100	1.000	35,83
TVGS21	7,5x92	GS92	6,5	6	100	1.000	41,08
TVGS18	7,5x102	GS102	6,5	6	100	1.000	44,99
TVGS22	7,5x112	GS112	6,5	6	100	1.000	46,35
TVGS28	7,5x122	GS122	6,5	6	100	800	52,73
TVGS23	7,5x132	GS132	6,5	6	100	800	54,69
TVGS24	7,5x152	GS152	6,5	6	100	800	64,77
TVGS25	7,5x182	GS182	6,5	6	100	600	81,13
TVGS30	7,5x212	GS212	6,5	6	100	600	93,58
TVGS27	7,5x252	GC252	6,5	6	100	600	303,94
TVGS32	7,5x302	GC302	6,5	6	50	300	488,80

Tornillo hormigón GETO INFISSO GC

Cabeza **CILÍNDRICA**, zincado.
Huella TX15 - Ø5 | TX30 - Ø7,5



CÓDIGO CODE	TORNILLO SCREW	DESCR.	∅ HORMIGÓN	∅ LADRILLO			€/ 100
TVGC07	5x62	GC5-62	4	4	100	1.600	37,38
TVGC08	5x82	GC5-82	4	4	100	1.600	46,04
TVGC01	5x102	GC5-102	4	4	100	1.600	55,68
TVGC16	7,5x52	GC52	6,5	6	100	1.000	22,10
TVGC23	7,5x62	GC62	6,5	6	100	1.000	28,73
TVGC10	7,5x72	GC72	6,5	6	100	1.000	33,28
TVGC17	7,5x82	GC82	6,5	6	100	1.000	35,83
TVGC11	7,5x92	GC92	6,5	6	100	1.000	41,08
TVGC18	7,5x102	GC102	6,5	6	100	1.000	44,99
TVGC12	7,5x112	GC112	6,5	6	100	1.000	46,35
TVGC19	7,5x122	GC122	6,5	6	100	800	52,73
TVGC13	7,5x132	GC132	6,5	6	100	800	54,69
TVGC14	7,5x152	GC152	6,5	6	100	800	64,77
TVGC15	7,5x182	GC182	6,5	6	100	600	81,13
TVGC21	7,5x212	GC212	6,5	6	100	600	93,58
TVGC22	7,5x252	GC252	6,5	6	100	600	303,94
TVGC20	7,5x302	GC302	6,5	6	50	300	488,80

Tornillo hormigón GETO INFISSO GC-DE

Cabeza **CILÍNDRICA**, deltatone. Huella TX30.
Acabado: DELTATONE 1.000 Horas



NEW

CÓDIGO CODE	TORNILLO SCREW	DESCR.	∅ HORMIGÓN	∅ LADRILLO			€/ 100
TVGCDE10	7,5x72	GCDE-72	6,5	6	100	1.000	62,81
TVGCDE11	7,5x92	GCDE-92	6,5	6	100	1.000	76,16
TVGCDE12	7,5x112	GCDE-112	6,5	6	100	1.000	85,00
TVGCDE13	7,5x132	GCDE-132	6,5	6	100	800	97,88
TVGCDE14	7,5x152	GCDE-152	6,5	6	100	800	112,96
TVGCDE15	7,5x182	GCDE-182	6,5	6	100	600	136,84

Tapón para GETO INFISSO TX30

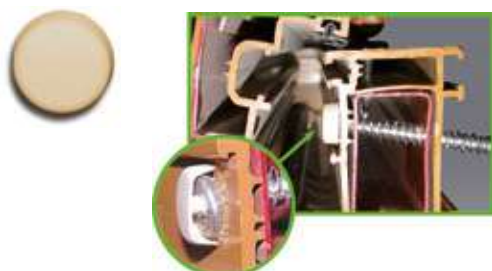

CÓDIGO CODE	MEDIDA SIZE	DESCR.	RAL			€/ 100
HCL01	TX30	CL BLANCO	9016	100	500	9,30
HCL02	TX30	CL NEGRO	-	100	500	9,30
HCL03	TX30	CL GRIS	7040	100	500	9,30
HCL04	TX30	CL MARFIL	1014	100	500	9,30
HCL05	TX30	CL MARRÓN OSC.	8017	100	500	9,30
HCL06	TX30	CL MARRÓN	1019	100	500	9,30

BETA

Anclaje hembra BETA, TTBCE

Homologación CE - Opción 7



pedra stone
hormigón concrete



on line



professional design of anchorage in concrete
PROGRAMA DE CÁLCULO



OPTION 7
M8=M20



Fijación múltiple para usos no estructurales M6=M12



SOLICITAR HOMOLOGACIÓN

CÓDIGO CODE	MEDIDA SIZE	∅	DESCR.	↓ MAX.			€ / 100
*TTBCE06	M-6x25	∅8	BCE06	-	100	2.000	21,76
TTBCE08	M-8x30	∅10	BCE08	-	100	2.000	27,55
TTBCE10	M-10x40	∅12	BCE10	-	50	1.000	57,25
TTBCE12	M-12x50	∅15	BCE12	-	50	500	89,32
**TTBCE16	M-16x65	∅20	BCE16	-	25	200	226,86

* Solo fijación múltiple para usos no estructurales

** Solo Opción 7

Anclaje hembra BETA, TTBLCE

Con Reborde. Homologación CE - Opción 7



on line



professional design of anchorage in concrete
PROGRAMA DE CÁLCULO



OPTION 7
M8=M20



Fijación múltiple para usos no estructurales M6=M12



SOLICITAR HOMOLOGACIÓN

CÓDIGO CODE	MEDIDA SIZE	∅	DESCR.	↓ MAX.			€ / 100
*TTBLCE06	M-6x25	∅8	BLCE06	-	100	2.000	32,56
TTBLCE08	M-8x30	∅10	BLCE08	-	100	2.000	41,24
TTBLCE10	M-10x40	∅12	BLCE11	-	50	1.000	62,56
TTBLCE12	M-12x50	∅15	BLCE12	-	50	500	120,43
**TTBLCE16	M-16x65	∅20	BLCE16	-	25	200	257,09

* Solo fijación múltiple para usos no estructurales

** Solo Opción 7



Anclaje hembra BETA, TTB



CÓDIGO CODE	MRF	MEDIDA SIZE	∅	DESCR.			€ / 100
TTB06	AHNM06	M-6x25	∅8	B6	100	2.000	14,00
TTB08	AHNM08	M-8x30	∅10	B8	100	2.000	19,32
TTB10	AHNM10	M-10x40	∅12	B10	50	1.000	27,84
TTB12	AHNM12	M-12x50	∅15	B12	50	500	47,70
TTB16	AHNM16	M-16x65	∅20	B16	25	250	112,59
TTB20	AHNM20	M-20x80	∅25	B20	25	100	257,00

Anclaje hembra BETA, TTBL

Con Reborde



CÓDIGO CODE	MRF	MEDIDA SIZE	∅	DESCR.			€ / 100
TTBL06	AHCM06	M-6x25	∅8	BL6	100	1.600	22,52
TTBL08	AHCM08	M-8x30	∅10	BL8	100	1.600	28,96
TTBL11	AHCM10	M-10x40	∅12	BL10	50	800	42,38
TTBL12	AHCM12	M-12x50	∅16	BL12	50	400	75,20
TTBL16	AHCM16	M-16x65	∅20	BL16	25	200	242,12

Anclaje hembra BETA, TTBI INOX A4 (AISI 316)



CÓDIGO CODE	MRF	MEDIDA SIZE	∅	DESCR.			€ / 100
TTBI06	AHA4M06	M-6x25	∅8	B6 A4	100	1.600	105,12
TTBI08	AHA4M08	M-8x30	∅10	B8 A4	100	1.600	143,58
TTBI10	AHA4M10	M-10x40	∅12	B10 A4	50	800	247,23
TTBI12	AHA4M12	M-12x50	∅15	B12 A4	50	400	429,61
TTBI16	AHA4M16	M-16x65	∅20	B16 A4	25	200	940,94
TTBI20	AHA4M20	M-20x80	∅25	-	25	100	1.748,59

EXPANSIONADOR

Para anclajes BETA



CÓDIGO CODE	MRF	DESCR.				€ / 100
TK51	AHVAR06	EXPANSIONADOR	M6	1	5	198,00
TK52	AHVAR08	EXPANSIONADOR	M8	1	5	198,00
TK53	AHVAR10	EXPANSIONADOR	M10	1	5	372,00
TK54	AHVAR12	EXPANSIONADOR	M12	1	5	414,00
TK55	AHVAR16	EXPANSIONADOR	M16	1	5	768,00

OMEGA LATÓN



Taco OMEGA Latón, TLAT



CÓDIGO CODE	MRF	MEDIDA SIZE	DIÁMETRO DIAMETER			€/ 100
TT0532	TLAT532	5/32 W x 16	5	200	7.200	12,33
TT004	TLATM04	M-04 x 16	5	200	7.200	12,56
TT005	TLATM05	M-05 x 22	7	200	7.200	20,72
TT006	TLATM06	M-06 x 24	8	200	2.000	28,56
TT008	TLATM08	M-08 x 30	10	100	2.000	51,28
TT010	TLATM10	M-10 x 35	12	100	1.400	77,84
TT012	TLATM12	M-12 x 40	15	100	800	161,78

Taco OMEGA Latón, TTO

Con esfera interna

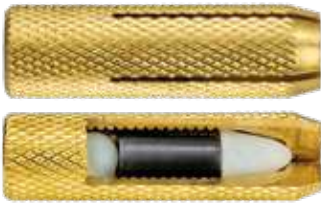

CÓDIGO CODE	MEDIDA SIZE	DIÁMETRO DIAMETER	DESCR.			€/ 100
TTO06LE	M-6x30	8	OM6LE	100	3.200	58,30
TTO08LE	M-8x40	11	OM8LE	100	1.600	134,00
TTO10LE	M-10x48	14	OM10LE	50	800	282,96

MRR

Manguito roscado, REDONDO



ZINCADO

CÓDIGO CODE	MEDIDA SIZE	DIÁMETRO DIAMETER			€/ 100
MRRZ5322	5/32Wx20	8	200	3.200	23,08
MRRZ0420	M-04x20	8	200	3.200	15,49
MRRZ0620	M-06x20	10	200	1.600	15,52
MRRZ0630	M-06x30	10	200	1.600	23,06
MRRZ0825	M-08x25	11	200	1.600	19,65
MRRZ0830	M-08x30	11	200	1.600	23,15
MRRZ1030	M-10x30	13	150	600	26,81
MRRZ1235	M-12x35	15	100	400	45,30
MRRZ1650	M-16x50	22	50	200	161,67

MRH

Manguito roscado, HEXAGONAL



ZINCADO

CÓDIGO CODE	MRF	MEDIDA SIZE				€/ 100
38620	MRHZ0620	M-06x20	10	200	1.600	16,73
38192	MRHZ0630	M-06x30	10	200	1.600	24,26
38825	MRHZ0825	M-08x25	11	200	1.600	19,65
38830	MRHZ0830	M-08x30	11	200	1.600	23,15
38193	MRHZ0840	M-08x40	11	120	1.200	29,80
38103	MRHZ1030	M-10x30	13	150	600	26,95
38194	MRHZ1045	M-10x45	13	75	300	81,20
38300	MRHZ1235	M-12x35	17	100	400	66,80
38195	MRHZ1250	M-12x50	17	50	200	73,00
38197	MRHZ1650	M-16x50	24	50	200	169,56
38199	MRHZ2060	M-20x60	30	50	100	430,19

FIJACIONES PARA ANDAMIOS



piedra stone hormigón concrete hormigón fisurado cracked concrete hormigón hueco concrete hollow block ladrillo macizo solid brick semimacizo semi-solid brick ladrillo hueco hollow brick



ARGOLLA OP12 / 23

Ø interno 23 mm



ZINCADO

CÓDIGO CODE	MRF	DESCR.			€/ 100
TOC1290	ANAN2309	12x90 / Ø23	-	25	168,92
TOC1212	ANAN2312	12x120 / Ø23	-	25	177,10
TOC1216	ANAN2316	12x160 / Ø23	-	20	214,65
TOC1219	ANAN2319	12x190 / Ø23	-	20	246,49
TOC1223	ANAN2323	12x230 / Ø23	-	20	283,91
TOC1230	ANAN2330	12x300 / Ø23	-	20	385,39
TOC1235	ANAN2335	12x350 / Ø23	-	20	441,58
TOC1240	-	12x400 / Ø23	-	20	550,90
TOC1245	-	12x450 / Ø23	-	20	598,79
TOC1250	-	12x500 / Ø23	-	20	657,04

ARGOLLA OP12 / 50

Ø interno 50 mm



ZINCADO

CÓDIGO CODE	MRF	DESCR.			€/ 100
TOC121450	ANAN5114	12/140 / Ø50	-	20	296,94
TOC121650	ANAN5116	12/160 / Ø50	-	20	324,16
TOC122050	ANAN5120	12/200 / Ø50	-	20	419,83
TOC122550	-	12/250 / Ø50	-	20	462,48
TOC123050	-	12/300 / Ø50	-	20	609,54



piedra stone hormigón concrete ladrillo macizo solid brick

ARGOLLA OP50

Ø interno 50 mm



ZINCADO

CÓDIGO CODE	MEDIDA SIZE	DESCR.			€/ 100
TOC5021	16x120	16/210 / Ø50	-	10	1.080,98
TOC5027	16x170	16/270 / Ø50	-	10	1.567,50

ANCLAJE ALFA ALM

Recambio para Argolla OP50



ZINCADO

CÓDIGO CODE	MEDIDA SIZE	DESCR.			€/ 100
TM10	16x60	ALM10	25	400	178,52

ARANDELA ANCHA 16x48



ZINCADO

CÓDIGO CODE	MEDIDA SIZE	DESCR.			€/ 100
TRR16	16x48	R16	50	400	52,53

FIJACIONES PARA ANDAMIOS



pedra stone hormigón concrete ladrillo macizo solid brick

TACO NYLON CONDOR



NYLON ALTA CALIDAD

CÓDIGO CODE	MEDIDA SIZE	DESCR.			€ / 100
HTC1410	Ø14x100	C14A100	40	320	30,16
HTC1614	Ø16x140	C16A140	25	150	124,16

Testado en el INSTITUTO POLITÉCNICO de Turín



pedra stone hormigón concrete hormigón fisurado cracked concrete hormigón armado reinforced concrete hormigón hueco concrete hollow block ladrillo macizo solid brick ladrillo hueco hollow brick

AND-TACO 8

Taco de nylon, ocho alas



NEW

CÓDIGO CODE	MEDIDA SIZE			€ / 100
TN8A14130	14 x 130	20	240	62,74
TN8A14160	14 x 160	20	120	68,96

TAPÓN CP CABEZA Ø28

Para tacos Ø14, Ø16, Ø18 mm



CÓDIGO CODE	DESCR.			€ / 100
HCL26	CP12 / Ø28	25	400	26,32

EXTRACTOR DINAMÓMETRO

Tester portátil para probar extracciones y resistencias de tacos y anclajes

CÓDIGO CODE	DESCR.			€ / 1
EXTR01	EXTRACTOR ANALÓGICO 0-25kN	1	1	7.733,33
EXTR02	EXTRACTOR DIGITAL 0-25kN	1	1	9.533,33



- Para argollas andamio
- Para varillas de M8-M16
- Para cabezas Ø16 a Ø32
- Para tacos nylon Ø8 y Ø10
- Capacidad de trabajo **25kN (2500 kg)**

LASTRO ACERO

Para paredes huecas y cartón-yeso



hormigón hueco
concrete hollow block

yeso laminado
plasterboard



ANCLAJE LASTRO, CS

Cuerpo solo



ZINCADO

CÓDIGO CODE	MRF	MEDIDA SIZE	DESCR.	→↔			€/ 100
48089	HWASI435	M-4x35 Ø8	L4-35	4-9	100	800	19,97
48090	HWASI537	M-5x37 Ø10	L5-37	5-13	100	800	26,79
48091	HWASI550	M-5x50 Ø10	L5-50	5-18	100	800	30,86
48092	HWASI563	M-5x63 Ø10	L5-63	16-32	100	800	42,45
48093	HWASI637	M-6x37 Ø11	L6-37	4-13	100	800	33,17
48094	HWASI650	M-6x50 Ø11	L6-50	5-18	50	400	37,57
48095	HWASI663	M-6x63 Ø11	L6-63	16-32	50	400	40,32
48096	HWASI837	M-8x37 Ø14,50	L8-37	4-12	50	400	50,11
48097	HWASI853	M-8x53 Ø14,50	L8-53	5-18	50	400	58,96
48098	HWASI866	M-8x66 Ø14,50	L8-66	18-32	50	400	70,84

ANCLAJE LASTRO, TH

Tornillo hexagonal



ZINCADO

CÓDIGO CODE	MRF	MEDIDA SIZE	TORNILLO SCREW	⇕ MAX.	→↔			€/ 100
48100	HWAHE837	M-8x37 Ø14,5	M8x45	12	4-12	50	600	75,40
48101	HWAHE853	M-8x55 Ø14,5	M8x60	18	5-18	50	600	88,46
48102	HWAHE866	M-8x66 Ø14,5	M8x73	32	18-32	25	300	111,80

ANCLAJE LASTRO, TCR

Tornillo cabeza redonda



ZINCADO

CÓDIGO CODE	MRF	MEDIDA SIZE	TORNILLO SCREW	⇕ MAX.	→↔			€/ 100
48083	HWACO423	M4x23 Ø8	M4x30	4	0-4	100	800	20,85
48084	HWACO435	M4x35 Ø8	M4x41	9	4-9	100	800	24,20
48011	HWACO440	M4x40 Ø8	M4x46	12	9-15	200	1.600	25,91
48063	HWACO446	M4x46 Ø8	M4x65	15	15-20	200	1.600	28,99
48085	HWACO460	M4x60 Ø8	M4x67	38	30-38	100	800	42,68
48055	HWACO537	M5x37 Ø10	M5x46	12	5-13	200	1.600	33,22
48012	HWACO550	M5x50 Ø10	M5x57	8	5-18	100	800	38,78
48062	HWACO563	M5x63 Ø10	M5x70	8	18-32	100	800	47,19
48060	HWACO580	M5x80 Ø10	M5x98	8	35-49	100	800	57,20
48059	HWACO637	M6x37 Ø11	M6x44	6	4-13	100	800	44,39
48013	HWACO650	M6x50 Ø11	M6x57	8	5-18	50	400	49,45
48014	HWACO663	M6x63 Ø11	M6x70	20	16-32	50	400	56,98
48070	HWACO680	M6x80 Ø11	M6x88	30	33-49	50	400	68,15
48086	HWACO837	M8x37 Ø14,5	M8x45	12	4-12	100	800	71,83
48087	HWACO853	M8x53 Ø14,5	M8x60	18	5-18	50	400	76,40
48088	HWACO866	M8x66 Ø14,5	M8x73	32	18-32	50	400	94,82



LASTRO ACERO

Para paredes huecas y cartón-yeso



hormigón hueco yeso laminado
concrete hollow block plasterboard

ANCLAJE LASTRO, GR

Gancho recto



ZINCADO

CÓDIGO CODE	MEDIDA SIZE	DESCR.	TORNILLO SCREW	⇕ MAX.	↔			€/ 100
48015	M-4x40 Ø8	L4-46/5	M4x46	12	9-15	50	400	35,52
48016	M-5x50 Ø10	L5-57/5	M5x57	8	5-18	100	800	55,20

ANCLAJE LASTRO, AR

Argolla



ZINCADO

CÓDIGO CODE	MEDIDA SIZE	DESCR.	TORNILLO SCREW	⇕ MAX.	↔			€/ 100
48017	M-4x40 Ø8	L4-46/4	M4x46	12	9-15	100	800	32,02
48018	M-5x50 Ø10	L5-57/4	M5x57	8	5-18	100	800	55,76

ANCLAJE LASTRO, GA

Gancho



ZINCADO

CÓDIGO CODE	MEDIDA SIZE	DESCR.	TORNILLO SCREW	⇕ MAX.	↔			€/ 100
48019	M-4x40 Ø8	L4-46/3	M4x46	12	9-15	100	800	29,76
48020	M-5x50 Ø10	L5-57/3	M5x57	8	5-18	100	800	52,48

Pinza LK



CÓDIGO CODE	MRF	DESCR.	TORNILLO SCREW	⇕ MAX.			€/ 100
TK30	HWAPISTO	LK	-	-	1	8	2.418,00



BASCULANTES PALOMILLAS



hormigón hueco
concrete hollow block

ladrillo hueco
hollow brick

yeso laminado
plasterboard

Basculante ANCORA, Reforzado DR



DR1-M6
DR3-M8

DR2-M6
DR4-M8

Palomilla ANCORA, Reforzada DE

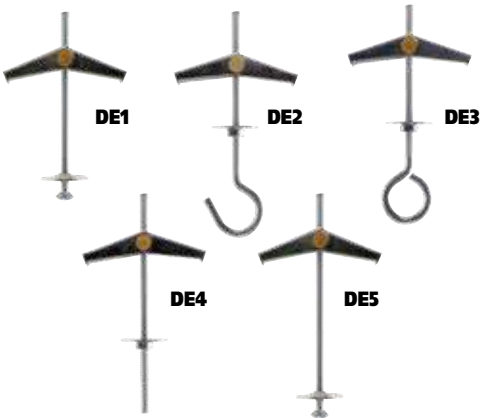

DE1

DE2

DE3

DE4

DE5

PACA

CABEZA de palomilla



PAES

Palomilla **ESPIGA**

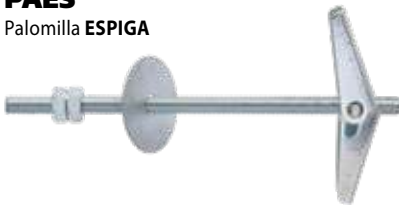

PAGA

Palomilla **GANCHO**

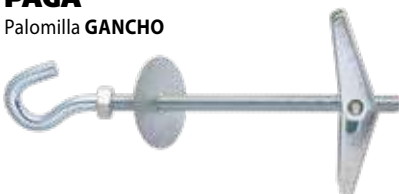

ZINCADO

CÓDIGO CODE	MEDIDA SIZE	DESCR.	TORNILLO SCREW	MAX.			€/ 100
HAN11	16	DR1	M6x100	-	25	200	128,40
HAN12	16	DR2	M6x100	-	25	200	131,67
HAN13	20	DR3	M8x115	-	20	160	243,87
HAN14	20	DR4	M8x100	-	20	160	243,87

ZINCADO

CÓDIGO CODE	MEDIDA SIZE	DESCR.	TORNILLO SCREW	MAX.			€/ 100
HAN01	14	DE1	M4x80	-	50	400	78,67
HAN02	14	DE2	M4x75	-	50	400	93,07
HAN03	14	DE3	M4x75	-	50	400	94,67
HAN04	14	DE4	M4x100	-	50	400	94,80
HAN05	15	DE5	M4x100	-	50	400	87,47

ZINCADO

CÓDIGO CODE	MEDIDA SIZE			€/ 100
PACA04	M-04	100	2.400	17,40
PACA05	M-05	100	1.200	18,16
PACA06	M-06	100	600	23,74
PACA08	M-08	100	400	48,05



ZINCADO

CÓDIGO CODE	MEDIDA SIZE			€/ 100
PAES04	M-04x75	50	300	44,52
PAES05	M-05x95	50	300	49,32
PAES06	M-06x100	50	200	61,51
PAES08	M-08x100	50	150	109,48



ZINCADO

CÓDIGO CODE	MEDIDA SIZE			€/ 100
PAGA04	M-04x75	50	300	47,66
PAGA05	M-05x95	50	300	53,39
PAGA06	M-06x100	50	200	72,80
PAGA08	M-08x100	50	150	121,02



BASCULANTES PALOMILLAS



hormigón hueco ladrillo hueco yeso laminado
concrete hollow block hollow brick plasterboard



BCA

CABEZA de basculante



ZINCADO

CÓDIGO CODE	MEDIDA SIZE			€ / 100
BCAM04	M-04	100	1.200	32,53
BCAM05	M-05	100	1.200	34,85
BCAM06	M-06	100	600	39,50
BCAM08	M-08	100	400	65,41

BES

Basculante **ESPIGA**



ZINCADO

CÓDIGO CODE	MEDIDA SIZE			€ / 100
BESM04	M-04x100	50	300	63,10
BESM05	M-05x100	50	300	68,58
BESM06	M-06x100	50	200	83,37
BESM08	M-08x100	50	200	134,43

BGA

Basculante **GANCHO**



ZINCADO

CÓDIGO CODE	MEDIDA SIZE			€ / 100
BGAM04	M-04x75	50	300	66,94
BGAM05	M-05x80	50	300	71,44
BGAM06	M-06x85	50	200	89,28
BGAM08	M-08x90	50	150	146,54



TACO RAPID

Para placas de Cartón-Yeso



yeso laminado
plasterboard



SOLICITAR
FICHA TÉCNICA

TAPLA - Nylon, TN



CÓDIGO CODE	MEDIDA SIZE	↓ MAX.			€ / 100
* TAPLA1233	12x33	-	100	1.600	10,46

(*) HASTA FINAL DE EXISTENCIAS



P. 195

Taco RAPID Nylon, RN



CÓDIGO CODE	MEDIDA SIZE	DESCR.	TORNILLO SCREW	↓ MAX.			€ / 100
HRN01	16x38	RN	-	-	200	1.600	14,53

Taco RAPID Nylon, RN-V

Con tornillo



CÓDIGO CODE	MEDIDA SIZE	DESCR.	TORNILLO SCREW	↓ MAX.			€ / 100
HRNV01	16x38	RN/V	4x50	12	150	1.200	19,20



hormigón ligero
aerated concrete

yeso laminado
plasterboard

Taco RAPID Zamak, RA



CÓDIGO CODE	MEDIDA SIZE	DESCR.	TORNILLO SCREW	↓ MAX.			€ / 100
90001	13x31	RA	-	-	200	3.200	22,86



P. 195

Taco RAPID Zamak, RA-V

Con tornillo



CÓDIGO CODE	MEDIDA SIZE	DESCR.	TORNILLO SCREW	↓ MAX.			€ / 100
90002	13x31	RA-V	4,5x30	5	100	1.600	27,00

STYLO FIX

Fijación de acero para placas de yeso.
Adecuado para diferentes diámetros
de tornillos para tableros de
aglomerado (Ø 3,5 a 5 mm)

- CABEZA PLANA para montaje empotrado con la superficie de soporte
- FIJACIÓN SIN PERFORAR gracias a la punta dentada
- SIMPLE Y RÁPIDO
- SIN ROTACIÓN Fácil atornillado gracias al perfil guía
- RESISTENTE AL FUEGO
- Fácil DESMONTAJE sin dañar el soporte



STYLO FIX

taco de metal

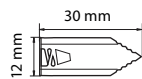

NEW

CÓDIGO CODE	MEDIDA SIZE	DESCR.		↓ MAX.			€ / 100
90019	12x30	STY	-	3-13	100	3.200	36,78

STYLO FIX

taco de metal con tornillo de cabeza avellanada



NEW

CÓDIGO CODE	MEDIDA SIZE	DESCR.		↓ MAX.			€ / 100
90020	12x30	STY-V	4x40	3-13	100	1.600	43,01



piedra
stone hormigón
concrete



SOLICITAR
FICHA TÉCNICA

SITA TTS

Anclaje de suspensión macho con anilla estampada.
Agujero Ø6



ZINCADO

CÓDIGO CODE	MRF	MEDIDA SIZE	DESCR.			€/ 100
TTS660	TIWIZ06060	M-6x60	S06	100	1.600	25,34

CE-AN

Anclaje cuña para techo



SOLICITAR
FICHA TÉCNICA

ZINCADO

CÓDIGO CODE	MEDIDA SIZE			€/ 100
CEANZ06035	6x35 Ø 6	100	1.200	22,00
CEANZ06065	6x65 Ø 6	100	1.200	34,04



piedra
stone hormigón
concrete hormigón ligero
aerated concrete



SOLICITAR
FICHA TÉCNICA

TARAS

Taco Rastrel



ZINCADO

CÓDIGO CODE	MEDIDA SIZE					€/ 100
TARAS6050	6x50	Ø6	20	200	2.400	16,57
TARAS6060	6x60	Ø6	30	200	1.200	17,28
TARAS6080	6x80	Ø6	50	200	1.200	19,84
TARAS8070	8x70	Ø8	30	100	1.200	27,24
TARAS8090	8x90	Ø8	50	100	600	32,53
TARAS8110	8x110	Ø8	70	100	600	38,48
TARAS8130	8x130	Ø8	90	100	600	48,16
TARAS8150	8x150	Ø8	110	100	600	53,99
NEW TARAS8180	8x180	Ø8	140	100	600	61,40
NEW TARAS8200	8x200	Ø8	160	50	300	79,64



SITA ACERO TTSI

**ANCLAJE MACHO AM,
PARA CARGAS ALTAS
THROUGH BOLT ANCHOR
FOR HEAVY LOADS**



**HORMIGÓN
CONCRETE**



**HORMIGÓN ARMADO
REINFORCED CONCRETE**



**PIEDRA
STONE**



Fijaciones destinadas a ser utilizadas en los materiales de construcción más comunes, para cargas medias y ligeras.

Fixadores destinados a serem utilizados nos materiais de construção mais comuns, para âncoras ligeiras e médias.

Fasteners intended for use on most common building materials, for light and medium anchors.



BI·FIX

la revolución de la fijación

A revolução na fixação / The revolution in fixing

el **BI-componente** multiexpansión para todos los materiales de construcción

o **BI-componente** de multi-expansão para todos os materiais de construção / The multiexpansion **BI-component** for all building materials



Gracias a la tecnología de **2 materiales** y al **diseño exclusivo**:

- Seguridad de instalación perfecta
- Valores de carga elevados
- 1 solo taco para todos tus proyectos

Rapidez y facilidad de utilización
También para **placas de cartón-yeso**
Alta capacidad de carga



Grças à tecnologia de 2 materiais e desenho exclusivo:

- Segurança de instalação perfeita
- Valores de carga elevados
- 1 única cavilha para todos os seus projetos

Rápido e fácil de usar
Também para painéis de gesso cartonado
Alta capacidade de carga

Thanks to 2-material technology and exclusive design:

- Perfect installation safety
- High load values
- 1 single plug for all your projects

Fast and easy to use
Also for plaster board panels
High load capacity



PATENTADO
PATENTEADO / PATENTED

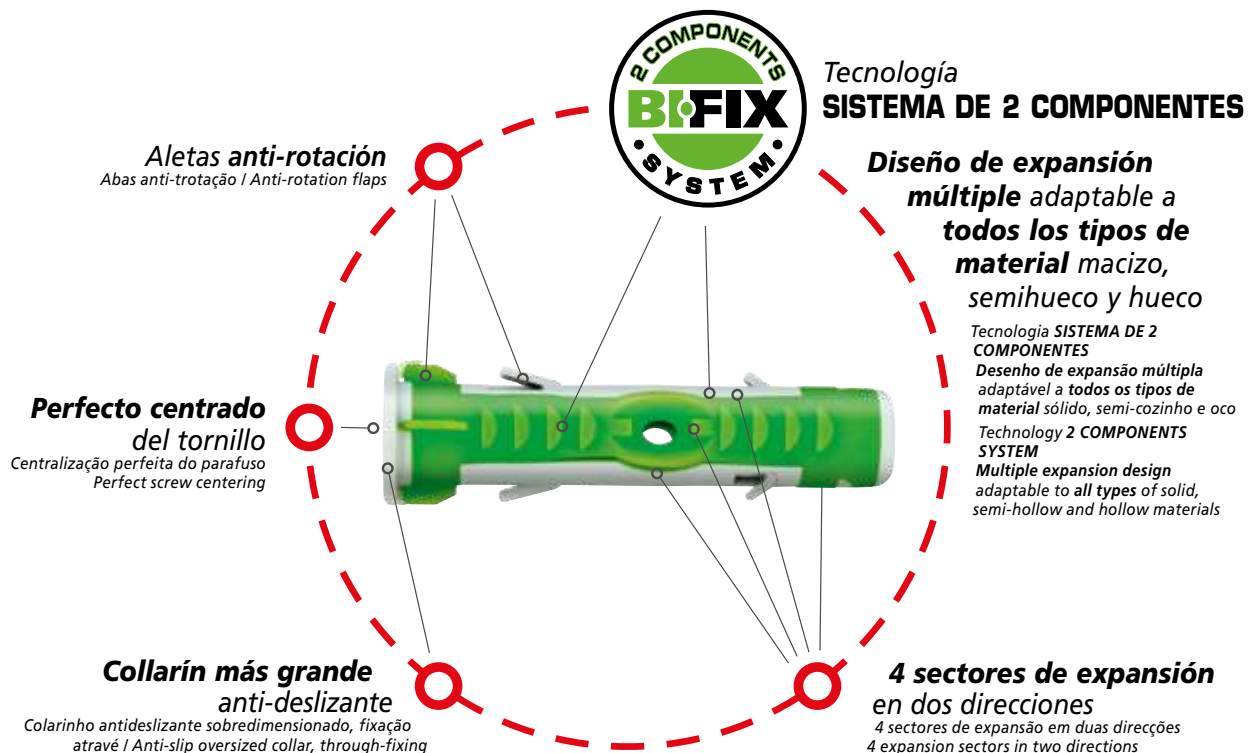

SUJECCIÓN EXTREMA + MÁXIMA ADAPTABILIDAD =
LA FIJACIÓN PERFECTA PARA CADA SITUACIÓN

FIXAÇÃO EXTREMA + MÁXIMA ADAPTABILIDADE = O AJUSTE PERFEITO PARA CADA SITUAÇÃO | EXTREME TIGHTNESS + MAXIMUM ADAPTABILITY = THE PERFECT FIXING FOR EVERY SITUATION

BI-FIX



Taco BI-FIX



CÓDIGO CODE	MEDIDA SIZE	DESCR.			€/100
18100	5x27	BF5-27	200	3.200	11,66
18105	6x35	BF6-35	200	3.200	12,87
18110	8x45	BF8-45	100	1.600	17,05
18115	10x50	BF10-50	75	1.200	23,10

**Taco BI-FIX
en bote**



CÓDIGO CODE	DESCR.			€/1
18150	BI-FIX Ø06x35 mm	600	6	84,87
18155	BI-FIX Ø08x45 mm	250	6	51,70

**Taco BI-FIX
Con tornillo TPS**



NEW	CÓDIGO CODE	MEDIDA SIZE	DESCR.		↓ MAX. ↑			€/100
	18120	5x27	BF5-27V	4x30	5	150	2.400	15,95
	18125	6x35	BF6-35V	4,5x40	10	150	2.400	17,82
	18130	8x45	BF8-45V	5x50	10	75	1.200	24,20
	18135	10x50	BF10-50V	6x60	10	50	800	35,70

**Bote EASY-BOX
Reutilizable**



NEW	CÓDIGO CODE	MEDIDA SIZE	DESCR.		↓ MAX. ↑			€/1
	18140	6x35	BF6-35V	4,5x40	10	250	6	48,13
	18145	8x45	BF8-45V	5x50	10	100	6	29,32

Expositor Taco BI-FIX

ESELF 38
Taco BI-FIX



ARTÍCULO ARTICLE	CÓDIGO CODE	DESCR.	CONTENIDO CONTENTS	€/1
* ESELF 38	-	BI-FIX Ø06x35 mm	7 x 150	365,48
	-	BI-FIX Ø08x45 mm	11 x 75	

(*) HASTA FINAL DE EXISTENCIAS

ESELF 38

GL NYLON

- Cuerpo de 4 sectores para mayor adaptabilidad al material base.
- Collarín elástico especial que permite la fijación a través.
- Nuevas medidas Ø 6x45mm y Ø 8x50 mm.



**NYLON
ALTA CALIDAD
HIGH QUALITY**



Taco GL, Nylon



POLIAMIDA 6.6

CÓDIGO CODE	MRF	MEDIDA SIZE	DESCR.			€/100
65001	TGX0525	5x25	GL5	200	6.400	2,61
65002	TGX0630	6x30	GL6	200	6.400	3,16
65115	-	6x45	GL645	100	3.200	5,61
65003	TGX0840	8x40	GL8	150	2.400	5,34
65116	TGX0850	8x50	GL850	100	1.600	9,46
65004	TGX1050	10x50	GL10	75	1.200	10,03
65017	TGX1260	12x60	GL12	25	400	17,93
65018	TGX1470	14x70	GL14	25	400	23,38

Taco GL, Nylon

Envasado industrial

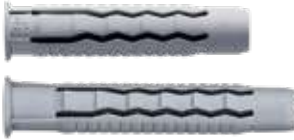

POLIAMIDA 6.6

CÓDIGO CODE	MEDIDA SIZE	DESCR.			€/100
65009	5x25	GL5	1.000	10.000	2,70
65010	6x30	GL6	1.000	10.000	3,14
65117	6x45	GL645	1.000	10.000	4,38
65011	8x40	GL8	500	10.000	5,83
65118	8x50	GL850	500	5.000	7,94
65012	10x50	GL10	250	5.000	10,71
65019	12x60	GL12	125	2.500	16,33
65020	14x70	GL14	50	2.000	25,96

Taco GL, Nylon

En cubo de plástico

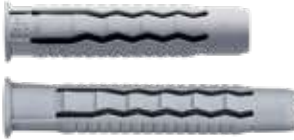

POLIAMIDA 6.6

CÓDIGO CODE	MRF	MEDIDA SIZE		€/1
65159	TGX0630BP	Ø 6 x 30	1.000	29,85
65160	TGX0840BP	Ø 8 x 40	500	27,76
65161	TGX1050BP	Ø 10 x 50	300	30,21
65162	TGX1260BP	Ø 12 x 60	150	24,22

Taco GL, Nylon

Con tornillo TPS

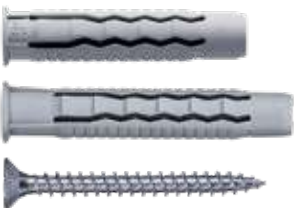

POLIAMIDA 6.6

NEW CÓDIGO CODE	MRF	MEDIDA SIZE		↓ MAX.			€/100
65005	GL5VPS	5x25	4x30	5	100	3.200	7,21
65006	GL6VPS	6x30	4,5x40	10	100	3.200	8,64
65119	GL645VPS	6x45	4,5x50	20	100	1.600	11,06
65007	GL8VPS	8x40	5x50	10	50	1.600	13,81
65120	GL850VPS	8x50	5x60	20	50	800	18,32
65008	GL10VPS	10x50	6x60	10	50	800	23,38

Bote EASY-BOX

Reutilizable



1 broca de widia de Ø6 x 100 o de Ø8 x 120 **GRATIS**



POLIAMIDA 6.6

NEW CÓDIGO CODE	MRF	MEDIDA SIZE		↓ MAX.			€/1
65089	GL6VPS BOTE	6x30	4,5x40	10	300	6	29,87
65090	GL8VPS BOTE	8x40	5x50	10	150	6	26,59

CONDOR NYLON



pedra stone hormigón concrete hormigón ligero aerated concrete hormigón hueco concrete hollow



ladrillo macizo solid brick semimacizo semi-solid brick ladrillo hueco hollow brick yeso laminado plasterboard

**NYLON
ALTA CALIDAD
HIGH QUALITY**



SOLICITAR FICHA TÉCNICA

Taco CONDOR, Nylon



POLIAMIDA 6.6

CÓDIGO CODE	MRF	MEDIDA SIZE	DESCR.			€/100
HTC04	TANY04	4x20	C04	200	6.400	2,69
HTC05	TANY05	5x25	C05	200	6.400	2,20
HTC06	TANY06	6x30	C06	200	6.400	2,59
HTC07	TANY07	7x30	C07	150	4.800	4,60
HTC08	TANY08	8x40	C08	100	3.200	4,94
HTC10	TANY10	10x50	C10	50	800	8,32
HTC12	TANY12	12x60	C12	50	800	14,82
HTC14	TANY14	14x80	C14	25	400	23,00
HTC1410	TANY14L	14x100	C14A100	40	320	30,16
HTC1680	TANY16	16x80	-	10	500	119,35

Taco CONDOR, Nylon

Envasado Industrial



POLIAMIDA 6.6

CÓDIGO CODE	MRF	MEDIDA SIZE	DESCR.			€/100
HTC50	TANY05GR	5x25	C05	1.000	10.000	1,97
HTC60	TANY06GR	6x30	C06	1.000	10.000	2,16
HTC80	TANY08GR	8x40	C08	500	10.000	4,52
HTC100	TANY10GR	10x50	C10	250	5.000	7,43
HTC120	TANY12GR	12x60	C12	125	2.500	13,01
HTC140	TANY14GR	14x80	C14	50	2.000	21,98

Taco CONDOR, Nylon

Bote de plástico



POLIAMIDA 6.6

CÓDIGO CODE	MEDIDA SIZE	DESCR.			€/1
25163	6x30	C6	1.500	4	42,76
25164	8x40	C8	800	4	42,68

Taco CONDOR, con reborde



POLIAMIDA 6.6

CÓDIGO CODE	MRF	MEDIDA SIZE	DESCR.			€/100
HTCB05	TANYCO05	5x25	CB05	200	6.400	4,26
HTCB06	TANYCO06	6x30	CB06	200	6.400	3,76
HTCB08	TANYCO08	8x40	CB08	100	3.200	6,26
HTCB10	TANYCO10	10x50	CB10	50	800	13,69
HTCB12	TANYCO12	12x60	CB12	25	400	22,69

Taco CONDOR, con reborde

Envasado Industrial



POLIAMIDA 6.6

CÓDIGO CODE	MEDIDA SIZE	DESCR.			€/100
HTCB50	5x25	CB05	1.000	10.000	3,14
HTCB60	6x30	CB06	1.000	10.000	3,20
HTCB80	8x40	CB08	500	10.000	4,79
HTCB100	10x50	CB10	250	5.000	8,02
HTCB120	12x60	CB12	125	2.500	17,11



piedra stone hormigón concrete hormigón ligero aerated concrete hormigón hueco concrete hollow ladrillo adobe adobe brick ladrillo macizo solid brick semimacizo semi-solid brick ladrillo hueco hollow brick yeso laminado plasterboard

Taco TAPLAS, polipropileno



POLIPROPILENO

CÓDIGO CODE	MEDIDA SIZE			€/ 100
TAPRO05	Ø 5x20	25	1.000	1,93
TAPRO06	Ø 6x22	25	1.000	2,04
TAPRO07	Ø 7x23	25	1.000	2,31
TAPRO08	Ø 8x25	25	1.000	2,59
TAPRO09	Ø 9x30	25	1.000	3,74
TAPRO10	Ø 10x40	25	1.000	4,79
TAPRO12	Ø 12x50	25	1.000	8,14
TAPRO14	Ø 14x50	25	1.000	11,99



hormigón hueco concrete hollow ladrillo hueco hollow brick yeso laminado plasterboard

ANCORA

Taco de nylon, para placas de cartón yeso y cavidades



POLIAMIDA 6.6

CÓDIGO CODE	MEDIDA SIZE	↓ MAX.			€/ 100
* TANCORA40	10x40 Ø 10	4 - 12	100	600	9,95
* TANCORA47	10x47 Ø 10	15 - 19	100	600	10,67

(*) HASTA FINAL DE EXISTENCIAS

Taco nylon NUDO, con reborde



POLIAMIDA 6.6

CÓDIGO CODE	MEDIDA SIZE		↓ MAX.			€/ 100
* TANUDO06	6x35	TPO Ø 3,5 - 4,0	10	150	2.400	3,27
* TANUDO08	8x50	TPO Ø 4,0 - 4,5	12	80	1.200	5,92
* TANUDO10	10x60	TPO Ø 5,0 - 6,0	11	50	800	9,97

(*) HASTA FINAL DE EXISTENCIAS

NYLON UNIVERSAL

Taco Nylon UNIVERSAL, con reborde



POLIAMIDA 6.6

CÓDIGO CODE	MEDIDA SIZE	DESCR.			€/ 100
* HNU06	6x35	NU6/35	200	3.200	4,66
* HNU08	8x42	NU8/42	100	1.600	7,53
* HNU080	8x50	NU8/50	50	800	11,82
* HNU10	10x60	NU10/60	50	800	15,86

(*) HASTA FINAL DE EXISTENCIAS

Taco Nylon UNIVERSAL

Invasado industrial



POLIAMIDA 6.6

CÓDIGO CODE	MEDIDA SIZE	DESCR.			€/ 100
* HNU60	6x35	NU6/35	1.000	5.000	3,46
* HNU80	8x42	NU8/42	500	5.000	5,05
* HNU0800	8x50	NU8/50	500	5.000	6,50
* HNU100	10x60	NU10/60	250	2.500	10,96

(*) HASTA FINAL DE EXISTENCIAS



SOLICITAR FICHA TÉCNICA

GBU NYLON

Taco GBU Nylon, con collarín



POLIAMIDA 6.6

CÓDIGO CODE	MEDIDA SIZE	DESCR.			€/ 100
* HGBU06	6x40	GBU6	200	3.200	4,91
* HGBU08	8x50	GBU8	100	1.600	10,45
* HGBU10	10x60	GBU10	50	800	15,85

(*) HASTA FINAL DE EXISTENCIAS

Taco GBU Nylon, con collarín

Invasado industrial



POLIAMIDA 6.6

CÓDIGO CODE	MEDIDA SIZE	DESCR.			€/ 100
* HGBU60	6x40	GBU6	1.000	5.000	3,71
* HGBU80	8x50	GBU8	500	5.000	6,75
* HGBU100	10x60	GBU10	250	2.500	10,95

(*) HASTA FINAL DE EXISTENCIAS

CASA NYLON

Taco CASA, GR

Con GANCHO RECTO



POLIAMIDA 6.6

CÓDIGO CODE	MEDIDA SIZE	DESCR.		MAX.			€/ 100
* HTS02	9x40	CA9-40/2	M4	-	100	800	39,55
* HTL02	12x45	CA12-45/2	M5	-	50	400	60,61

(*) HASTA FINAL DE EXISTENCIAS

Taco CASA, GA

Con GANCHO



POLIAMIDA 6.6

CÓDIGO CODE	MEDIDA SIZE	DESCR.		MAX.			€/ 100
* HTS05	9x40	CA9-40/5	M4	-	100	800	40,80
* HTL05	12x45	CA12-45/5	M5	-	50	400	62,37

(*) HASTA FINAL DE EXISTENCIAS

Taco CASA, AR

Con ARGOLLA



POLIAMIDA 6.6

CÓDIGO CODE	MEDIDA SIZE	DESCR.		MAX.			€/ 100
* HTS06	9x40	CA9-40/6	M4	-	100	800	42,08
* HTL06	12x45	CA12-45/6	M5	-	50	400	67,05

(*) HASTA FINAL DE EXISTENCIAS

Taco CASA, TO

Con TORNILLO



POLIAMIDA 6.6

CÓDIGO CODE	MEDIDA SIZE	DESCR.		MAX.			€/ 100
* HTS07	9x40	CA9-40/7	M4x50	8	150	1.200	36,74
* HTL07	12x45	CA12-45/7	M5x55	5	100	800	48,51

(*) HASTA FINAL DE EXISTENCIAS

GX-L NYLON

DISEÑO G&B



pedra stone, hormigón concrete, hormigón hueco concrete hollow, ladrillo macizo solid brick, semimacizo semi-solid brick, ladrillo hueco hollow brick



Rapporto n. 007QI/12

Taco GX-L / VT

Con **TORNILLO AVELLANADO**
Huella TX30 y TX40
Tornillo Ø 5,5mm **cementado**
Tornillo Ø 7mm **acero 5.8**
Homologación CE



P.196



ETAG 020
ETA 12-0261



GX-L
Ø10mm

on line



professional design
of anchorage in concrete
PROGRAMA DE CÁLCULO



SOLICITAR
HOMOLOGACIÓN

POLIAMIDA 6.6 - ZINCADO

CÓDIGO CODE	MRF	MEDIDA SIZE	DESCR.			MAX.			€/ 100
97258	-	6x60	GXL660VT	4x45	T20	20	150	1.200	23,10
97005	TGXA08080	8x80	GXL880VT	5,5x85	T30	10	75	600	55,85
97006	TGXA08100	8x100	GXL8100VT	5,5x105	T30	30	50	400	65,65
97007	TGXA08120	8x120	GXL8120VT	5,5x125	T30	50	50	400	75,65
97035	TGXA08140	8x140	GXL8140VT	5,5x145	T30	70	50	400	94,31
97177	TGXA08170	8x170	GXL8170VT	5,5x175	T30	100	50	400	142,31
97178	TGXA08200	8x200	GXL8200VT	5,5x205	T30	130	50	300	197,88
97008	TGXA10080	10x80	GXL1080VT	7x85	T40	10	50	400	71,03
97009	TGXA10100	10x100	GXL10100VT	7x105	T40	30	40	320	81,76
97010	TGXA10120	10x120	GXL10120VT	7x125	T40	50	50	400	97,23
97011	TGXA10140	10x140	GXL10140VT	7x145	T40	70	50	400	120,36
97012	TGXA10160	10x160	GXL10160VT	7x165	T40	90	50	400	138,36
97013	TGXA10200	10x200	GXL10200VT	7x205	T40	130	25	150	199,59
97014	TGXA10240	10x240	GXL10240VT	7x245	T40	170	20	120	261,92
97015	TGXA10260	10x260	GXL10260VT	7x265	T40	190	20	120	291,18

Taco GX-L / VTI

Con **TORNILLO AVELLANADO**
huella TX30 y TX40
INOX A4 (AISI 316)
Homologación CE



ETAG 020
ETA 12-0261



GX-L
Ø10mm

on line



professional design
of anchorage in concrete
PROGRAMA DE CÁLCULO



SOLICITAR
HOMOLOGACIÓN

POLIAMIDA 6.6 - INOX A4

CÓDIGO CODE	MRF	MEDIDA SIZE	DESCR.			MAX.			€/ 100
97175	TGXA108080	8x80	GXL880VTI	5,5 x 85	T30	10	75	600	157,37
97183	TGXA108100	8x100	GXL8100VTI	5,5x105	T30	30	50	400	163,62
97184	TGXA108120	8x120	GXL8120VTI	5,5x125	T30	50	50	400	170,52
97016	TGXA10080	10x80	GXL1080VTI	7x85	T40	10	50	400	246,00
97017	TGXA10100	10x100	GXL10100VTI	7x105	T40	30	40	320	281,72
97018	TGXA10120	10x120	GXL10120VTI	7x125	T40	50	50	400	344,18
97019	TGXA10140	10x140	GXL10140VTI	7x145	T40	70	25	200	381,65
97020	TGXA10160	10x160	GXL10160VTI	7x165	T40	90	25	200	435,66
97021	-	10x200	GXL10200VTI	7x205	T40	130	25	150	810,00

Taco GX-L / VE

Con **TORNILLO HEXAGONAL**
Homologación CE



P.196



ETAG 020
ETA 12-0261



GX-L
Ø10mm

on line



professional design
of anchorage in concrete
PROGRAMA DE CÁLCULO



SOLICITAR
HOMOLOGACIÓN

POLIAMIDA 6.6 - ZINCADO

CÓDIGO CODE	MRF	MEDIDA SIZE	DESCR.			MAX.			€/ 100
97126	TGXH08080	8x80	GXL880VE	5,5 x 85	10	10	75	600	56,52
97127	TGXH08100	8x100	GXL8100VE	5,5x105	10	30	50	400	66,98
97128	TGXH08120	8x120	GXL8120VE	5,5x125	10	50	50	400	80,25
97022	TGXH10080	10x80	GXL1080VE	7x85	13	10	50	400	79,68
97023	TGXH10100	10x100	GXL10100VE	7x105	13	30	50	400	105,08
97024	TGXH10120	10x120	GXL10120VE	7x125	13	50	50	400	124,34
97025	TGXH10140	10x140	GXL10140VE	7x145	13	70	25	200	140,26
97026	TGXH10160	10x160	GXL10160VE	7x165	13	90	25	200	154,60
97027	TGXH10200	10x200	GXL10200VE	7x205	13	130	25	150	256,26
97028	TGXH10240	10x240	GXL10240VE	7x245	13	170	20	120	280,32
97029	TGXH10260	10x260	GXL10260VE	7x265	13	190	20	120	309,65

Taco GX-L / VEI

Con **TORNILLO HEXAGONAL**
INOX A4 (AISI 316)
Homologación CE



POLIAMIDA 6.6 - INOX A4

CÓDIGO CODE	MRF	MEDIDA SIZE	DESCR.			MAX.			€/ 100
97118	TGXHI10080	10x80	GXL1080VEI	7x85	13	10	50	400	274,86
97119	TGXHI10100	10x100	GXL10100VEI	7x105	13	30	50	400	392,12
97120	TGXHI10120	10x120	GXL10120VEI	7x125	13	50	50	400	406,88



ETAG 020
ETA 12-0261



GX-L
Ø 10mm

on line



professional design
of anchorage in concrete
PROGRAMA DE CÁLCULO

GX-L NYLON

DISEÑO G&B



piedra stone hormigón concrete hormigón hueco concrete hollow ladrillo macizo solid brick semimacizo semi-solid brick ladrillo hueco hollow brick

Taco GX-L / VEFT

Con **TORNILLO CABEZA HEXAGONAL / TX40**, con arandela prensada Ø17,7 Homologación CE

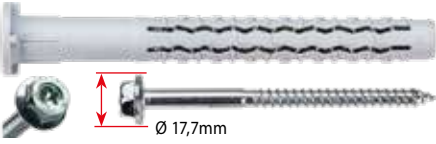

on line
G&B CALCULATION PROGRAM 4.3
 professional design of anchorage in concrete
 PROGRAMA DE CÁLCULO



POLIAMIDA 6.6 - ZINCADO

CÓDIGO CODE	MEDIDA SIZE	DESCR.			MAX.			€/100
97030	10x80	GXL1080VEFT	7x85	13	10	50	400	85,23
97031	10x100	GXL10100VEFT	7x105	13	30	50	400	98,36
97032	10x120	GXL10120VEFT	7x125	13	50	25	200	118,36
97033	10x140	GXL10140VEFT	7x145	13	70	25	200	147,69
97034	10x160	GXL10160VEFT	7x165	13	90	25	200	170,76

Taco GX-L / VEFTI

Con **TORNILLO CABEZA HEXAGONAL/TX40**, con arandela prensada Ø17,7 **INOX A4 (AISI 316)** Homologación CE

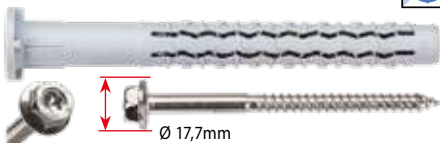

POLIAMIDA 6.6 - INOX A4

CÓDIGO CODE	MEDIDA SIZE	DESCR.			MAX.			€/100
97214	10x80	GXL1080VEFTI	7x85	13	10	50	400	322,73
97215	10x100	GXL10100VEFTI	7x105	13	30	50	400	375,02
97216	10x120	GXL10120VEFTI	7x125	13	50	25	200	431,18

Taco GX-L / VTF

Con **TORNILLO DE CABEZA GRANDE**, huella TX30, fijaciones especiales para ventanas y cerramientos



POLIAMIDA 6.6 - ZINCADO

CÓDIGO CODE	MEDIDA SIZE	DESCR.			MAX.			€/100
97220	8x80	GXL880VTF	6x80	T30	10	75	600	68,23
97221	8x100	GXL8100VTF	6x100	T30	30	50	400	80,60



Taco GX-L / VA

Con **TORNILLO INVIOLEABLE TX40**, con estrella, zincado blanco



POLIAMIDA 6.6 - ZINCADO

CÓDIGO CODE	MEDIDA SIZE	DESCR.			MAX.			€/100
97089	10x80	GXL1080VA	7x85	T40	10	50	400	107,62
97090	10x100	GXL10100VA	7x105	T40	30	50	400	123,78
97091	10x120	GXL10120VA	7x125	T40	50	50	400	148,90
97092	10x140	GXL10140VA	7x145	T40	70	25	200	177,16
97093	10x160	GXL10160VA	7x165	T40	90	25	200	185,43

Taco GX-L

Taco de nylon **LARGO**, cuatro expansiones, POLIAMIDA 6.6



POLIAMIDA 6.6

CÓDIGO CODE	MEDIDA SIZE			€/100
TNYLGXL880	8 x 80	50	600	16,13
TNYLGXL810	8 x 100	50	600	16,68
TNYLGXL812	8 x 120	50	600	17,34
TNYLGXL814	8 x 140	50	600	18,72
TNYLGXL108	10 x 80	50	600	20,26
TNYLGXL100	10 x 100	50	300	23,98
TNYLGXL120	10 x 120	50	300	25,90
TNYLGXL140	10 x 140	50	300	28,05
TNYLGXL160	10 x 160	50	200	29,61
TNYLGXLS200	10 x 200	50	150	49,02
TNYLGXLS240	10 x 240	50	150	51,88

CONDOR CORNICE NYLON



Taco CONDOR CORNICE / V

Con TORNILLO AVELLANADO huella TX



POLIAMIDA 6.6 - ZINCADO

	CÓDIGO CODE	MEDIDA SIZE	DESCR.			MAX.			€/ 100
NEW	HTV01	6x60	C6A60V	4x70	T30	30	150	1.200	24,32
	HTV015	8x60	C8A60V	5,5x65	T30	20	100	800	38,72
NEW	HTV02	8x80	C8A80V	5,5x85	T40	40	100	800	53,23
	HTV03	8x100	C8A100V	5,5x105	T30	60	50	400	74,99
	HTV04	8x120	C8A120V	5,5x125	T30	80	50	400	82,99
	HTV06	10x65	C10A65V	7x70	T40	20	50	400	68,16
	HTV07	10x80	C10A80V	7x85	T40	35	50	400	80,16
	HTV08	10x100	C10A100V	7x105	T40	55	40	320	92,75
	HTV09	10x115	C10A115V	7x125	T40	70	50	400	121,23
	HTV10	10x135	C10A135V	7x145	T40	90	25	200	141,65
	HTV11	10x160	C10A160V	7x165	T40	115	25	200	164,32

Taco CONDOR CORNICE / VE

TORNILLO HEXAGONAL



POLIAMIDA 6.6 - ZINCADO

	CÓDIGO CODE	MEDIDA SIZE	DESCR.			MAX.			€/ 100
	*HTVE015	8x60	C8A60VE	5,5x65	10	20	100	800	41,95
	*HTVE02	8x80	C8A80VE	5,5x85	10	40	75	600	60,45
	*HTVE03	8x100	C8A100VE	5,5x105	10	60	50	400	62,25
	*HTVE04	8x120	C8A120VE	5,5x125	10	80	50	400	80,98
	*HTVE07	10x80	C10A80VE	7x85	13	35	50	400	79,78
	*HTVE08	10x100	C10A100VE	7x105	13	55	50	400	99,78
	*HTVE09	10x115	C10A115VE	7x125	13	70	50	400	117,49
	*HTVE10	10x135	C10A135VE	7x145	13	90	25	200	138,69
	*HTVE11	10x160	C10A160VE	7x165	13	115	25	200	154,29

(*) HASTA FINAL DE EXISTENCIAS

LATER CORNICE NYLON



Taco LATER CORNICE / Ø8

Diámetro 8



POLIAMIDA 6.6 - ZINCADO

	CÓDIGO CODE	MEDIDA SIZE	DESCR.		MAX.			€/ 100
	19060	8x80	C8A80LU	-	-	100	800	32,33
	19061	8x100	C8A100LU	-	-	100	800	36,06
	19062	8x120	C8A120LU	-	-	100	800	43,81
	19063	8x140	C8A140LU	-	-	100	800	41,44

Taco LATER CORNICE / Ø10 - Ø12

Diámetro 10



Diámetro 12



POLIAMIDA 6.6 - ZINCADO

	CÓDIGO CODE	MEDIDA SIZE	DESCR.		MAX.			€/ 100
	19005	10x80	C10A80LU	-	-	100	800	16,56
	19001	10x100	C10A100LU	-	-	100	800	23,51
	19002	10x120	C10A120LU	-	-	100	800	24,77
	19003	10x140	C10A140LU	-	-	50	400	30,99
	19004	10x160	C10A160LU	-	-	50	400	32,87
	HTLA1216	12x160	C12A160LU	-	-	-	400	68,05

Taco LATER CORNICE / LUVT Ø8

Con TORNILLO AVELLANADO huella TX30



POLIAMIDA 6.6 - ZINCADO

	CÓDIGO CODE	MEDIDA SIZE	DESCR.			MAX.			€/ 100
	HTLAUT11	8x60	C8A60LUVT	5,5x65	T30	5	100	800	50,03
	HTLAUT01	8x80	C8A80LUVT	5,5x85	T30	35	50	400	72,91
	HTLAUT02	8x100	C8A100LUVT	5,5x105	T30	55	50	400	86,24
	HTLAUT03	8x120	C8A120LUVT	5,5x125	T30	75	50	400	98,77
	HTLAUT07	8x140	C8A140LUVT	5,5x145	T30	95	50	400	119,47

LATER CORNICE NYLON



semimacizo
semi-solid brick

ladrillo hueco
hollow brick



SOLICITAR
FICHA TÉCNICA

Taco LATER CORNICE / LUVT Ø10

Con TORNILLO AVELLANADO TX40



POLIAMIDA 6.6 - ZINCADO

CÓDIGO CODE	MEDIDA SIZE	DESCR.			↓ MAX.			€/100
HTLAUT10	10x80	C10A80LUVT	7x85	T40	5	50	400	60,24
HTLAUT08	10x100	C10A100LUVT	7x105	T40	25	40	320	70,97
HTLAUT04	10x120	C10A120LUVT	7x125	T40	45	50	400	86,44
HTLAUT05	10x140	C10A140LUVT	7x145	T40	65	25	200	109,57
HTLAUT06	10x160	C10A160LUVT	7x165	T40	85	25	200	127,57
HTLAUT09	10x200	C10A200LUVT	7x205	T40	125	25	150	180,77

Taco LATER CORNICE / LUVE Ø10

Con TORNILLO HEXAGONAL



POLIAMIDA 6.6 - ZINCADO

CÓDIGO CODE	MEDIDA SIZE	DESCR.			↓ MAX.			€/100
HTLAUE10	10x80	C10A80LUVE	7x85	13	5	50	400	68,91
HTLAUE08	10x100	C10A100LUVE	7x105	13	25	50	400	88,11
HTLAUE04	10x120	C10A120LUVE	7x125	13	45	50	400	106,91
HTLAUE05	10x140	C10A140LUVE	7x145	13	65	25	200	118,60
HTLAUE06	10x160	C10A160LUVE	7x165	13	85	25	200	133,55
HTLAUE09	10x200	C10A200LUVE	7x205	13	125	25	150	217,59

Taco LATER CORNICE / LUVE Ø12

Con TORNILLO HEXAGONAL



POLIAMIDA 6.6 - ZINCADO

CÓDIGO CODE	MEDIDA SIZE	DESCR.			↓ MAX.			€/100
HTLAUE11	12x160	C12A160LUVE	10x160	17	60	25	225	198,61
HTLAUE12	12x200	C12A200LUVE	10x200	17	100	20	180	246,95
HTLAUE13	12x240	C12A240LUVE	10x240	17	140	20	120	351,49

Taco LATER CORNICE / LUVEFL Ø16

Con TORNILLO HEXAGONAL y arandela estampada



POLIAMIDA 6.6 - ZINCADO

CÓDIGO CODE	MEDIDA SIZE	DESCR.			↓ MAX.			€/100
37093	16x140	C16A140LUVEFL	12x150	19	20	10	80	299,79
37094	16x160	C16A160LUVEFL	12x170	19	40	10	80	339,04
37095	16x200	C16A200LUVEFL	12x210	19	80	10	60	367,41
37096	16x240	C16A240LUVEFL	12x250	19	120	10	60	442,19

TURBO JET NYLON



pedra stone
hormigón concrete
ladrillo macizo solid brick



CERTIFICADO CE PARA APLICACIONES EN HORMIGÓN / PIEDRA Y ALBAÑILERÍA COMPLETA

Taco TURBO JET / SV CABEZA AVELLANADA, premontado



EAD 330196-01-0604
base material: a,b
Ø5, Ø6, Ø8

on line
G&B CALCULATION PROGRAM 4.3
professional design of anchorage in concrete
PROGRAMA DE CÁLCULO



ETA
SOLICITAR HOMOLOGACIÓN

POLIAMIDA 6.6 - ZINCADO

CÓDIGO CODE	MEDIDA SIZE	DESCR.		MAX.			€/ 100
93025	5x27	TJ5-27SV	3,5x32	5	100	3.200	7,09
93026	5x37	TJ5-37SV	3,5x42	15	100	3.200	8,20
93027	5x47	TJ5-47SV	3,5x52	25	100	1.600	9,99
93028	6x32	TJ6-32SV	3,8x37	5	100	1.600	9,29
93029	6x40	TJ6-40SV	3,8x45	10	100	1.600	10,72
93030	6x55	TJ6-55SV	3,8x60	25	100	1.600	12,22
93031	6x67	TJ6-67SV	3,8x72	37	100	800	14,66
93032	6x80	TJ6-80SV	3,8x85	50	100	800	17,45
93033	8x45	TJ8-45SV	4,8x50	10	100	800	18,14
93034	8x60	TJ8-60SV	4,8x65	25	100	800	19,58
93035	8x75	TJ8-75SV	4,8x80	40	100	800	26,43
93036	8x100	TJ8-100SV	4,8x105	65	50	400	34,54
93037	8x120	TJ8-120SV	4,8x125	85	50	400	39,46
93038	8x135	TJ8-135SV	4,8x140	100	50	400	46,06

Taco TURBO JET / SV En BOTE DE PLÁSTICO transparente reutilizable EASY BOX



POLIAMIDA 6.6 - ZINCADO

CÓDIGO CODE	MEDIDA SIZE	DESCR.		MAX.			€/ 1
93260	5x27	TJ5-27SV	3,5x32	5	800	6	69,06
93261	6x40	TJ6-40SV	3,8x45	10	400	6	56,56

Taco TURBO JET / SVI CABEZA AVELLANADA, premontado INOX A2 (AISI 304)



EAD 330196-01-0604
base material: a,b
Ø5, Ø6, Ø8

on line
G&B CALCULATION PROGRAM 4.3
professional design of anchorage in concrete
PROGRAMA DE CÁLCULO



ETA
SOLICITAR HOMOLOGACIÓN

POLIAMIDA 6.6

CÓDIGO CODE	MEDIDA SIZE	DESCR.		MAX.			€/ 100
HTTSI21	5x27	TJ5-27SVI	3,5x32	5	100	3.200	29,25
HTTSI22	5x50	TJ5-50SVI	3,5x55	25	100	1.600	37,50
HTTSI23	6x40	TJ6-40SVI	3,8x45	10	100	1.600	52,65
HTTSI24	6x67	TJ6-67SVI	3,8x72	30	100	1.600	64,77
HTTSI30	6x80	TJ6-80SVI	3,8x85	50	50	800	96,75
HTTSI25	8x60	TJ8-60SVI	4,8x65	20	100	800	124,65
HTTSI26	8x75	TJ8-75SVI	4,8x80	40	100	800	157,80
HTTSI27	8x100	TJ8-100SVI	4,8x105	60	50	400	200,93
HTTSI28	8x120	TJ8-120SVI	4,8x125	80	50	400	241,51

Taco TURBO JET / V CABEZA CILÍNDRICA, premontado



EAD 330196-01-0604
base material: a,b
Ø5, Ø6, Ø8

on line
G&B CALCULATION PROGRAM 4.3
professional design of anchorage in concrete
PROGRAMA DE CÁLCULO



ETA
SOLICITAR HOMOLOGACIÓN

POLIAMIDA 6.6 - ZINCADO

CÓDIGO CODE	MEDIDA SIZE	DESCR.		MAX.			€/ 100
93011	5x27	TJ5-27V	3,5x32	5	100	3.200	7,09
93012	5x37	TJ5-37V	3,5x42	15	100	3.200	8,20
93013	5x47	TJ5-47V	3,5x52	25	100	1.600	9,99
93014	6x32	TJ6-32V	3,8x37	5	100	1.600	9,29
93015	6x40	TJ6-40V	3,8x45	10	100	1.600	10,72
93016	6x55	TJ6-55V	3,8x60	25	100	1.600	12,22
93017	6x67	TJ6-67V	3,8x72	37	100	800	14,66
93018	6x80	TJ6-80V	3,8x85	50	50	800	17,45
93019	8x45	TJ8-45V	4,8x50	10	100	800	18,14
93020	8x60	TJ8-60V	4,8x65	25	100	800	19,58
93021	8x75	TJ8-75V	4,8x80	40	100	800	29,28
93022	8x100	TJ8-100V	4,8x105	65	50	400	34,54
93023	8x120	TJ8-120V	4,8x125	85	50	400	39,46
93024	8x135	TJ8-135V	4,8x140	100	50	400	46,06

TURBO JET NYLON



pedra stone hormigón concrete ladrillo macizo solid brick

Taco TURBO / SV Ø10

CABEZA AVELLANADA, RAL 7035, premontado



POLIAMIDA 6.6 - ZINCADO

CÓDIGO CODE	MEDIDA SIZE	DESCR.		↓ MAX.			€/ 100
41242	10x100	T10-100SV	6x105	50	50	400	99,67
41243	10x120	T10-120SV	6x125	70	50	400	107,73
41244	10x140	T10-140SV	6x145	90	25	200	139,67
41245	10x160	T10-160SV	6x165	110	25	150	159,67

Taco TURBO JET / B

CABEZA ANCHA, color gris RAL 7035, premontado



EAD 330196-01-0604
base material: a,b
Ø5, Ø6, Ø8



on line
professional design
of anchorage in concrete
PROGRAMA DE CÁLCULO



ETA
SOLICITAR
HOMOLOGACIÓN

POLIAMIDA 6.6 - ZINCADO

CÓDIGO CODE	MEDIDA SIZE	DESCR.		↓ MAX.			€/ 100
93001	5x27	TJ5-27B	3,5x32	5	100	3.200	7,09
93002	5x37	TJ5-37B	3,5x42	15	100	3.200	8,20
93003	6x32	TJ6-32B	3,8x37	5	100	1.600	9,29
93004	6x40	TJ6-40B	3,8x45	10	100	1.600	10,72
93005	6x55	TJ6-55B	3,8x60	25	50	800	12,22
93006	8x45	TJ8-45B	4,8x50	10	100	800	18,14
93007	8x60	TJ8-60B	4,8x60	25	100	800	19,58

Taco TURBO JET / B

En BOTE DE PLÁSTICO transparente reutilizable EASY BOX



POLIAMIDA 6.6 - ZINCADO

CÓDIGO CODE	MRF	DESCR.		↓ MAX.		€/ 1
93250	TNGE527BP	TJ5-27B	3,5x32	5	750	59,25
93251	TNGE632BP	TJ6-32B	3,8x37	5	500	52,59
93252	TNGE640BP	TJ6-40B	3,8x45	10	500	59,72

Taco TURBO JET Nylon

Color marrón oscuro,
con tornillo TPS zincado negro



PREMONTADO

NEW

CÓDIGO CODE	MEDIDA SIZE	DESCR.		↓ MAX.			€/ 100
93008	6x32	TJ6-32BM	3,8x40	5	100	1.600	19,33
93009	6x40	TJ6-40BM	3,8x50	13	100	1.600	28,53
93010	6x55	TJ6-55BM	3,8x60	28	100	800	38,00

Taco TURBO JET Nylon

Color marrón oscuro,
con tornillo TPS color cobre



PREMONTADO

NEW

CÓDIGO CODE	MEDIDA SIZE	DESCR.		↓ MAX.			€/ 100
93039	6x32	TJ6-32BR	3,8x40	5	100	1.600	37,33
93040	6x40	TJ6-40BR	3,8x50	10	100	1.600	82,87
93041	6x55	TJ6-55BR	3,8x60	25	100	800	100,00

Taco TURBO JET Nylon

Con tornillo M6



PREMONTADO

NEW

CÓDIGO CODE	MEDIDA SIZE	DESCR.		↓ MAX.			€/ 100
93042	6x40	TJ6-40VF	4x45	-	100	1.600	24,87



EAD 330196-01-0604
base material: a,b
Ø5, Ø6, Ø8



on line
professional design
of anchorage in concrete
PROGRAMA DE CÁLCULO

ISOFIS

Para la fijación de paneles aislantes

Taco ISOFIS ISA8

CLAVO DE ACERO, cabeza Ø60.
Homologación CE



on line
G&B CALCULATION PROGRAM 12
professional design
of anchorage in concrete
PROGRAMA DE CÁLCULO



POLIETILENO

CÓDIGO CODE	MEDIDA SIZE	DESCR.	↓ MAX.	↓ MAX.*		€/ 100
HIA8095	8x95	ISA895	70	30	200	60,27
HIA8115	8x115	ISA8115	90	50	200	76,40
HIA8135	8x135	ISA8135	110	70	200	85,67
HIA8155	8x155	ISA8155	130	90	200	90,00
HIA8175	8x175	ISA8175	150	110	200	104,53
HIA8195	8x195	ISA8195	170	130	200	112,53

* Solo para hormigón celular

Taco ISOFIS IS8 e IS10

CLAVO DE POLIAMIDA, cabeza Ø60.
Homologación CE



on line
G&B CALCULATION PROGRAM 12
professional design
of anchorage in concrete
PROGRAMA DE CÁLCULO



POLIETILENO

CÓDIGO CODE	MEDIDA SIZE	DESCR.	↓ MAX.	↓ MAX.*		€/ 100
HI8095	8x95	IS895	70	30	200	30,67
HI8115	8x115	IS8115	90	50	200	34,24
HI8135	8x135	IS8135	110	70	200	37,38
HI8155	8x155	IS8155	130	90	200	41,73
HI8175	8x175	IS8175	150	110	200	44,51
HI8195	8x195	IS8195	170	130	200	47,67
HI1070	10x70	IS10/70	40	20	200	26,82
HI1090	10x90	IS10/90	60	40	200	29,32
HI10110	10x110	IS10/110	80	60	200	31,53
HI10140	10x140	IS10/140	110	90	200	38,00
HI10160	10x160	IS10/160	130	110	200	42,51
HI10180	10x180	IS10/180	150	130	200	46,00
HI10200	10x200	IS10/200	170	150	200	54,28
HI10220	10x220	IS10/220	190	170	100	58,85
HI10260	10x260	IS10/260	230	210	100	68,69

* Solo para hormigón celular

Taco ISOFIS AIS

CLAVO DE POLIPROPILENO, cabeza Ø50



POLIPROPILENO

CÓDIGO CODE	MEDIDA SIZE	↓ MAX.		€/ 100
FAC10070	10x70	20 - 45	250	20,14
FAC10090	10x90	40 - 65	250	20,83
FAC10110	10x110	70 - 95	250	24,51
FAC10130	10x130	90 - 110	250	30,33
FAC10150	10x150	115 - 130	250	41,63
FAC10180	10x180	130 - 155	250	50,54



GALVANIZADO

CÓDIGO CODE	MEDIDA SIZE	DESCR.	↓ MAX.			€/ 100
HA8090	8x90	IA890	50	50	500	28,60
HA8110	8x110	IA8110	70	50	500	29,78
HA8140	8x140	IA8140	100	50	500	38,45
HA8170	8x170	IA8170	130	50	350	42,35
HA8200	8x200	IA8200	160	50	350	51,70
HA8250	8x250	IA8250	210	50	250	54,45
HA8300	8x300	IA8300	260	50	250	66,00

Taco de acero ISOFIS / IA

CLAVO DE ACERO, cabeza Ø35.
CERTIFICADO CE



Conforme a EN14566: 2008 + A1: 2009
Reacción al fuego : A1

POLIPROPILENO

CÓDIGO CODE	Ø CABEZA Ø HEAD	DESCR.	↓ MAX.			€/ 100
64065	60	RHI06	5-6	100	400	25,00

Arandela ISOFIS con tapa

ARANDELA DE POLIPROPILENO, cabeza Ø 60 mm



GB NYLON

Taco ISORAPID para SATE

Para la fijación de cargas ligeras a los paneles de poliuretano y poliestireno. Evita los puentes térmicos.



poliestireno
polystyrene

POLIAMIDA 6.6

CÓDIGO CODE	MEDIDA SIZE	DESCR.		CABEZA HEAD			€/ 100
64066	25x58	TPI60	4,5-5	T40	50	400	133,75
64067	32x97	TPI95	M8-M10	TE13	25	150	271,80



hormigón ligero
aerated concrete

Taco GB para GASBETON

Instalación con llave Allen 4-6-8-10



POLIAMIDA 6.6

CÓDIGO CODE	MEDIDA SIZE	DESCR.				€/ 100
* HGSB04	10x60	GB4	4,0-4,5/M4	50	800	26,07
* HGSB06	10x60	GB6	5,0-6,0/M5	50	800	31,13
* HGSB08	12x70	GB8	7,0-8,0/M8	50	400	36,00
* HGSB10	14x80	GB10	9,0-10,0/M10	50	300	43,33

(*) HASTA FINAL DE EXISTENCIAS

SANI-FIS

FIJACIONES PARA SANITARIOS



piedra
stone

hormigón
concrete

ladrillo macizo
solid brick

semimacizo
semisolid brick

SANIFIS SF2

INOX A2 (AISI 304)

Kit FIJACIÓN DE SANITARIOS al suelo, con tuerca ciega M6 (llave 10)

INOX (A2)



CÓDIGO CODE	MEDIDA SIZE	DESCR.	VARILLA ROD	Nº PIEZAS KIT		€/ KIT
HSF02	8x40	SF2	M6x80	2	50	7,00

SANIFIS SF3

Kit FIJACIÓN DE SANITARIOS a paredes



CÓDIGO CODE	MEDIDA SIZE	DESCR.	VARILLA ROD	Nº PIEZAS KIT		€/ KIT
HSF310	10x50	SF3/100	8x100	2	25	3,41
HSF320	12x60	SF3/120	10x120	2	25	4,73
HSF340	14x70	SF3/140	10x140	2	25	5,00

SANIFIS SF5

Kit FIJACIÓN PARA LAVABO con tuerca de acero taco GL Nylon



CÓDIGO CODE	MEDIDA SIZE	DESCR.	VARILLA ROD	Nº PIEZAS KIT		€/ KIT
HSF510	10x50	SF5/100	8x100	2	25	2,07
HSF520	12x60	SF5/120	10x120	2	25	4,53
HSF540	14x70	SF5/140	10x140	2	25	5,80

SANIFIS SF4

Kit FIJACIÓN DE CALENTADORES DE AGUA, taco GL Nylon + Alcayata



CÓDIGO CODE	MEDIDA SIZE	DESCR.	VARILLA ROD	Nº PIEZAS KIT		€/ KIT
HSF410	10x50	SF4/10	8x65	1	50	1,50
HSF412	12x60	SF4/12	10x75	1	50	2,80
HSF414	14x70	SF4/14	10x95	1	25	3,33

BCM NYLON



Taco BCM



POLIAMIDA 6.6

CÓDIGO CODE	MEDIDA SIZE	DESCR.		MAX.			€/ 100
* HBM08	12x72	BCM8	-	-	50	400	70,00
* HBM10	14x72	BCM10	-	-	50	400	78,87

(*) HASTA FINAL DE EXISTENCIAS

Taco BCM / V

Con Tornillo



POLIAMIDA 6.6

CÓDIGO CODE	MEDIDA SIZE	DESCR.		MAX.			€/ 100
* HBV08	12x72	BCM8/V	M-8x80	10	50	400	170,49
* HBV10	14x72	BCM10/V	M-10x80	8	25	200	224,67

(*) HASTA FINAL DE EXISTENCIAS

Taco BCM / SA

Completo con accesorios para la fijación de los sanitarios y calentadores de agua



POLIAMIDA 6.6

CÓDIGO CODE	MEDIDA SIZE	DESCR.	VARILLA ROD	Nº PIEZAS KIT		€/ KIT
* HBT01	14x72	BCM10/120	10x130	2	25	6,47

(*) HASTA FINAL DE EXISTENCIAS

Taco BCM / GR

Con Gancho Recto



POLIAMIDA 6.6

CÓDIGO CODE	MEDIDA SIZE	DESCR.	VARILLA ROD	Nº PIEZAS KIT		€/ KIT
* HBG01	14x72	BCM10/414	10x95	2	50	4,60

(*) HASTA FINAL DE EXISTENCIAS



MA MULTIANCHOR RESINA POLIÉSTER

CE OPTION 7

Certificado CE-7

Para aplicaciones con varillas roscadas sobre hormigón no fisurado



on line

G&B CALCULATION PROGRAM 4.3

professional design of anchorage in concrete
PROGRAMA DE CÁLCULO



(300ml)

Formato 410-300ml disponible color beige



CÓDIGO CODE	DESCR.	CONT.	MEZCLADOR MIXER	DURACIÓN MESES		€/1	PARA PISTOLA FOR GUN
→ CC17	MA175	175	1 M17	18	12	16,55	SK2
→ CC30	MA300	300	1 M17	18	12	11,91	SK2-PK17
CC40	MA410	410	1 M17	18	12	16,13	PK1-PK11-PK30-PK16
→ CC30P	MA300 ●	300	1 M17	18	12	15,33	SK2-PK17
CC40P	MA410 ●	410	1 M17	18	12	21,43	PK1-PK11-PK30-PK16

→ MAYOR TIEMPO DE CADUCIDAD

SH-PRO SUPER HYBRID FORMULACIÓN HÍBRIDA SIN ESTIRENO

Libre de aditivos y disolventes. Nocivo para el medio ambiente y el operador

Certificado CE-7

Para hormigón no fisurado y mampostería de ladrillo macizo y perforado

Homologado MADERA-MADERA

Para instalación de marcos de ventanas



on line

G&B CALCULATION PROGRAM 4.3

professional design of anchorage in concrete
PROGRAMA DE CÁLCULO



(300ml)

Formato 410-300ml disponible color beige



CÓDIGO CODE	DESCR.	CONT.	MEZCLADOR MIXER	DURACIÓN MESES		€/1	PARA PISTOLA FOR GUN
→ CC02	SHPRO300	300	1 M17	18	12	14,25	SK2-PK17
CC01	SHPRO410	410	1 M17	18	12	17,86	PK1-PK11-PK30-PK16
→ CC02P	SHPRO300 ●	300	1 M17	18	12	18,23	SK2-PK17
CC01P	SHPRO410 ●	410	1 M17	18	12	23,51	PK1-PK11-PK30-PK16
NEW KITSH3	SHPRO300	300	-	18	12	34,52	SK2-PK17

→ MAYOR TIEMPO DE CADUCIDAD

GEBOFIX XTR EXTREME HYBRID CE1
RESINA VINILÉSTER HÍBRIDA
SIN ESTIRENO

CE OPTION 1

Certificado CE opción 1

Para aplicaciones con varillas roscadas y corrugadas sobre hormigón fisurado y no fisurado.
Certificado para fijaciones en áreas sísmicas.
Certificado CE para mampostería maciza y hueca.



on line



professional design of anchorage in concrete
PROGRAMA DE CÁLCULO

CE EAD 330499-01-0601 OPTION 1
22 2873
ETA 22/0214
M8-M24/08-025
SEISMIC Cat. C1 M8-M16
SEISMIC Cat. C2 M12-M16

CE EAD 330076-01-0604 Use Category b, c, d, d/d, w/w
22 2873
ETA 22/0211
M8-M16

CE EAD 330087-01-0601
22 2873
ETA 22/0213
08-025

EMISSIONS DANS L'AIR INTÉRIEUR **A+**

LEED® According to LEED® IEQ 4.1

PARA USO EN CONTACTO CON AGUA POTABLE

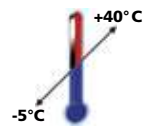

CÓDIGO CODE	DESCR.	CONT.	MEZCLADOR MIXER	DURACIÓN MESES		€/1	PARA PISTOLA FOR GUN
CC38	XTR300	300	1 M17	12	12	22,01	SK2 - PK17
CC37	XTR410	410	1 M17	18	12	28,26	PK1-PK11-PK30-PK16

PRO-SISMIK VE-SF CE1
RESINA VINILÉSTER
SIN ESTIRENO

CE OPTION 1

Certificado CE opción 1

Para aplicaciones con varillas roscadas y corrugadas sobre hormigón fisurado y no fisurado.
Certificado para fijaciones en áreas sísmicas.
Certificado CE para mampostería maciza y hueca.



on line



professional design of anchorage in concrete
PROGRAMA DE CÁLCULO

CE EAD 330499-01-0601 OPTION 1
13 1020
ETA 19/0699
M8-M30/08-032
SEISMIC Cat. C1 M10-M24
SEISMIC Cat. C2 M12-M20

CE EAD 330076-00-0604 Use Category b,c,w/d
13 1020
ETA 16/0919
M8-M12

CE ETAG 001-5 TR23
10 1020
ETA 16/0599
08-032

EMISSIONS DANS L'AIR INTÉRIEUR **A+**

LEED® According to LEED® IEQ 4.1

PARA USO EN CONTACTO CON AGUA POTABLE

ALTAS PRESTACIONES SOBRE HORMIGÓN FISURADO Y EN APLICACIONES EN ZONA SÍSMICA

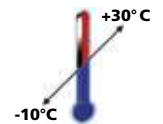

CÓDIGO CODE	DESCR.	CONT.	MEZCLADOR MIXER	DURACIÓN MESES		€/1	PARA PISTOLA FOR GUN
CC32	PRO T300VE-SF	300	1 M17	18	12	21,79	SK2-PK17
CC14	PRO T345VE-SF	350	2 M17	18	12	35,94	PK5
CC13	PRO T410VE-SF	410	2 M17	18	12	28,44	PK1-PK11-PK30-PK16

**PRO SISMIK NORDIC VE-SK
RESINA VINILÉSTER
SIN ESTIRENO**

CE OPTION 1

FORMULACIÓN DE INVIERNO. APLICACIONES HASTA -20° C.

Certificado CE-1

Para aplicaciones con varillas roscadas y corrugadas sobre hormigón fisurado y no fisurado



on line



professional design of anchorage in concrete
PROGRAMA DE CÁLCULO



CCWT13
410ml



CCWT32
300ml



M17



CÓDIGO CODE	DESCR.	CONT.	MEZCLADOR MIXER	DURACIÓN MESES		€/1	PARA PISTOLA FOR GUN
CCWT32	T300V NORDIC	300	1 M17	18	12	27,95	SK2-PK17
CCWT13	T410V NORDIC	410	1 M17	18	12	37,17	PK1-PK11-PK30-PK16

**GEBOFIX EPO PLUS RE
RESINA EPOXÍDICA PURA 3:1
CERTIFICADO CE-1**

CE OPTION 1

Proporción de mezcla 3:1

Certificado CE-1

Para aplicaciones con varillas roscadas y corrugadas sobre hormigón fisurado y no fisurado

Certificado para FIJACIONES EN ZONAS SÍSMICAS



on line



professional design of anchorage in concrete
PROGRAMA DE CÁLCULO

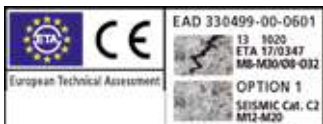

CCPE585
585ml



CCPE385
385ml



CME12



CÓDIGO CODE	DESCR.	CONT.	MEZCLADOR MIXER	DURACIÓN MESES		€/1	PARA PISTOLA FOR GUN
CCPE385	EPO PLUS RE T385	385	1 CME12	24	12	49,79	CP18-CP19
CCPE585	EPO PLUS RE T585	585	1 CME12	24	12	67,84	CP19

KIT CAJA MA MULTIANCHOR CE7 RESINA POLIÉSTER



Certificado CE-7
Para aplicaciones con varillas roscadas
sobre hormigón no fisurado



G&B FISSAGGI PLANT 4
MA Multi Anchor
DoP : DPGEBT036



CCVAL40
410ml



CCVAL30
300ml

CÓDIGO CODE	DESCR.	CONT.	DURACIÓN MESES DURATION MONTHS		€/1
CCVAL30	KIT CAJA MA300	30 CC30 30 cánulas M17	18	1	559,00
CCVAL40	KIT CAJA MA410	20 CC40 20 cánulas M17	18	1	510,78

KIT CAJA PRO-SISMİK VE-SF CE1 RESINA VINILÉSTER SIN ESTIRENO



CE OPTION 1

Para aplicaciones con varillas roscadas y corrugadas
sobre hormigón fisurado y no fisurado

Certificado para FIJACIONES EN ZONAS SÍSMICAS

**ALTAS PRESTACIONES
SOBRE HORMIGÓN FISURADO
Y EN APLICACIONES
EN ZONA SÍSMICA**



CCVAL13
410ml



CCVAL32
300ml

CÓDIGO CODE	DESCR.	CONT.	DURACIÓN MESES DURATION MONTHS		€/1
CCVAL32	KIT CAJA PRO T300 VE-SF	30 CC32 30 cánulas M17	18	1	930,45
CCVAL13	KIT CAJA PRO T410 VE-SF	20 CC13 20 cánulas M17	18	1	818,58



CÁPSULA QUÍMICA GEBOFIX TF

Homologación CE- Opción 7



on line
G&B CALCULATION PROGRAM 4.3
professional design of anchorage in concrete
PROGRAMA DE CÁLCULO



CÓDIGO CODE	MEDIDA Øx L	DESCR.		DURACIÓN MESES			€/ 100
C08	10x80	TF08	M8	18	10	200	297,67
C10	12x90	TF10	M10	18	10	200	305,22
C12	14x110	TF12	M12	18	10	200	350,65
C16	18x125	TF16	M16	18	10	200	385,59
C20	25x170	TF20	M20	18	5	50	833,96
C24*	28x210	TF24	M24	18	6	50	1.031,68

* Disponible bajo pedido / * Available on request

ESPÁRRAGO ROSCADO / BF

Con corte 45°

Acero, clase 5.8, extremo hexagonal, inserto incluido. Para anclaje químico



ZINCADO

CÓDIGO CODE	MEDIDA SIZE	DESCR.	PUNTA			€/ 100
CBV06*	M-6x70	BF06		10	320	52,84
03296	M-8x110	BF8	45°x2	10	200	79,24
NEW 03391	M-8x160	BF8	45°x2	10	80	119,85
03297	M-10x110	BF10	45°x2	10	200	92,54
03298	M-10x130	BF10	45°x2	10	200	86,01
NEW 03392	M-10x160	BF10	45°x2	10	80	146,60
03299	M-12x130	BF12	45°x2	10	80	125,90
03300	M-12x160	BF12	45°x2	10	200	119,92
03301	M-16x190	BF16	45°x2	10	80	321,84
03302	M-20x260	BF20	45°x2	5	30	631,85
03303	M-24x300	BF24	45°x2	5	5	995,49

* Corte recto, sin hexágono

ESPÁRRAGO ROSCADO / BFI

Con corte 45°

INOX A4 (AISI 316)

Para anclaje químico

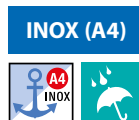

INOXIDABLE A4

CÓDIGO CODE	MEDIDA SIZE	DESCR.	PUNTA			€/ 100
03070	M-8x110	BF108	45°	10	160	348,93
03071	M-10x130	BF110	45°	10	160	587,19
03072	M-12x160	BF112	45°	10	80	1.198,19
03075	M-16x165	BF116	45°	10	80	2.308,39
03073	M-16x190	BF116	45°	10	80	2.755,06
03074	M-20x250	BF120	45°	5	25	3.464,76

ESPÁRRAGO ROSCADO / BFI

Con corte 90°

ACERO CL.8.8

Para anclaje químico en vial y cartucho completo con tuerca y arandela



ACERO CL.8.8

CÓDIGO CODE	MEDIDA SIZE	DESCR.	PUNTA			€/ 100
03370	10x130	BFD10	90°	10	160	273,20
03371	12x160	BFD12	90°	10	80	354,67
03372	16x190	BFD16	90°	10	60	609,44
03373	20x240	BFD20	90°	5	30	941,69

ACCESORIOS

PK11 PISTOLA PROFESIONAL DE NYLON

Para cartucho químico de 400 ml
- estructura en nylon reforzado
- mango central equilibrado
- gatillo con liberación automática de presión
- máxima suavidad de aplicación



CÓDIGO CODE	DESCR.			€/1
CP11	PK11	1	1	338,23

PK30 PISTOLA A BATERÍA

Para cartucho químico de 400 ml
Batería 14,4 V **Li-ion** - 3,0 Ah
Autonomía: 38 cartuchos con 1 batería
Fuerza de extrusión: 7500 N (750 kg)



Kit caja
1 pistola
1 batería Li-ion
1 cargador de batería

CÓDIGO CODE	DESCR.			€/1
CP30	KIT PK30 para 400 ml	1	1	2.737,55

PK17 PISTOLA A BATERÍA

Para cartucho químico de 300 ml y cartucho de silicona.
Batería 7,4 V **Li-ion**
Autonomía: 35 cartuchos de anclaje químico
50 cartuchos de silicona con 1 batería



Kit caja
1 pistola
1 batería Li-ion
1 cargador de batería

CÓDIGO CODE	DESCR.			€/1
* CP17	KIT PK17A BATERÍA para 300 ml	1	1	1.354,94

(*) HASTA FINAL DE EXISTENCIAS

CP17BA BATERÍA

Batería 7,4V **Li-ion**
para pistola CP17



CÓDIGO CODE	DESCR.			€/1
CP17BA	BATERÍA LI-ION para CP17	1	1	184,17
CP30BA	BATERÍA LI-ION para CP30	1	1	619,91

CP30BA BATERÍA

Batería 14,4V **Li-ion**
para pistola CP30



ACCESORIOS

PISTOLA NEUMÁTICA / CP16 PROFESIONAL

Para cartucho químico de 400 ml
- presión de trabajo de 3 a 10 bar
- nivel mínimo de ruido: 70 dBA
(solo durante la fase de descarga de aire)
- dimensiones: 455x80x245 mm
- peso neto: 1,88 kg



CÓDIGO CODE	DESCR.			€/1
CP16	PK16	1	1	1.289,17

PISTOLA / CP01

Para cartucho químico de 400 ml



CÓDIGO CODE	DESCR.			€/1
CP01	PK1	1	12	48,13

PISTOLA / CP05

Para cartucho químico de 345 ml



CÓDIGO CODE	DESCR.			€/1
CP05	PK5	1	10	60,41

PISTOLA PROFESIONAL / CP18 METÁLICA

Para cartucho químico de 385 ml EPO PLUS RE
resina epoxy



CÓDIGO CODE	DESCR.			€/1
CP18	PK18	1	10	127,50

PISTOLA PROFESIONAL / CP19 METÁLICA

Para cartucho químico de 385/585 ml EPO PLUS RE
resina epoxy



CÓDIGO CODE	DESCR.			€/1
CP19	PK19	1	10	138,13

PISTOLA SK / CP07 TIPO PROFESIONAL

Para cartucho químico de 300 - 175 - 150 ml
modelo con embrague



CÓDIGO CODE	DESCR.			€/1
CP07	SK2	1	12	38,32

ACCESORIOS

SOPLADOR PA para limpieza de agujeros

Presión de aire 5 Kg ÷ 7 Kg, salida de aire

Rotación del tubo: 360°

Longitud = 22,5 cm
Ø = 6 cm





CÓDIGO CODE	DESCR.			€/1
CP10	BOMBA DE AIRE PA	1	24	13,64

CEPILLO DE ACERO

Para limpieza de agujeros



CÓDIGO CODE	DESCR.			€/1
CSC010	SC10	-	10	8,74
CSC012	SC12	-	10	8,74
CSC014	SC14	-	10	8,74
CSC018	SC18	-	5	8,74
CSC024	SC24	-	5	8,74
CSC028	SC28	-	5	8,74

MEZCLADOR

Para anclaje químico





CÓDIGO CODE	DESCR.			€/100
CM12	CÁNULA PARA 300 Y 410	12	120	50,69
CM1001	CÁNULA PARA 300 Y 410, ENVASE INDUST.	-	1.000	36,00
CM1003	CÁNULA PARA 300 CON COLLAR	-	500	41,73
CM1004	CÁNULA CORTA PARA 300 CON COLLAR	-	1.000	29,33

PICO MEZCLADOR

Para anclaje EPO PLUS RE



CÓDIGO CODE	DESCR.			€/100
03064	CÁNULA CME, PARA EPO PLUS RE, CME12	12	72	304,60

EXTENSIÓN PARA MEZCLADOR

M17 y CME12



CÓDIGO CODE	DESCR.	LONGITUD			€/100
03357	PROLONGADOR PARA CÁNULAS	250	25	125	237,33

ACCESORIOS

TAMIZ PLÁSTICO, TRANSPARENTE

Para materiales huecos

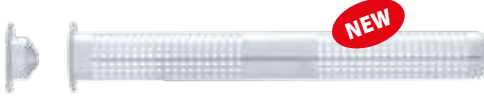

ETAG 029 cat. uso b,c,w/w
M8 - M12

CÓDIGO CODE	MEDIDA SIZE	DESCR.				€ / 100
CB10	10x45	BR10	M6	10	100	28,62
CB04	12x50	BR12	M6/8	10	100	28,30
CB08	12x60	BR14	M6/8	10	100	30,18
CB07	12x80	BR13	M6/8	10	100	31,12
CB01	16x85	BR15	M8/10	10	100	29,80
CB09	16x100	BR21	M8/10	10	100	34,24
CB02	16x130	BR16	M8/10	10	100	35,07
CB03	20x85	BR20	M12	10	50	36,74

TAMIZ PLÁSTICO, PASANTE

Para grandes espesores, recortable a medida

• evita los puentes térmicos en las aplicaciones del sistema, aislamiento de hasta 200 mm de espesor

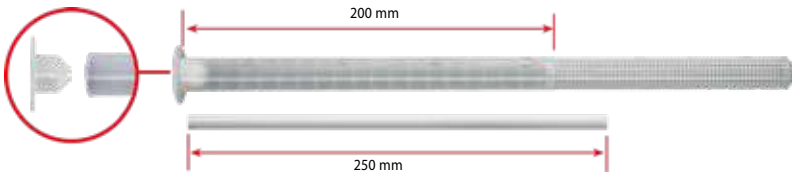

CÓDIGO CODE	MEDIDA SIZE	DESCR.				€ / 100
CB11	16x330/200	TAMIZ BR11	M8/M10	5	100	109,76
CB113357	16x330/200	TAMIZ+PROLONGADOR	M8/M10	5+5	100	207,47

TAMIZ METÁLICO 1 METRO



CÓDIGO CODE	MEDIDA SIZE	Ø AGUJERO Ø HOLE	DESCR.				€ / 100
CBAMD12	12x1000	12	BAM12	M8	-	10	1.654,58
CBAMD16	16x1000	16	BAM16	M8-M10	-	10	1.767,79
CBAMD22	22x1000	22	BAM22	M12-M16	-	5	2.159,67
CBAMD30	30x1000	30	BAM30	M20-M24	-	4	7.619,79

TAMIZ ROSCADO DE ACERO

Con rosca interior y capuchón



CÓDIGO CODE	MEDIDA SIZE	Ø AGUJERO Ø HOLE	DESCR.				€ / 100
CBA06	8x50	10	BA6	M6	25	800	88,21
CBA08	12x80	14	BA8	M8	25	400	176,79
CBA10	14x80	16	BA10	M10	20	320	208,48
CBA12	16x80	18	BA12	M12	20	320	228,53



asfalto
asphalt

GEB KIT ASFALTO

Sistema de fijación universal sobre asfalto

Completo con accesorio de cierre

Para usar con anclaje químico



CÓDIGO CODE	MEDIDA SIZE	DESCR.				€ / 100
* 03273	12x70	ASF1270	M10	20	640	498,67
* 03274	12x100	ASF12100	M10	20	320	600,00

(*) HASTA FINAL DE EXISTENCIAS

GEBIFOAM ESPUMAS DE POLIURETANO

ESPUMA POLIURETANO GEBIFOAM S750 y S670

TIPO S por extrusión manual
Certificación de aislamiento térmico y acústico
Clase B3

 Incluye un par de guantes para cumplir con las normas CE



CÓDIGO CODE	DESCR.	DURACIÓN MESES DURATION MONTHS	CONT.		€/1
CSM01	S670-MANUAL	18	670 ml	12	10,15
CS01	S750-MANUAL	18	750 ml	12	10,62

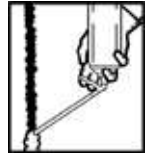

ESPUMA POLIURETANO GEBIFOAM P750

TIPO P extrusión a pistola
Certificación de aislamiento térmico y acústico
Clase B3

 Incluye un par de guantes para cumplir con las normas CE



CÓDIGO CODE	DESCR.	DURACIÓN MESES DURATION MONTHS	CONT.		€/1
CS02	P750-PISTOLA	18	750 ml	12	11,26

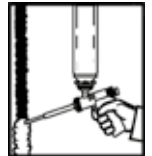

ESPUMA POLIURETANO GEBIFOAM B1

TIPO B1 por extrusión manual
AUTOEXTINGUIBLE
Certificación de **resistencia al fuego hasta 240 minutos Clase B1 con válvula de seguridad**

 Incluye un par de guantes para cumplir con las normas CE

● B1 AUTOEXTINGUIBLE HASTA 240 MINUTOS

VÁLVULA DE SEGURIDAD **EI 240**



CÓDIGO CODE	DESCR.	DURACIÓN MESES DURATION MONTHS	CONT.		€/1
CS03	B1-MANUAL	15	750 ml	12	19,37

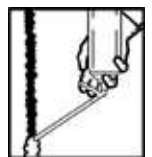

ESPUMA POLIURETANO GEBIFOAM B1

TIPO B1 por extrusión a pistola
AUTOEXTINGUIBLE
Certificación de **resistencia al fuego hasta 240 minutos Clase B1 con válvula de seguridad**

 Incluye un par de guantes para cumplir con las normas CE

● B1 AUTOEXTINGUIBLE HASTA 240 MINUTOS

VÁLVULA DE SEGURIDAD **EI 240**



CÓDIGO CODE	DESCR.	DURACIÓN MESES DURATION MONTHS	CONT.		€/1
CS21	B1-PISTOLA	15	750 ml	12	19,72

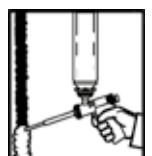

GEBIFOAM ESPUMAS DE POLIURETANO

ESPUMA POLIURETANO GEBIFOAM TETTI

TIPO P extrusión a pistola
TIPO S extrusión manual por extrusión manual y a pistola Clase B3

 Incluye un par de guantes para cumplir con las normas CE

● **ESPECIAL PARA TEJAS**



CÓDIGO CODE	DESCR.	DURACIÓN MESES DURATION MONTHS	CONT.		€/1
CS04	TEJAS P750-PISTOLA	18	750 ml	12	13,30
CS08	TEJAS S750-MANUAL	18	750 ml	12	12,89

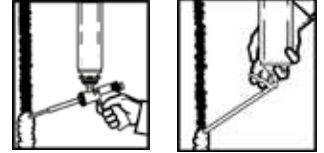

DETERGENTE PARA ESPUMA GEBIFOAM D500

Detergente para espuma de poliuretano

500 ml



CÓDIGO CODE	DESCR.	DURACIÓN MESES DURATION MONTHS	CONT.		€/1
CD01	D500	12	500 ml	12	8,46

PSP1 PISTOLA PROFESIONAL PARA ESPUMA POLIURETANO GEBIFOAM

Ligero y práctico
Mango ergonómico



CÓDIGO CODE	DESCR.			€/1
CP03	PSP1	-	1	39,73



GEBOTeC
Professional

LUBRIEXTRA HQ 10F

Lubricante protector 10 funciones
Válvula especial de doble posición 360°

Nueva formulación de MOS2 y grafito. Excelente en muchos sectores: taller, náutica, industria mecánica, sector eléctrico, sector automóvil, mantenimiento doméstico, en el jardín, en la industria. Prolonga la vida de engranajes, piezas mecánicas y de caucho, mejorando su eficiencia.

La válvula de doble posición de 360° garantiza al mismo tiempo una dosificación amplia para superficies más grandes y una dosificación precisa para el cuidado de las partes mecánicas más pequeñas y de más difícil acceso.



CÓDIGO CODE	DESCR.	CONT.		€/1
84022	GT -10F	400	12	15,80



- LUBRICANTE - ANTICORROSIVO - PROTECTOR - DESENGRASANTE - LIMPIADOR - DESBLOQUEADOR ANTIGRIPIANTE - ANTICONGELANTE - IMPERMEABLE - DIELECTRICO - ANTI-GRIETAS RESISTENTE A ALTAS TEMPERATURAS Y A LOS AGENTES ATMOSFÉRICOS

LUBRI FORTE-8F

Lubricante protector 8 funciones

Gracias a la formulación con MOS2 tiene propiedades altamente lubricantes y anticorrosivas penetrando profundamente en engranajes y dispositivos mecánicos.

Indispensable en los sectores: taller, garaje, náutica, industria mecánica, mantenimiento doméstico, en el jardín, en la industria pesada y mantenimiento en general. Alarga la vida de engranajes y piezas mecánicas, mejorando su eficiencia.



CÓDIGO CODE	DESCR.	CONT.		€/1
84013	GT -8F	400	12	9,28



- LUBRICANTE - ANTICORROSIVO - PROTECTOR - DESENGRASANTE - DESBLOQUEO / ANTIAGARRE ANTICONGELANTE - HIDRÓFUGO - ANTI-GRIETAS

DESBLOQUEANTE RÁPIDO

Protección contra la oxidación de múltiples fines.

Fluido sintético con alto poder solvente y desatascador, libera rápidamente tuercas, pernos, juntas, roscas, cerraduras, candados, bisagras, cadenas, equipos mecánicos y herramientas manuales del óxido. Forma un velo protector duradero, e hidrófugo. Prolonga la vida útil de los engranajes y evita el desgaste.



CÓDIGO CODE	DESCR.	CONT.		€/1
84007	GT -SB07	400	12	9,27



- MULTIUSO

GEBOTeC
Professional

GRASO MULTIUSO

Alta viscosidad

Incluso en condiciones difíciles.

Fluido de alta calidad y alta viscosidad con alto poder de penetración. Protege del agua y de los agentes atmosféricos, resistente en ambientes salinos y polvorientos, resistente a soluciones básicas y ácidas. Penetra profundamente en los engranajes prolongando su vida y eficiencia.

Ideal para la lubricación de rodamientos, cadenas, líneas de transmisión, equipos marinos, embarcaciones, juntas, pasadores, guías y en general en el sector automotriz, máquinas agrícolas e industriales, dispositivos de transmisión de alta velocidad y altas temperaturas de operación.



CÓDIGO CODE	DESCR.	CONT.		€/1
84008	GT-GR08	400	12	10,40



● ALTA VISCOSIDAD

ACEITE DE VASELINA PURO

Lubricante protector

Inodoro, incoloro, no mancha. Ideal para lubricar y proteger instrumentos de precisión, bisagras, cerraduras, herramientas, engranajes, transmisiones, máquinas textiles y de oficina, mesas deslizantes en línea y maquinaria alimentaria, para uso profesional y doméstico. Crea una película fluida impermeabilizante y elastizante sobre la madera, evitando que se agriete. Mantiene la piel y el cuero suaves y flexibles. Adecuado para metales, caucho, madera, piel y cuero.



CÓDIGO CODE	DESCR.	CONT.		€/1
84011	GT-VS11	400	12	8,60



● LUBRICANTE - PURO

ACEITE DE CORTE PARA TROQUELES

Producto innovador con acción lubricante y protectora, a base de bases minerales parafínicas enriquecidas con aditivos especiales antisoldadura EP. Para aplicaciones profesionales en el mecanizado y corte de metales de alta dureza, y para el mantenimiento de herramientas y equipos de cadena de suministro. Ideal para operaciones pesadas de roscado y roscado en aceros particularmente duros y aleados. También apto para el sector hidráulico.



CÓDIGO CODE	DESCR.	CONT.		€/1
84010	GT-CUT10	400	12	10,80



● LUBRICANTE PARA TROQUELES

GEBOTeC
Professional

ZINC BRILLANTE

Spray protector de zinc brillante

Antioxidante - anticorrosión

Acción galvanizante en frío

Ideal para retoques y acabados de juntas, soldadura y reparación de piezas galvanizadas. Da un efecto brillante a las superficies pintadas. Excelente resistencia a la corrosión, oxidación y agentes atmosféricos en todos los materiales ferrosos. Crea un protector de alta elasticidad que resiste el agrietamiento y la decoloración. Puede dejarse como protección final o lijarse y/o repintarse. Espesor de capa: 15/20 micras. Rendimiento: 2/2,5 m² por bote. Tiempo de secado: unos 15/20 minutos.



CÓDIGO CODE	DESCR.	CONT.		€/1
84006	GT -Z06	400	12	10,53



● **PROTECTOR - ANTIÓXIDO**

ZINC OSCURO 98%

Zinc orgánico a base de resinas de tipo sintético, conteniendo zinc puro micronizado en altas cantidades y aluminio que se utiliza para obtener un tono de color gris medio. Excelente resistencia a los agentes corrosivos. Se puede utilizar como acabado final y es pintable. Seca muy rápidamente y en 8-10 minutos la superficie tratada es trabajable. Ideal para retoques, acabados y reparaciones de piezas galvanizadas.



CÓDIGO CODE	DESCR.	CONT.		€/1
84030	GT -ZINC98	400	12	11,13



● **ALTA PROTECCIÓN**

SILICONA IMPERMEABILIZANTE HQ

Alta calidad - protección extra

Spray de silicona de alto rendimiento para la industria del plástico, caucho y corte. Incoloro, inodoro, libre de solventes. Ideal como desmoldeante para moldes de plástico. Protector y lubricante, libera una película impermeable sobre cualquier tipo de material tratado, evitando la acumulación de cargas electrostáticas.

Es eficaz como abrillantador y protector de piezas de plástico y protege las juntas del agrietamiento, aumentando su estanqueidad y duración. También se utiliza en el sector náutico, camping y doméstico. No pintable



CÓDIGO CODE	DESCR.	CONT.		€/1
84009	GT -HQ09	400	12	9,53



● **IMPERMEABILIZANTE**

GEBOTeC
Professional

ELIMINADOR DE SILICONA

Solvente rápido no agresivo

Para todas las superficies

Formulación a base de disolventes adecuados para disolver y eliminar excesos y residuos de silicona. Acción inmediata sobre silicona fresca, requiere un tiempo de reacción corto sobre silicona endurecida. En el caso de una gran cantidad de silicona, se recomienda eliminar mecánicamente la mayor cantidad posible antes de aplicar el producto. Apto para cualquier superficie. No es agresivo. No opacifica.



CÓDIGO CODE	DESCR.	CONT.		€/1
84012	GT-RS12	400	12	10,19



● RÁPIDO - NO AGRESIVO

LIMPIADOR DE FRENOS Y PARTES MECÁNICAS

Limpiador especial particularmente efectivo para frenos, embragues y todas las partes mecánicas que necesitan ser desengrasadas sin enjuagar. Disuelve y elimina rápidamente aceites, grasas y cualquier otro tipo de suciedad. Especialmente indicado para engranajes mecánicos de alto rendimiento

500 ml



CÓDIGO CODE	DESCR.	CONT.		€/1
84027	GT-27	500	12	10,61



● RÁPIDO - SIN ACLARADO

AGENTE DE LIBERACIÓN DE SOLDADURA

Producto a base de polímeros sintéticos filmógenos que evitan la adherencia de las gotas de soldadura a cualquier soporte. La película protectora evita la formación de óxidos y la posible corrosión por agentes químicos. Es adecuado para soldaduras autógenas, eléctricas y a base de gas inerte. El compuesto está libre de sustancias de silicona.



CÓDIGO CODE	DESCR.	CONT.		€/1
84031	GT-SALD	400	12	9,87



● PELÍCULA PROTECTORA

GEBOTeC
Professional

LIMPIADOR DE CONTACTOS ELÉCTRICOS

Específico para la limpieza profunda de contactos eléctricos, electrónicos y electromagnéticos. Elimina instantáneamente la humedad y las sustancias grasas presentes en la superficie como grasas, aceites, lodos, ceras y colas, dejando la parte tratada limpia y desengrasada. Si se utiliza sobre superficies especialmente delicadas, podría resultar agresivo y dañarlas.



CÓDIGO CODE	DESCR.	CONT.		€/1
84029	GT -PE	400	12	8,93



● EFICACIA INMEDIATA - PROLONGA LA VIDA DE LOS CONTACTOS ELÉCTRICOS - DESOXIDANTE

GT-SLIDER DESILIZANTE DE CABLE PARA TUBERÍAS Y CABLES ELÉCTRICOS

Lubricante/spray, facilita el montaje de tubos y accesorios de caucho y plástico (PVC y PP) con junta anular. Excelente en el sector de la fontanería y calefacción.

Ideal en el sector eléctrico y de autoelectricidad. Elimina la fricción, facilitando la inserción de cables, protege y lubrica, no daña los materiales aislantes y ayuda a retardar el proceso natural de envejecimiento.



CÓDIGO CODE	DESCR.	CONT.		€/1
84053	GT -SLIDER	400	12	9,47



● FACILITA EL MONTAJE DE TUBOS Y CABLE ELÉCTRICO - PROLONGA LA VIDA DEL MATERIAL

LIMPIADOR DE ALTA PRESIÓN (AIRE COMPRIMIDO)

Elimina inmediatamente el polvo depositado en las superficies menos accesibles. Está indicado para la limpieza de lentes, lentes, computadoras, relojes y mecánica en general.



CÓDIGO CODE	DESCR.	CONT.		€/1
84032	GT -AP	400	12	9,47



● PARA LENTES - ÓPTICA - COMPUTADORAS - HERRAMIENTAS DE PRECISIÓN Y MECÁNICA



**GEBOTEC TRACCIA TR360
SPRAY TRAZADOR 360°**

Pintura trazadora en spray específica para albañilería, suelos, asfalto, hormigón, madera. Alta resistencia al desgaste ya los agentes atmosféricos. Disponible en colores fluorescentes. El producto se puede utilizar en todas las posiciones ya que está equipado con una "válvula de 360°" especial.



CÓDIGO CODE	DESCR.	CONT.		€/l
84039	GT-TR360 BLANCO	500	12	14,07
84040	GT-TR360 NEGRO	500	12	14,07
84041	GT-TR360 AZUL FLUO	500	12	14,07
84042	GT-TR360 ROJO FLUO	500	12	14,07
84043	GT-TR360 NARANJA FLUO	500	12	14,07
84044	GT-TR360 AMARILLO FLUO	500	12	14,07
84045	GT-TR360 VERDE FLUO	500	12	14,07

● PINTABLE - SECADO RÁPIDO - ALTA VISIBILIDAD - COLORES FLUORESCENTES



SOMOS FABRICANTES DESDE 1980

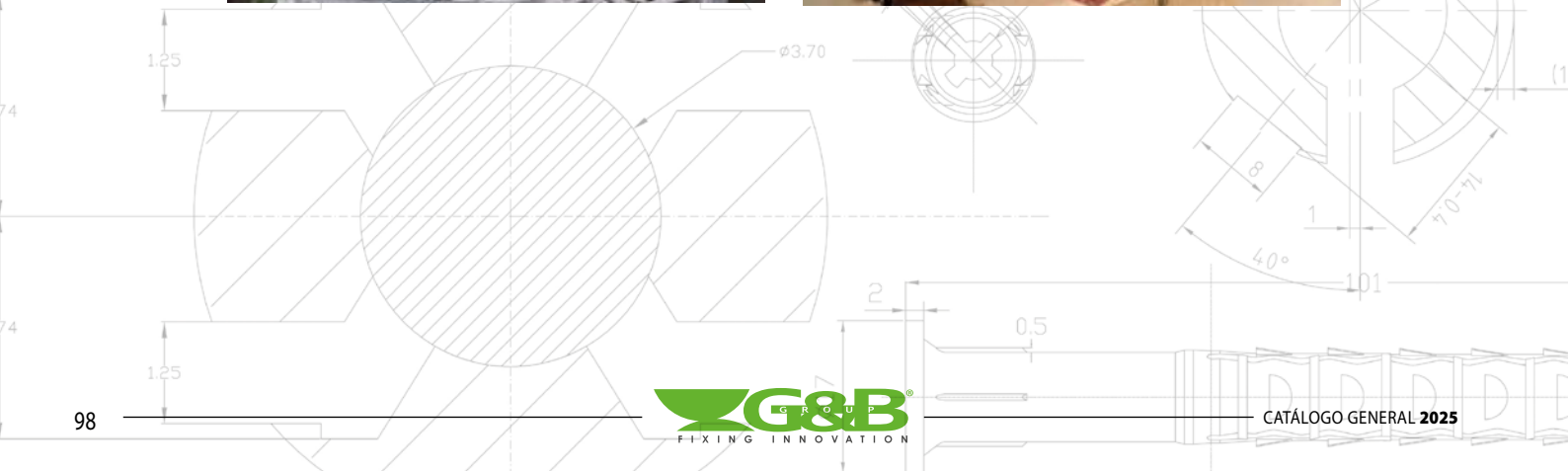

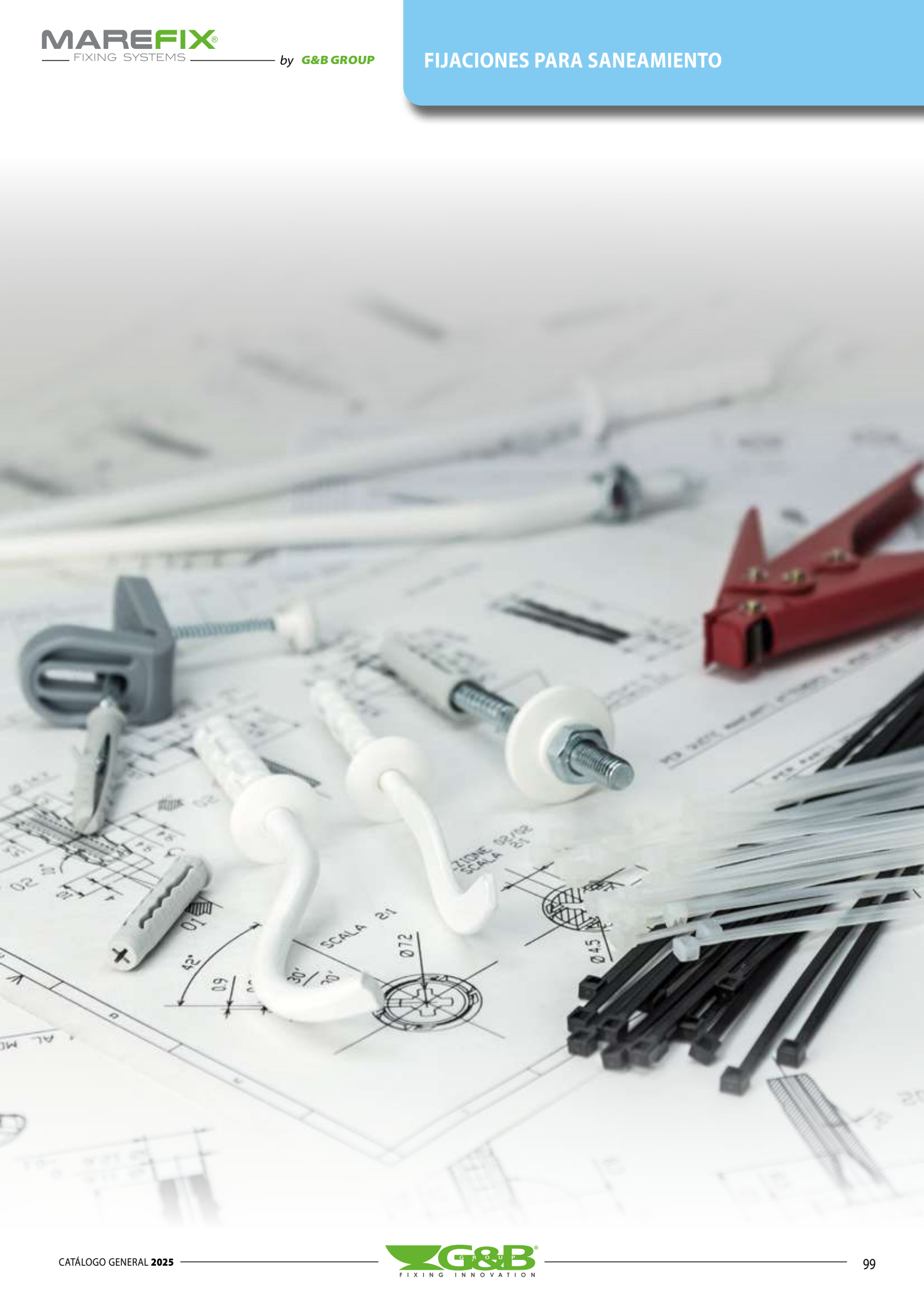

BRIDAS DE NYLON

BR-BLANCA

Brida de nylon
Color **NATURAL / BLANCO**



POLIAMIDA 6.6

CÓDIGO CODE	MRF	MEDIDA SIZE			€/ 100
HFB0825	BRB25080	2,5x 80	100	1.000	1,03
HFB1025	BRB25100	2,5x100	100	1.000	1,19
HFB1425	BRB25140	2,5x140	100	1.000	1,88
HFB1625	BRB25160	2,5x160	100	1.000	2,10
HFB2025	BRB25200	2,5x200	100	1.000	2,46
HFB1436	BRB36140	3,6x140	100	1.000	2,69
HFB2036	BRB36200	3,6x200	100	1.000	3,94
HFB2536	BRB36250	3,6x250	100	1.000	4,70
HFB2936	BRB36290	3,6x290	100	1.000	5,73
HFB3036	BRB36300	3,6x300	100	1.000	5,73
HFB3636	BRB36360	3,6x360	100	1.000	7,16
HFB3736	BRB36370	3,6x370	100	1.000	7,03
HFB1248	BRB48120	4,8x120	100	1.000	3,13
HFB1648	BRB48160	4,8x160	100	1.000	4,07
HFB1848	BRB48180	4,8x180	100	1.000	4,75
HFB2048	BRB48200	4,8x200	100	1.000	4,84
HFB2548	BRB48250	4,8x250	100	1.000	6,36
HFB2948	BRB48290	4,8x290	100	1.000	7,52
HFB3648	BRB48360	4,8x360	100	1.000	9,40
HFB3748	BRB48370	4,8x370	100	1.000	9,54
HFB3948	BRB48390	4,8x390	100	1.000	11,01

BR-NEGRA

Brida de nylon
Color **NEGRO**



POLIAMIDA 6.6

CÓDIGO CODE	MRF	MEDIDA SIZE			€/ 100
HFN0825	BRN25080	2,5x 80	100	1.000	1,03
HFN1025	BRN25100	2,5x100	100	1.000	1,19
HFN1425	BRN25140	2,5x140	100	1.000	1,88
HFN1625	BRN25160	2,5x160	100	1.000	2,10
HFN2025	BRN25200	2,5x200	100	1.000	2,46
HFN1436	BRN36140	3,6x140	100	1.000	2,69
HFN2036	BRN36200	3,6x200	100	1.000	3,94
HFN2536	BRN36250	3,6x250	100	1.000	4,70
HFN2936	BRN36290	3,6x290	100	1.000	5,73
HFN3036	BRN36300	3,6x300	100	1.000	5,73
HFN3636	BRN36360	3,6x360	100	1.000	7,16
HFN3736	BRN36370	3,6x370	100	1.000	7,03
HFN1248	BRN48120	4,8x120	100	1.000	3,13
HFN1648	BRN48160	4,8x160	100	1.000	4,07
HFN1848	BRN48180	4,8x180	100	1.000	4,75
HFN2048	BRN48200	4,8x200	100	1.000	4,84
HFN2548	BRN48250	4,8x250	100	1.000	6,36
HFN2948	BRN48290	4,8x290	100	1.000	7,52
HFN3648	BRN48360	4,8x360	100	1.000	9,40
HFN3748	BRN48370	4,8x370	100	1.000	9,54
HFN3948	BRN48390	4,8x390	100	1.000	11,01



tubo de acero steel tube tubo de cobre copper tube tubo de PVC PVC tube tubo flexible flexible tube cable eléctrico electric cable



POLIAMIDA 6.6

CÓDIGO CODE	MRF	MEDIDA SIZE			€/ 100
HFB4348	BRB48430	4,8x430	100	1.000	12,18
HFB5348	BRB48530	4,8x530	100	1.000	15,67
HFB1576	BRB76150	7,6x150	100	500	7,48
HFB2076	BRB76200	7,6x200	100	500	10,07
HFB2576	BRB76250	7,6x250	100	500	12,09
HFB2976	BRB76290	7,6x290	100	500	14,42
HFB3676	BRB76360	7,6x360	100	500	17,82
HFB3776	BRB76370	7,6x370	100	500	17,37
HFB4576	BRB76450	7,6x450	100	500	22,03
HFB5476	BRB76540	7,6x540	100	500	30,36
HFB7576	BRB76750	7,6x750	100	500	42,27
HFB7788	BRB88770	8,8x770	100	500	53,10
HFB7888	BRB88780	8,8x780	100	500	55,97
HFB5390	BRB90530	9,0x530	100	500	44,05
HFB10290	BRB90102	9,0x1020	100	500	69,04
HFB22125	BRB12225	12,5x 225	100	500	30,45
HFB50125	BRB12500	12,5x 500	100	500	55,97
HFB72125	BRB12720	12,5x 720	100	500	78,90
HFB85125	BRB12850	12,5x 850	100	500	87,40
HFB100125	BRB12100	12,5x1000	100	500	108,00



tubo de acero steel tube tubo de cobre copper tube tubo de PVC PVC tube tubo flexible flexible tube cable eléctrico electric cable



POLIAMIDA 6.6

CÓDIGO CODE	MRF	MEDIDA SIZE			€/ 100
HFN4348	BRN48430	4,8x430	100	1.000	12,18
HFN5348	BRN48530	4,8x530	100	1.000	15,67
HFN1576	BRN76150	7,6x150	100	500	7,48
HFN2076	BRN76200	7,6x200	100	500	10,07
HFN2576	BRN76250	7,6x250	100	500	12,09
HFN2976	BRN76290	7,6x290	100	500	14,42
HFN3676	BRN76360	7,6x360	100	500	17,82
HFN3776	BRN76370	7,6x370	100	500	17,37
HFN4576	BRN76450	7,6x450	100	500	22,03
HFN5476	BRN76540	7,6x540	100	500	30,36
HFN7576	BRN76750	7,6x750	100	500	42,27
HFN7788	BRN88770	8,8x770	100	500	53,10
HFN7888	BRN88780	8,8x780	100	500	55,97
HFN5390	BRN90530	9,0x530	100	500	44,05
HFN10290	BRN90102	9,0x1020	100	500	69,04
HFN22125	BRN12225	12,5x225	100	500	30,45
HFN50125	BRN12500	12,5x500	100	500	55,97
HFN72125	BRN12720	12,5x720	100	500	78,90
HFN85125	BRN12850	12,5x850	100	500	87,40
HFN100125	BRN12100	12,5x1.000	100	500	108,00

BRIDAS DE NYLON



tubo de acero
steel tube

tubo de cobre
copper tube

tubo de PVC
PVC tube

tubo flexible
flexible tube

cable eléctrico
electric cable

BRIDA CABEZA ESPECIAL

Color **NEGRO**



POLIAMIDA 6.6

CÓDIGO CODE	MEDIDA SIZE	DESCR.			€ / 100
HFN1890	9,0x180	UNA CABEZA	500	2.000	16,12
HFN2690	9,0x260	CABEZA DOBLE	100	1.500	25,05
HFN3690	9,0x360	CABEZA DOBLE	100	1.500	31,77

BR-GRIS

Brida de nylon
Color **GRIS**, RAL 7035



POLIAMIDA 6.6

CÓDIGO CODE	MEDIDA SIZE			€ / 100
BRG25100	2,5x100	100	1.000	1,26
BRG36140	3,6x140	100	1.000	3,00
BRG36200	3,6x200	100	1.000	3,94
BRG48200	4,8x200	100	1.000	5,10
BRG48290	4,8x290	100	1.000	7,97

RAL 7035



P.205

BR-VERDE

Brida de nylon
Color **VERDE**, RAL 6032



POLIAMIDA 6.6

CÓDIGO CODE	MEDIDA SIZE			€ / 100
BRV25100	2,5x100	100	1.000	1,26
BRV36140	3,6x140	100	1.000	3,00
BRV36200	3,6x200	100	1.000	3,94
BRV48200	4,8x200	100	1.000	5,10
BRV48290	4,8x290	100	1.000	7,97

RAL 6032

BR-MARRÓN

Brida de nylon
Color **MARRÓN**, RAL 8011



POLIAMIDA 6.6

CÓDIGO CODE	MEDIDA SIZE			€ / 100
BRM25100	2,5x100	100	1.000	1,26
BRM36140	3,6x140	100	1.000	3,00
BRM36200	3,6x200	100	1.000	3,94
BRM48200	4,8x200	100	1.000	5,10
BRM48290	4,8x290	100	1.000	7,97

RAL 8011

BR-AMARILLA

Brida de nylon
Color **AMARILLO**, RAL 1021



POLIAMIDA 6.6

CÓDIGO CODE	MEDIDA SIZE			€ / 100
BRA25100	2,5x100	100	1.000	1,26
BRA36140	3,6x140	100	1.000	3,00
BRA36200	3,6x200	100	1.000	3,94
BRA48200	4,8x200	100	1.000	5,10
BRA48290	4,8x290	100	1.000	7,97

RAL 1021

BRIDAS DE NYLON



tubo de acero
steel tube

tubo de cobre
copper tube

tubo de PVC
PVC tube

tubo flexible
flexible tube

cable eléctrico
electric cable

BR-AZUL

Brida de nylon
Color **AZUL**, RAL 5010



POLIAMIDA 6.6

CÓDIGO CODE	MEDIDA SIZE			€/ 100
BRZ25100	2,5x100	100	1.000	1,26
BRZ36140	3,6x140	100	1.000	3,00
BRZ36200	3,6x200	100	1.000	3,94
BRZ48200	4,8x200	100	1.000	5,10
BRZ48290	4,8x290	100	1.000	7,97

RAL 5010

BR-ROJA

Brida de nylon
Color **ROJO**, RAL 3000



POLIAMIDA 6.6

CÓDIGO CODE	MEDIDA SIZE			€/ 100
BRR25100	2,5x100	100	1.000	1,26
BRR36140	3,6x140	100	1.000	3,00
BRR36200	3,6x200	100	1.000	3,94
BRR48200	4,8x200	100	1.000	5,10
BRR48290	4,8x290	100	1.000	7,97

RAL 3000

BR-DETECTABLE

Brida de nylon
Color **AZUL**



MAGNÉTICA



RAYOS X

POLIAMIDA 6.6

CÓDIGO CODE	MEDIDA SIZE			€/ 100
BRDET25100	2,5x100	100	1.000	2,42
BRDET36150	3,6x150	100	1.000	5,55
BRDET36200	3,6x200	100	1.000	7,43
BRDET48200	4,8x200	100	1.000	9,45
BRDET48300	4,8x300	100	1.000	14,60
BRDET48370	4,8x370	100	1.000	19,88
BRDET76370	7,6x370	100	1.000	36,63

BR-IDENTIFI

Brida de nylon para IDENTIFICACIÓN
Color **NATURAL / BLANCO**



POLIAMIDA 6.6

CÓDIGO CODE	MEDIDA SIZE			€/ 100
BRID25100	2,5x100	100	1.000	3,85
BRID25200	2,5x200	100	1.000	4,48

BRIDAS DE NYLON



tubo de acero
steel tube

tubo de cobre
copper tube

tubo de PVC
PVC tube

tubo flexible
flexible tube

cable eléctrico
electric cable



P.205

BR-TACO BL

Taco para bridas nylon
Color **NATURAL / BLANCO**



POLIAMIDA 6.6

CÓDIGO CODE	MRF	MEDIDA SIZE			€/ 100
HTFB02	TABRIBL06	Ø 6	100	5.000	7,21
HTFB01	TABRIBL08	Ø 8	100	1.200	6,55



P.205

BR-TACO NG

Taco para bridas nylon
Color **NEGRO**



POLIAMIDA 6.6

CÓDIGO CODE	MRF	MEDIDA SIZE			€/ 100
HTFN02	TABRINE06	Ø 6	100	5.000	6,41
HTFN01	TABRINE08	Ø 8	100	1.200	6,13

BR-TACO GR

Taco para bridas nylon
Color **GRIS**



POLIAMIDA 6.6

CÓDIGO CODE	MRF	MEDIDA SIZE			€/ 100
HTFG01	TABRIGR08	Ø 8	100	1.200	6,45

BASE BL/NG

Base dos vías adhesiva



BLANCA / POLIAMIDA 6.6

CÓDIGO CODE	MRF	MEDIDA SIZE			€/ 100
HBD01	BRBABL19	19x19	100	10.000	6,21
HBD02	BRBABL28	28x28	100	5.000	11,52

NEGRA / POLIAMIDA 6.6

CÓDIGO CODE	MRF	MEDIDA SIZE			€/ 100
HBN01	BRBANE19	19x19	100	10.000	6,21
HBN02	BRBANE28	28x28	100	5.000	11,52

PINZA COLOCACIÓN BRIDAS



CÓDIGO CODE	DESCR.	LONGITUD MÁX. BRIDA			€/ 1
TK40	PF01	9	1	10	31,30

CINTA PERFORADA



tubo de acero steel tube tubo de cobre copper tube tubo de PVC PVC tube tubo flexible flexible tube cable eléctrico electric cable

CINPER

Cinta perforada ondulada



GALVANIZADA

CÓDIGO CODE	MEDIDA SIZE	DESCR.	← m →			€ / 1
CINPEZ1208	12x0,8	-	10	1	10	7,13
CINPEZ1708	17x0,8	-	10	1	10	8,73

INOXIDABLE A2

CÓDIGO CODE	MEDIDA SIZE	DESCR.	← m →			€ / 1
CINPEI1708	17x0,8	-	10	1	10	27,55

ZINCADO

CÓDIGO CODE	MEDIDA SIZE	DESCR.	← m →			€ / 100
850011	12x0,8	BPD12D	10	1	10	933,33
850028	17x0,8	BPD17D	10	1	10	1.232,00

CINTA PERFORADA, BPD / D

Cinta perforada recta



ZINCADO

CÓDIGO CODE	MEDIDA SIZE	DESCR.	← m →			€ / 100
850035	17x0,8	BPD17E	10	1	10	1.269,33
850066	25x0,8	BPD25E	10	1	5	2.634,67

CINTA PERFORADA, BPD / E

Cinta perforada multiagujeros



CINTA DE TEJIDO, BT



CÓDIGO CODE	MEDIDA SIZE	DESCR.	← m →			€ / 100
85007	16x0,8	BT1610	10	1	10	442,67
85008	16x0,8	BT1625	25	1	10	960,00

CLAVO DE PERCUSIÓN, GEBOPIN

Para fijar la cinta de tejido



ZINCADO

CÓDIGO CODE	MEDIDA SIZE	DESCR.			€ / 100
TCHI14	4x14	GP1	200	4.000	10,07
TCHI18	4x18	GP2	200	4.000	10,67
TCHI22	4x22	GP3	200	4.000	11,20
TCHI27	4x27	GP4	100	2.000	16,00

PERCUTOR PARA CLAVO GEBOPIN



CÓDIGO CODE	DESCR.			€ / 1
TK50	PGP	1	5	51,00



TORNILLOS PARA **ALUMINIO / ACERO**



TORNILLOS PARA **MADERA**



TORNILLOS PARA **YESO LAMINADO**



DIN-7504-K / TBE

Tornillo autotaladrante, **CABEZA HEXAGONAL**,
arandela estampada



ensamblaje de chapas
metal panels

perfiles de chapa
metal elements



BOCAS / VASOS

DISPONIBLE, VER PÁGINA:

P. 131



DISPONIBLE EN
COLORES RAL



ZINCADO

CÓDIGO CODE	MEDIDA SIZE		CAP.	MAX.			€/ 100
TBEZ3509	3,5x9,5	6	2,25 Max.	2,85	1.000	24.000	2,17
TBEZ3513	3,5x13	6	2,25 Max.	6,20	1.000	12.000	2,24
TBEZ3516	3,5x16	6	2,25 Max.	9,20	1.000	12.000	2,59
TBEZ3519	3,5x19	6	2,25 Max.	12,10	1.000	12.000	2,75
TBEZ4213	4,2x13	7	3,00 Max.	4,30	1.000	12.000	3,13
TBEZ4216	4,2x16	7	3,00 Max.	7,30	1.000	8.000	3,33
TBEZ4219	4,2x19	7	3,00 Max.	10,30	1.000	8.000	3,75
TBEZ4225	4,2x25	7	3,00 Max.	16,30	500	6.000	4,46
TBEZ4232	4,2x32	7	3,00 Max.	23,00	500	6.000	5,07
TBEZ4238	4,2x38	7	3,00 Max.	29,00	500	6.000	5,84
TBEZ4813	4,8x13	8	4,40 Max.	3,70	1.000	8.000	4,12
TBEZ4816	4,8x16	8	4,40 Max.	5,50	1.000	6.000	4,13
TBEZ4819	4,8x19	8	4,40 Max.	8,70	500	6.000	4,59
TBEZ4825	4,8x25	8	4,40 Max.	14,70	500	6.000	5,18
TBEZ4832	4,8x32	8	4,40 Max.	21,50	500	3.000	6,42
TBEZ4838	4,8x38	8	4,40 Max.	27,50	500	3.000	7,12
TBEZ4850	4,8x50	8	4,40 Max.	39,50	500	3.000	9,06
TBEZ4860	4,8x60	8	4,40 Max.	49,50	250	1.500	9,39
TBEZ4870	4,8x70	8	4,40 Max.	59,50	250	1.500	15,00
TBEZ5519	5,5x19	8	5,25 Max.	8,70	500	4.000	6,06
TBEZ5522	5,5x22	8	5,25 Max.	11,70	500	4.000	6,30
TBEZ5525	5,5x25	8	5,25 Max.	14,70	500	4.000	6,69
TBEZ5532	5,5x32	8	5,25 Max.	21,50	500	3.000	7,96
TBEZ5538	5,5x38	8	5,25 Max.	27,50	500	3.000	9,04
TBEZ5550	5,5x50	8	5,25 Max.	39,50	500	2.000	11,07
TBEZ5563	5,5x63	8	5,25 Max.	52,50	250	1.500	13,39
TBEZ5575	5,5x75	8	5,25 Max.	64,50	250	1.500	16,40
TBEZ6319	6,3x19	10	6,00 Max.	7,00	500	3.000	9,36
TBEZ6325	6,3x25	10	6,00 Max.	13,00	500	3.000	9,91
TBEZ6332	6,3x32	10	6,00 Max.	20,00	500	3.000	11,51
TBEZ6338	6,3x38	10	6,00 Max.	26,00	500	3.000	12,92
TBEZ6350	6,3x50	10	6,00 Max.	38,00	250	1.500	15,84
TBEZ6363	6,3x63	10	6,00 Max.	51,00	250	1.500	18,73
TBEZ6375	6,3x75	10	6,00 Max.	63,00	250	1.000	21,92
TBEZ6380	6,3x80	10	6,00 Max.	68,00	250	1.000	24,37
TBEZ6390	6,3x90	10	6,00 Max.	78,00	250	750	28,70
TBEZ6310	6,3x100	10	6,00 Max.	88,00	100	600	30,84
TBEZ6311	6,3x110	10	6,00 Max.	98,00	100	600	37,93
TBEZ6312	6,3x120	10	6,00 Max.	108,00	100	600	44,01
TBEZ6313	6,3x130	10	6,00 Max.	118,00	100	600	49,37
TBEZ6314	6,3x140	10	6,00 Max.	128,00	100	600	57,71
TBEZ6315	6,3x150	10	6,00 Max.	138,00	100	400	68,85
TBEZ6316	6,3x160	10	6,00 Max.	148,00	100	400	76,43
TBEZ6318	6,3x180	10	6,00 Max.	168,00	100	300	98,90
TBEZ6320	6,3x200	10	6,00 Max.	188,00	100	300	126,23
TBEZ6322	6,3x220	10	6,00 Max.	208,00	100	300	159,86
TBEZ6324	6,3x240	10	6,00 Max.	228,00	100	900	180,53

DIN-7504-K / TBE+ARNE

Con Arandela de EPDM montada
En cubo de plástico, reutilizable



CÓDIGO CODE	MEDIDA SIZE		€/ 1
TBE144819BP	4,8x19, Montado / Assembled P-14	1.250	101,73
TBE164819BP	4,8x19, Montado / Assembled P-16	1.250	109,58
TBE165522BP	5,5x22, Montado / Assembled P-16	1.250	132,18
TBE166325BP	6,3x25, Montado / Assembled P-16	750	106,34
NEW TBE166338BP	6,3x38, Montado / Assembled P-16	500	92,86



BOCAS / VASOS

DISPONIBLE, VER PÁGINA:

P.131



DISPONIBLE EN
COLORES RAL



DIN-7504-K / TBE+ARNE

Con Arandela de EPDM, montada



MEDIDAS EN COLOR ROJO, CONSULTAR PLAZO

		ARANDELA MONTADA P-14			ARANDELA MONTADA P-16			ARANDELA MONTADA P-18			ARANDELA MONTADA P-25		
MEDIDA SIZE	CÓDIGO CODE		€/ 100	CÓDIGO CODE		€/ 100	CÓDIGO CODE		€/ 100	CÓDIGO CODE		€/ 100	
3,5x9,5	TBE143509	1.000	12,29	TBE163509	1.000	12,51	TBE183509	500	14,52	TBE253509	250	19,66	
3,5x13	TBE143513	1.000	12,57	TBE163513	1.000	12,74	TBE183513	500	14,75	TBE253513	250	20,17	
3,5x16	TBE143516	1.000	12,68	TBE163516	1.000	12,90	TBE183516	500	15,03	TBE253516	250	20,28	
3,5x19	TBE143519	1.000	13,02	TBE163519	1.000	13,13	TBE183519	500	15,25	TBE253519	250	20,56	
4,2x13	TBE144213	1.000	13,69	TBE164213	1.000	13,85	TBE184213	500	16,03	TBE254213	250	21,34	
4,2x16	TBE144216	1.000	14,08	TBE164216	1.000	14,24	TBE184216	500	16,37	TBE254216	250	21,67	
4,2x19	TBE144219	1.000	8,17	TBE164219	1.000	10,65	TBE184219	500	16,70	TBE254219	250	22,01	
4,2x25	TBE144225	1.000	11,14	TBE164225	1.000	15,08	TBE184225	500	17,26	TBE254225	250	22,57	
4,2x32	TBE144232	1.000	15,70	TBE164232	1.000	15,98	TBE184232	500	17,99	TBE254232	250	23,24	
4,2x38	TBE144238	1.000	16,53	TBE164238	1.000	16,65	TBE184238	500	18,99	TBE254238	250	23,96	
4,8x13	TBE144813	1.000	14,86	TBE164813	1.000	14,97	TBE184813	500	17,15	TBE254813	250	22,40	
4,8x16	TBE144816	1.000	8,19	TBE164816	1.000	7,78	TBE184816	500	17,37	TBE254816	250	22,68	
4,8x19	TBE144819	1.000	7,63	TBE164819	1.000	8,25	TBE184819	500	8,72	TBE254819	250	23,13	
4,8x25	TBE144825	1.000	9,26	TBE164825	1.000	9,37	TBE184825	500	10,54	TBE254825	250	23,91	
4,8x32	TBE144832	1.000	12,09	TBE164832	1.000	10,68	TBE184832	500	19,72	TBE254832	250	25,03	
4,8x38	TBE144838	1.000	14,12	TBE164838	500	11,61	TBE184838	500	12,77	TBE254838	250	25,92	
4,8x50	TBE144850	500	21,67	TBE164850	500	21,84	TBE184850	500	23,63	TBE254850	250	27,26	
4,8x60	TBE144860	500	24,13	TBE164860	250	24,24	TBE184860	250	26,03	TBE254860	125	30,95	
4,8x70	TBE144870	250	26,42	TBE164870	250	26,53	TBE184870	250	28,38	TBE254870	125	32,85	
5,5x19	TBE145519	1.000	17,26	TBE165519	1.000	8,71	TBE185519	500	19,55	TBE255519	250	24,86	
5,5x22	TBE145522	1.000	9,73	TBE165522	1.000	9,20	TBE185522	500	11,53	TBE255522	250	15,23	
5,5x25	TBE145525	1.000	18,60	TBE165525	1.000	11,19	TBE185525	500	12,79	TBE255525	250	19,57	
5,5x32	TBE145532	1.000	10,69	TBE165532	1.000	11,95	TBE185532	500	16,22	TBE255532	250	27,65	
5,5x38	TBE145538	1.000	21,62	TBE165538	500	13,65	TBE185538	500	17,18	TBE255538	250	28,77	
5,5x50	TBE145550	500	25,19	TBE165550	500	15,50	TBE185550	500	19,79	TBE255550	250	32,73	
5,5x63	TBE145563	500	29,05	TBE165563	250	18,49	TBE185563	250	20,47	TBE255563	125	37,82	
5,5x75	TBE145575	250	32,06	TBE165575	250	22,70	TBE185575	250	35,02	TBE255575	125	40,44	
6,3x19	TBE146319	1.000	21,28	TBE166319	1.000	13,59	TBE186319	500	15,92	TBE256319	250	28,71	
6,3x25	TBE146325	1.000	23,41	TBE166325	500	13,85	TBE186325	500	16,14	TBE256325	250	21,87	
6,3x32	TBE146332	500	25,25	TBE166332	500	16,50	TBE186332	500	19,21	TBE256332	250	24,14	
6,3x38	TBE146338	500	26,81	TBE166338	500	17,59	TBE186338	500	20,43	TBE256338	250	25,78	
6,3x50	TBE146350	500	31,11	TBE166350	250	20,26	TBE186350	250	22,91	TBE256350	125	30,24	
6,3x63	TBE146363	250	35,97	TBE166363	250	25,24	TBE186363	250	26,54	TBE256363	125	30,69	
6,3x75	TBE146375	250	39,55	TBE166375	250	27,87	TBE186375	250	29,72	TBE256375	125	47,93	
6,3x80	TBE146380	250	43,46	TBE166380	100	33,17	TBE186380	100	34,95	TBE256380	100	39,88	
6,3x90	TBE146390	250	47,93	TBE166390	100	38,68	TBE186390	100	37,27	TBE256390	100	42,47	
6,3x100	TBE146310	100	53,57	TBE166310	100	40,38	TBE186310	100	40,84	TBE256310	100	45,89	
6,3x110	TBE146311	100	62,28	TBE166311	100	46,11	TBE186311	100	48,44	TBE256311	100	50,12	
6,3x120	TBE146312	100	68,21	TBE166312	100	53,03	TBE186312	100	56,01	TBE256312	100	57,95	
6,3x130	TBE146313	100	86,47	TBE166313	100	58,37	TBE186313	100	67,58	TBE256313	100	63,53	
6,3x140	TBE146314	100	92,67	TBE166314	100	64,77	TBE186314	100	70,57	TBE256314	100	69,48	
6,3x150	TBE146315	100	100,66	TBE166315	100	94,52	TBE186315	100	102,67	TBE256315	100	107,31	
6,3x160	TBE146316	100	110,94	TBE166316	100	107,31	TBE186316	100	100,60	TBE256316	100	117,59	
6,3x180	TBE146318	100	142,28	TBE166318	100	134,51	TBE186318	100	144,23	TBE256318	100	148,98	
6,3x200	TBE146320	100	156,13	TBE166320	100	146,91	TBE186320	100	158,08	TBE256320	100	162,78	
6,3x220	TBE146322	100	175,85	TBE166322	100	164,56	TBE186322	100	177,80	TBE256322	100	182,49	
6,3x240	TBE146324	100	197,41	TBE166324	100	186,80	TBE186324	100	199,42	TBE256324	100	204,06	



AR-NE

ARANDELA de estanqueidad vulcanizada
ACERO PREGALVANIZADO - EPDM

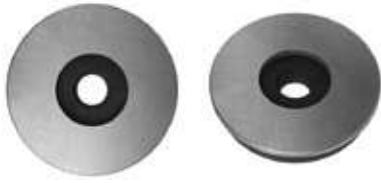

PREGALVANIZADA / EPDM NEGRO

CÓDIGO CODE	MEDIDA SIZE	Ø EXT - Ø INT (Ø INT EPDM)			€/ 100
TARNEZ14	Ø 14	Ø 14 - Ø 6,7 (Ø 2,0 EPDM)	1.000	12.000	4,07
TARNEZ16	Ø 16	Ø 16 - Ø 7,0 (Ø 2,5 EPDM)	1.000	6.000	4,66
TARNEZ18	Ø 18	Ø 18 - Ø 7,0 (Ø 3,5 EPDM)	1.000	6.000	6,12
TARNEZ25	Ø 25	Ø 25 - Ø 7,0 (Ø 3,5 EPDM)	500	3.000	10,44

INOX (A2)



INOXIDABLE A2 / EPDM NEGRO

CÓDIGO CODE	MEDIDA SIZE	Ø EXT - Ø INT (Ø INT EPDM)			€/ 100
TARNEI14	Ø 14	Ø 14 - Ø 6,7 (Ø 2,0 EPDM)	1.000	12.000	11,36
TARNEI16	Ø 16	Ø 16 - Ø 7,0 (Ø 2,5 EPDM)	1.000	6.000	12,84
TARNEI18	Ø 18	Ø 18 - Ø 7,0 (Ø 3,5 EPDM)	1.000	6.000	16,16
TARNEI25	Ø 25	Ø 25 - Ø 7,0 (Ø 3,5 EPDM)	500	3.000	29,87
TARNEI30	Ø 30	Ø 30 - Ø 7,0 (Ø 3,5 EPDM)	500	1.500	45,90



PREGALVANIZADA / EPDM GRIS

CÓDIGO CODE	MEDIDA SIZE	Ø EXT - Ø INT (Ø INT EPDM)			€/ 100
TARNEG14	Ø 14	Ø 14 - Ø 6,9 (Ø 2,0 EPDM)	1.000	12.000	4,32
TARNEG16	Ø 16	Ø 16 - Ø 6,9 (Ø 2,0 EPDM)	1.000	6.000	4,80
TARNEG18	Ø 18	Ø 18 - Ø 6,9 (Ø 3,0 EPDM)	1.000	6.000	6,62
TARNEG25	Ø 25	Ø 25 - Ø 6,9 (Ø 3,0 EPDM)	500	3.000	10,44

INOX (A2)



INOXIDABLE A2 / EPDM GRIS

CÓDIGO CODE	MEDIDA SIZE	Ø EXT - Ø INT (Ø INT EPDM)			€/ 100
TARNEGI14	Ø 14	Ø 14 - Ø 6,9 (Ø 2,0 EPDM)	1.000	12.000	11,82
TARNEGI16	Ø 16	Ø 16 - Ø 6,9 (Ø 2,0 EPDM)	1.000	6.000	13,38
TARNEGI18	Ø 18	Ø 18 - Ø 6,9 (Ø 3,0 EPDM)	1.000	6.000	16,80
TARNEGI25	Ø 25	Ø 25 - Ø 6,9 (Ø 3,0 EPDM)	500	3.000	31,08



INOX (A2)



ARANDELA CUELLO, INOXIDABLE A2

CÓDIGO CODE	MEDIDA SIZE	Ø EXT - Ø INT (Ø INT EPDM)			€/ 100
TARNEIC30	Ø 30	Ø 30 - Ø 9,4 (Ø 6,7 EPDM)	500	1.500	44,64

INOX (A2)



ARANDELA PARAGÚAS, INOXIDABLE A2

CÓDIGO CODE	MEDIDA SIZE	Ø EXT - Ø INT (Ø INT EPDM)			€/ 100
TARNEIPAR	Ø 25	Ø 25 - Ø 10 (Ø 6,7 EPDM)	250	750	45,41

TAPHEX

TAPÓN para tornillos, cabeza hexagonal,
en colores



POLIAMIDA 6.6

CÓDIGO CODE		COLOR COLOUR			€/ 100
TAHE08AR	8	RAL 1001 ARENA	1.000	2.000	7,40
TAHE08BP	8	RAL 9010 BLANCO PIRINEO	1.000	2.000	7,40
TAHE08NE	8	RAL 9005 NEGRO	1.000	2.000	7,40
TAHE08RJ	8	RAL 3011 ROJO TEJA	1.000	2.000	7,40
TAHE08VN	8	RAL 6028 VERDE NAVARRA	1.000	2.000	7,40
TAHE10AR	10	RAL 1001 ARENA	1.000	2.000	7,40
TAHE10BP	10	RAL 9010 BLANCO PIRINEO	1.000	2.000	7,40
TAHE10NE	10	RAL 9005 NEGRO	1.000	2.000	7,40
TAHE10RJ	10	RAL 3011 ROJO TEJA	1.000	2.000	7,40
TAHE10VN	10	RAL 6028 VERDE NAVARRA	1.000	2.000	7,40

SI SU COLOR NO ESTA AQUÍ, PREGÚNTENOS POR FAVOR

DIN-7504-K / TBE-INOX

Tornillo autotaladrante, CABEZA HEXAGONAL, arandela estampada
INOX A2 (AISI 304)



carpintería aluminio
aluminium windows

INOXIDABLE A2



CÓDIGO CODE	MEDIDA SIZE				€ / 100
TBEI4213	4,2x13	7	500	12.000	15,76
TBEI4216	4,2x16	7	500	12.000	17,68
TBEI4219	4,2x19	7	500	12.000	18,32
TBEI4813	4,8x13	8	250	6.000	22,29
TBEI4816	4,8x16	8	250	6.000	21,78
TBEI4819	4,8x19	8	250	6.000	23,57
TBEI4825	4,8x25	8	250	6.000	26,39
TBEI4832	4,8x32	8	250	6.000	31,38
TBEI4838	4,8x38	8	250	3.000	39,50
TBEI5519	5,5x19	8	250	6.000	32,54
TBEI5522	5,5x22	8	250	6.000	34,71
TBEI5525	5,5x25	8	250	6.000	36,89
TBEI5532	5,5x32	8	250	3.000	41,79
TBEI5538	5,5x38	8	250	3.000	46,32
TBEI6319	6,3x19	10	250	6.000	49,31
TBEI6325	6,3x25	10	250	3.000	56,10
TBEI6332	6,3x32	10	250	3.000	67,34
TBEI6338	6,3x38	10	250	3.000	73,94
TBEI6315	6,3x150	10	100	400	300,44

DIN-7504-K / TRE

Tornillo autotaladrante, CABEZA HEXAGONAL 8 mm, arandela estampada, **PUNTA REDUCIDA N° 1**



ensamblaje de chapas
montagem de chapa

perfiles de chapa
perfis de chapa



SOLICITAR
FICHA TÉCNICA

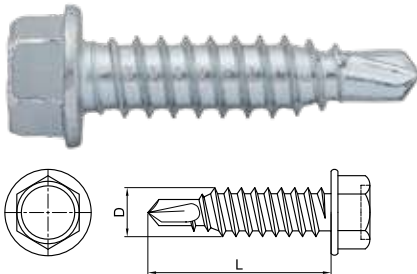

ZINCADO

CÓDIGO CODE	MEDIDA SIZE		CAP.	MAX.			€ / 100
TRE4816	4,8x16	8	1,00 Max.	8,00	500	6.000	5,39
TRE4819	4,8x19	8	1,00 Max.	11,00	500	6.000	5,66
TRE5522	5,5x22	8	1,50 Max.	12,00	500	4.000	8,13
TRE6320	6,3x20	8	1,50 Max.	9,00	500	3.000	8,91
TRE6325	6,3x25	8	1,50 Max.	14,00	500	3.000	10,59
TRE6332	6,3x32	8	1,50 Max.	21,00	500	3.000	12,88
TRE6338	6,3x38	8	1,50 Max.	27,00	500	3.000	14,83
TRE6350	6,3x50	8	1,50 Max.	37,00	250	1.500	18,08
TRE6363	6,3x63	8	1,50 Max.	40,00	250	1.500	23,39
TRE6380	6,3x80	8	1,50 Max.	57,00	250	1.000	29,08

DIN-7504-K / TRE+ARNE

PUNTA REDUCIDA N°1
Con arandela de EPDM Ø16, montada



MONTADO ARANDELA P-16 / ZINCADO

CÓDIGO CODE	MEDIDA SIZE			€ / 100
TRE164816	4,8x16, Montado / Assembled P-16	500	3.000	14,06
TRE164819	4,8x19, Montado / Assembled P-16	500	3.000	14,71
TRE165522	5,5x22, Montado / Assembled P-16	500	3.000	14,79
TRE166320	6,3x20, Montado / Assembled P-16	500	3.000	15,27
TRE166325	6,3x25, Montado / Assembled P-16	500	3.000	16,68
TRE166332	6,3x32, Montado / Assembled P-16	500	2.000	22,68
TRE166338	6,3x38, Montado / Assembled P-16	500	2.000	23,53
TRE166350	6,3x50, Montado / Assembled P-16	250	1.000	27,86
TRE166363	6,3x63, Montado / Assembled P-16	250	1.500	33,92
TRE166380	6,3x80, Montado / Assembled P-16	250	1.500	44,16

TVI / VIGA

Tornillo autotaladrante, CABEZA HEXAGONAL
arandela estampada, para viga, PUNTA BROCA Nº 5



ensamblaje de chapas
metal panels

perfiles de chapa
metal elements

viga IPN
beam IPN



SOLICITAR
FICHA TÉCNICA

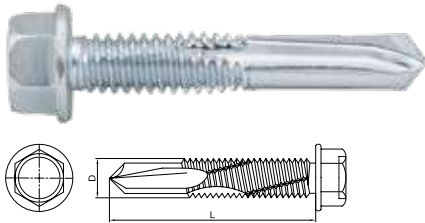

ZINCADO

CÓDIGO CODE	MEDIDA SIZE		CAP.	MAX.			€/ 100
TVI532	5,5x32	8	4,0 - 12,0	12,0 Max.	500	3.000	13,54
TVI538	5,5x38	8	4,0 - 12,0	12,0 Max.	500	3.000	14,80
TVI550	5,5x50	8	4,0 - 12,0	12,0 Max.	250	1.500	18,37
TVI560	5,5x60	8	4,0 - 12,0	12,0 Max.	250	1.500	21,11

TVI+ARNE

Con arandela de EPDM Ø16, montada



MONTADO ARANDELA P-16 / ZINCADO

CÓDIGO CODE	MEDIDA SIZE					€/ 100	
TVI16532	5,5x32, Montado / Assembled P-16				500	2.000	17,38
TVI16538	5,5x38, Montado / Assembled P-16				500	2.000	18,51
TVI16550	5,5x50, Montado / Assembled P-16				250	1.000	23,45
TVI16560	5,5x60, Montado / Assembled P-16				250	1.000	25,59

TRB

Tornillo autotaladrante, CABEZA ALOMADA BAJA,
arandela estampada



ensamblaje de chapas
metal panels

perfiles de chapa
metal elements

carpintería aluminio
aluminium windows



SOLICITAR
FICHA TÉCNICA

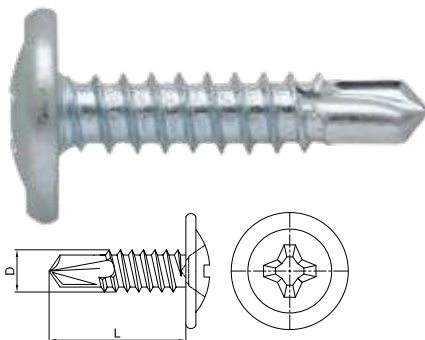

ZINCADO

CÓDIGO CODE	MEDIDA SIZE		CAP.	MAX.			€/ 100
TRBZ4213	4,2x13	PH2	0,75 - 2,50	Max. 4,3	500	12.000	3,84
TRBZ4216	4,2x16	PH2	0,75 - 2,50	Max. 7,3	500	8.000	4,24
TRBZ4219	4,2x19	PH2	0,75 - 2,50	Max.10,3	500	6.000	4,73
TRBZ4225	4,2x25	PH2	0,75 - 2,50	Max.16,3	500	6.000	4,99
TRBZ4232	4,2x32	PH2	0,75 - 2,50	Max.23,0	500	6.000	6,25

ZINCADO NEGRO

CÓDIGO CODE	MEDIDA SIZE		CAP.	MAX.			€/ 100
TRBN4213	4,2x13	PH2	0,75 - 2,50	Max. 4,3	500	12.000	5,91
TRBN4216	4,2x16	PH2	0,75 - 2,50	Max. 7,3	500	8.000	6,65
TRBN4219	4,2x19	PH2	0,75 - 2,50	Max. 10,3	500	6.000	7,38
TRBN4225	4,2x25	PH2	0,75 - 2,50	Max. 16,3	500	6.000	8,50
TRBN4232	4,2x32	PH2	0,75 - 2,50	Max. 23,0	500	6.000	10,04

CABEZA LACADA BLANCO

NEW	CÓDIGO CODE	MEDIDA SIZE		CAP.	MAX.			€/ 100
	TRBL4213	4,2x13	PH2	0,75 - 2,50	Max. 4,3	500	12.000	6,97
	TRBL4216	4,2x16	PH2	0,75 - 2,50	Max. 7,3	500	8.000	7,56
	TRBL4219	4,2x19	PH2	0,75 - 2,50	Max. 10,3	500	6.000	8,57
	TRBL4225	4,2x25	PH2	0,75 - 2,50	Max. 16,3	500	6.000	10,38
	TRBL4232	4,2x32	PH2	0,75 - 2,50	Max. 23,0	500	6.000	11,55

PINTADO BLANCO

NEW	CÓDIGO CODE	MEDIDA SIZE		CAP.	MAX.			€/ 100
	TRBP4213	4,2x13	PH2	0,75 - 2,50	Max. 4,3	500	12.000	11,82
	TRBP4216	4,2x16	PH2	0,75 - 2,50	Max. 7,3	500	8.000	12,12
	TRBP4219	4,2x19	PH2	0,75 - 2,50	Max. 10,3	500	6.000	12,79
	TRBP4225	4,2x25	PH2	0,75 - 2,50	Max. 16,3	500	6.000	16,65
	TRBP4232	4,2x32	PH2	0,75 - 2,50	Max. 23,0	500	6.000	16,68

TBI BIMETAL

Tornillo autotaladrante, CABEZA HEXAGONAL, arandela estampada, **INOX A2 BIMETAL**

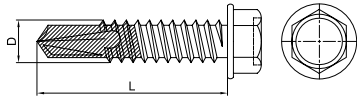

BIMETAL

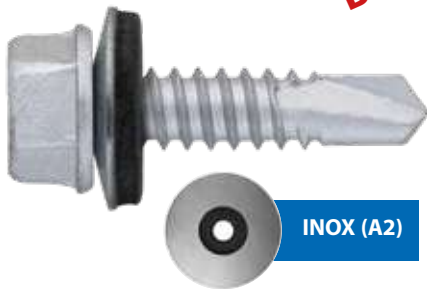

ensamblaje de chapas
metal panels

perfiles de chapa
metal elements



SOLICITAR
FICHA TÉCNICA

ACABADO : SILVER RUSPERT

CÓDIGO CODE	MEDIDA SIZE	Ø	CAP.	MAX.	500	3.000	€/ 100
TBI4825	4,8x 25	8	4,40 Max.	14,70	500	6.000	65,85
TBI5525	5,5x 25	8	5,25 Max.	14,70	500	6.000	77,19
TBI5532	5,5x 32	8	5,25 Max.	21,50	500	3.000	88,65
TBI5538	5,5x 38	8	5,25 Max.	27,50	500	3.000	94,25
TBI5550	5,5x 50	8	5,25 Max.	39,50	500	2.000	108,79
TBI5558	5,5x 58	8	5,25 Max.	47,50	250	1.500	121,08
TBI5565	5,5x 65	8	5,25 Max.	54,50	250	1.500	126,56
TBI5580	5,5x 80	8	5,25 Max.	69,50	250	1.000	149,31
TBI6325	6,3x 25	10	6,00 Max.	13,00	500	3.000	98,84

MONTADO ARANDELA P-16 INOXIDABLE A2

CÓDIGO CODE	MEDIDA SIZE	500	3.000	€/ 100
TBI164825	4,8x25, Montado / Assembled P-16	500	2.000	78,98
TBI165525	5,5x25, Montado / Assembled P-16	500	3.000	91,50
TBI165532	5,5x32, Montado / Assembled P-16	500	2.000	104,10
TBI165538	5,5x38, Montado / Assembled P-16	500	1.500	109,49
TBI165550	5,5x50, Montado / Assembled P-16	500	1.500	127,71
TBI165558	5,5x58, Montado / Assembled P-16	250	1.500	137,41
TBI165565	5,5x65, Montado / Assembled P-16	250	1.500	143,00
TBI165580	5,5x80, Montado / Assembled P-16	250	1.000	166,41
TBI166325	6,3x25, Montado / Assembled P-16	500	2.000	114,32

TRBI BIMETAL

Tornillo autotaladrante, CABEZA HEXAGONAL, arandela estampada, **PUNTA REDUCIDA N°1**, **INOX A2 BIMETAL**



BIMETAL



ACABADO : SILVER RUSPERT

CÓDIGO CODE	MEDIDA SIZE	Ø	CAP.	MAX.	500	3.000	€/ 100
TRBI6325	6,3x 25	8	1,00 Max.	14,00	500	3.000	115,50

MONTADO ARANDELA P-16 INOXIDABLE A2

CÓDIGO CODE	MEDIDA SIZE	500	2.000	€/ 100
TRBI166325	6,3x25, Montado / Assembled P-16	500	2.000	129,80

TVIB-VIGA BIMETAL

Tornillo autotaladrante, CABEZA HEXAGONAL, arandela estampada, para viga, **PUNTA BROCA N°5**, **INOX A2 BIMETAL**



BIMETAL

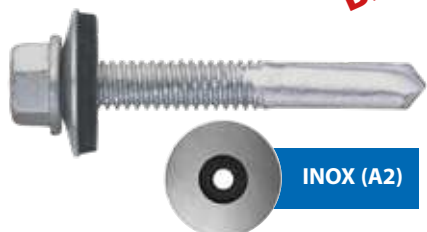

ensamblaje de chapas
metal panels

perfiles de chapa
metal elements

viga IPN
beam IPN

ACABADO: SILVER RUSPERT

CÓDIGO CODE	MEDIDA SIZE	Ø	CAP.	MAX.	500	3.000	€/ 100
TVIB5540	5,5x 40	8	4,0 - 12,0	12,0 Max.	500	3.000	112,68
TVIB5550	5,5x 50	8	4,0 - 12,0	12,0 Max.	500	3.000	151,80
TVIB5565	5,5x 65	8	4,0 - 12,0	12,0 Max.	250	1.500	158,58
TVIB5580	5,5x 80	8	4,0 - 12,0	12,0 Max.	250	1.000	203,53
TVIB5510	5,5x100	8	4,0 - 12,0	12,0 Max.	100	600	205,81

MONTADO ARANDELA P-16 INOXIDABLE A2

CÓDIGO CODE	MEDIDA SIZE	500	2.000	€/ 100
TVIB165540	5,5x40, Montado / Assembled P-16	500	2.000	133,56
TVIB165550	5,5x50, Montado / Assembled P-16	500	1.500	175,02
TVIB165565	5,5x65, Montado / Assembled P-16	250	1.000	180,84
TVIB165580	5,5x80, Montado / Assembled P-16	250	1.000	212,55
TVIB165510	5,5x100, Montado / Assembled P-16	100	600	226,45

TS3

Tornillo autotaladrante, CABEZA HEXAGONAL, arandela estampada, con dos roscas, para **PANEL SANDWICH, PUNTA BROCA N° 3**

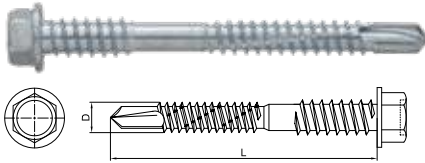

ZINCADO

CÓDIGO CODE	MEDIDA SIZE		CAP.	MAX.			€/ 100
TS355060	5,5 / 6,3x60	8	1,5 - 6,0	27 - 44	500	1.500	17,26
TS355082	5,5 / 6,3x82	8	1,5 - 6,0	31 - 68	250	1.000	20,88
TS355098	5,5 / 6,3x98	8	1,5 - 6,0	48 - 84	250	1.000	23,84
TS355115	5,5 / 6,3 x115	8	1,5 - 6,0	63 -100	250	1.000	32,70
TS355130	5,5 / 6,3 x130	8	1,5 - 6,0	65 -115	250	750	39,37
TS355150	5,5 / 6,3 x150	8	1,5 - 6,0	85 -135	250	750	47,34
TS355180	5,5 / 6,3 x180	8	1,5 - 6,0	115 -165	250	750	79,24
TS355200	5,5 / 6,3 x200	8	1,5 - 6,0	135 -185	250	750	84,00
TS355230	5,5 / 6,3 x230	8	1,5 - 6,0	165 -215	250	500	97,00

TS3+ARNE

Con arandela de EPDM Ø16, montada



MONTADO ARANDELA P-16 / ZINCADO

CÓDIGO CODE	MEDIDA SIZE					€/ 100	
TS31655060	5,5 / 6,3x60, Montado/Assembled P-16				250	1.000	23,63
TS31655082	5,5 / 6,3x82, Montado/Assembled P-16				250	1.000	26,40
TS31655098	5,5 / 6,3x98, Montado/Assembled P-16				250	750	30,25
TS31655115	5,5 / 6,3 x115, Montado/Assembled P-16				-	500	36,66
TS31655130	5,5 / 6,3 x130, Montado/Assembled P-16				250	750	49,73
TS31655150	5,5 / 6,3 x150, Montado/Assembled P-16				250	500	57,13
TS31655180	5,5 / 6,3 x180, Montado/Assembled P-16				125	375	93,40
TS31655200	5,5 / 6,3 x200, Montado/Assembled P-16				125	375	94,00
TS31655230	5,5 / 6,3 x230, Montado/Assembled P-16				125	250	107,00

TS5

Tornillo autotaladrante, CABEZA HEXAGONAL, arandela estampada, con dos roscas, para **PANEL SANDWICH, PUNTA BROCA N° 5**

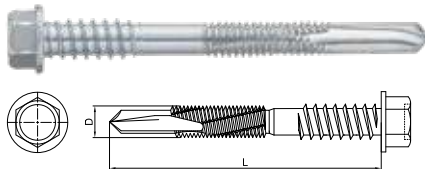
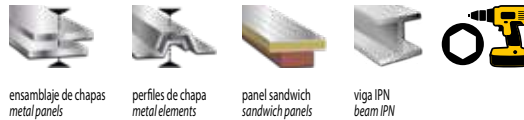

ZINCADO

CÓDIGO CODE	MEDIDA SIZE		CAP.	MAX.			€/ 100
TS555075	5,5 / 6,3x75	8	4,0 - 12,0	27 - 45	500	1.500	19,93
TS555085	5,5 / 6,3x85	8	4,0 - 12,0	31 - 55	250	1.000	22,17
TS555105	5,5 / 6,3 x105	8	4,0 - 12,0	48 - 75	250	1.000	29,32
TS555130	5,5 / 6,3 x130	8	4,0 - 12,0	63 -100	250	750	42,20
TS555150	5,5 / 6,3 x150	8	4,0 - 12,0	63 -120	250	750	55,66
TS555175	5,5 / 6,3 x175	8	4,0 - 12,0	110 -160	250	750	79,20
TS555180	5,5 / 6,3 x180	8	4,0 - 12,0	115 -165	250	750	84,00
TS555200	5,5 / 6,3 x200	8	4,0 - 12,0	135 -185	250	750	101,37
TS555230	5,5 / 6,3 x230	8	4,0 - 12,0	165 -215	250	500	174,15
TS555240	5,5 / 6,3 x240	8	4,0 - 12,0	175 -225	250	500	220,00

TS5+ARNE

Con arandela de EPDM Ø16, montada



MONTADO ARANDELA P-16 / ZINCADO

CÓDIGO CODE	MEDIDA SIZE					€/ 100	
TS51655075	5,5 / 6,3x75, Montado/Assembled P-16				250	1.000	27,30
TS51655085	5,5 / 6,3x85, Montado/Assembled P-16				250	1.000	30,55
TS51655105	5,5 / 6,3 x105, Montado/Assembled P-16				250	750	37,97
TS51655130	5,5 / 6,3 x130, Montado/Assembled P-16				250	750	51,15
TS51655150	5,5 / 6,3 x150, Montado/Assembled P-16				250	500	64,61
TS51655175	5,5 / 6,3 x175, Montado/Assembled P-16				125	375	106,22
TS51655180	5,5 / 6,3 x180, Montado/Assembled P-16				125	375	112,00
TS51655200	5,5 / 6,3 x200, Montado/Assembled P-16				125	375	115,28
TS51655230	5,5 / 6,3 x230, Montado/Assembled P-16				125	250	193,59
TS51655240	5,5 / 6,3 x240, Montado/Assembled P-16				125	250	237,00

TFI

Tornillo autotaladrante, CABEZA HEXAGONAL, arandela estampada, para **FIBROCEMENTO**, montado con arandela paraguas, INOX

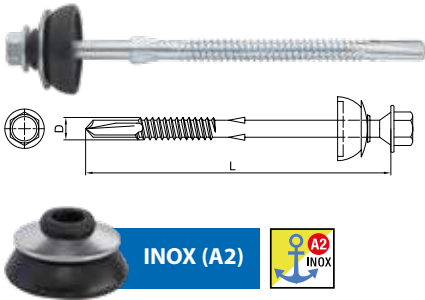
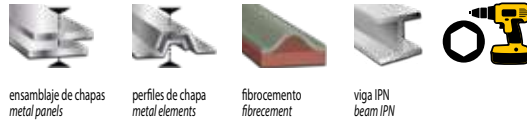

ZINCADO

CÓDIGO CODE	MEDIDA SIZE		BROCA Nº	CAP.	MAX.		€/ 100
TFI63115	6,3x115 / # 3	8	3	1,5 - 6,0	85	250	89,23
TFI63125	6,3x125 / # 3	8	3	1,5 - 6,0	95	250	91,00
TFI63110	6,3x110 / # 5	8	5	6,0 - 12,0	75	250	88,87
TFI63120	6,3x120 / # 5	8	5	6,0 - 12,0	85	250	90,47
TFI63130	6,3x130 / # 5	8	5	6,0 - 12,0	95	250	96,64
TFI63150	6,3x150 / # 5	8	5	6,0 - 12,0	115	250	101,36
TFI63160	6,3x160 / # 5	8	5	6,0 - 12,0	125	250	119,32

TABA, PHILLIPS

Tornillo autotaladrante, CABEZA AVELLANADA, 2 alas, huella Phillips



ZINCADO

CÓDIGO CODE	MEDIDA SIZE		CAP.	MAX.		€/ 100	
TABA4832	4,8x32	PH2	1,75 - 4,00	14,00	500	6.000	6,03
TABA4838	4,8x38	PH2	1,75 - 4,00	20,00	500	6.000	6,06
TABA4845	4,8x45	PH2	1,75 - 4,00	27,00	500	3.000	8,06
TABA4850	4,8x50	PH2	1,75 - 4,00	32,00	500	3.000	8,03
TABA5538	5,5x38	PH2	1,75 - 5,00	17,00	500	3.000	8,94
TABA5545	5,5x45	PH2	1,75 - 5,00	24,00	500	3.000	9,55
TABA5555	5,5x55	PH2	1,75 - 5,00	34,00	500	3.000	11,94
TABA5565	5,5x65	PH2	1,75 - 5,00	44,00	500	2.000	13,19
TABA6360	6,3x60	PH2	2,50 - 6,00	38,00	250	1.500	17,22
TABA6370	6,3x70	PH2	2,50 - 6,00	48,00	250	1.500	20,86
TABA6385	6,3x85	PH2	2,50 - 6,00	61,00	250	1.000	24,69

TABA, TORX

Tornillo autotaladrante, CABEZA AVELLANADA, 2 alas, huella TORX



ZINCADO

CÓDIGO CODE	MEDIDA SIZE		CAP.	MAX.		€/ 100	
TABATX4832	4,8x32	TORX 25	1,75 - 4,00	14,00	500	6.000	5,55
TABATX4838	4,8x38	TORX 25	1,75 - 4,00	20,00	500	6.000	6,43
TABATX4845	4,8x45	TORX 25	1,75 - 4,00	27,00	500	3.000	8,16
TABATX4850	4,8x50	TORX 25	1,75 - 4,00	32,00	500	3.000	8,65
TABATX5538	5,5x38	TORX 25	1,75 - 5,00	17,00	500	3.000	9,63
TABATX5545	5,5x45	TORX 25	1,75 - 5,00	24,00	500	3.000	10,03
TABATX5555	5,5x55	TORX 25	1,75 - 5,00	34,00	500	3.000	11,70
TABATX5565	5,5x65	TORX 25	1,75 - 5,00	44,00	500	2.000	14,53
TABATX6360	6,3x60	TORX 30	2,50 - 6,00	38,00	250	1.500	18,56
TABATX6370	6,3x70	TORX 30	2,50 - 6,00	48,00	250	1.500	21,13
TABATX6385	6,3x85	TORX 30	2,50 - 6,00	61,00	250	1.000	25,92
TABATX63100	6,3x100	TORX 30	2,50 - 6,00	76,00	250	750	37,35

TBCE

Tornillo autotaladrante, **CABEZA EXTRAPLANA**



ensamblaje de chapas metal panels perfiles de chapa metal elements carpintería aluminio aluminium windows



DISPONIBLE EN COLORES RAL



SOLICITAR FICHA TÉCNICA

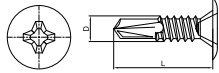

ZINCADO

CÓDIGO CODE	MEDIDA SIZE	+	CAP.	↓ MAX.			€/ 100
TBCEZ4214	4,2x14	PH2	2,00 Max.	6,00	500	22.500	2,40
TBCEZ4223	4,2x23	PH2	2,00 Max.	15,00	500	12.000	3,55

ZINCADO NEGRO

CÓDIGO CODE	MEDIDA SIZE	+	CAP.	↓ MAX.			€/ 100
TBCEN4214	4,2x14	PH2	2,00 Max.	6,00	500	22.500	3,44
TBCEN4223	4,2x23	PH2	2,00 Max.	15,00	500	12.000	5,13

PINTADO BLANCO

CÓDIGO CODE	MEDIDA SIZE	+	CAP.	↓ MAX.			€/ 100
TBCEP4214	4,2x14	PH2	2,00 Max.	6,00	500	22.500	5,07
TBCEP4223	4,2x23	PH2	2,00 Max.	15,00	500	12.000	7,47

CABEZA LACADA BLANCO



CÓDIGO CODE	MEDIDA SIZE	+	CAP.	↓ MAX.			€/ 100
TBCEL4214	4,2x14	PH2	2,00 Max.	6,00	500	22.500	9,33
TBCEL4223	4,2x23	PH2	2,00 Max.	15,00	500	12.000	11,96

INOXIDABLE A2

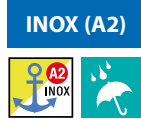

CÓDIGO CODE	MEDIDA SIZE	+	CAP.	↓ MAX.			€/ 100
TBCEI4214	4,2x14	PH2	2,00 Max.	6,00	500	22.500	19,31
TBCEI4223	4,2x23	PH2	2,00 Max.	15,00	500	12.000	26,65

TACE

Tornillo autorroscante, **CABEZA EXTRAPLANA**



ensamblaje de chapas metal panels perfiles de chapa metal elements carpintería aluminio aluminium windows



DISPONIBLE EN COLORES RAL



SOLICITAR FICHA TÉCNICA

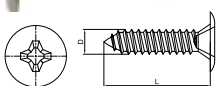

ZINCADO

CÓDIGO CODE	MEDIDA SIZE	+	BROCA Ø	↓ MAX.			€/ 100
TACEZ4213	4,2x13	PH2	3,20 - 3,90	8,00	500	12.000	2,42
TACEZ4222	4,2x22	PH2	3,20 - 3,90	17,00	500	12.000	3,47
TACEZ4232	4,2x32	PH2	3,20 - 3,90	27,00	500	6.000	4,63

ZINCADO NEGRO

CÓDIGO CODE	MEDIDA SIZE	+	BROCA Ø	↓ MAX.			€/ 100
TACEN4213	4,2x13	PH2	3,20 - 3,90	8,00	500	12.000	3,52
TACEN4222	4,2x22	PH2	3,20 - 3,90	17,00	500	12.000	5,14
TACEN4232	4,2x32	PH2	3,20 - 3,90	27,00	500	6.000	7,20

PINTADO BLANCO

CÓDIGO CODE	MEDIDA SIZE	+	BROCA Ø	↓ MAX.			€/ 100
TACEP4213	4,2x13	PH2	3,20 - 3,90	8,00	500	12.000	4,85
TACEP4222	4,2x22	PH2	3,20 - 3,90	17,00	500	12.000	7,18
TACEP4232	4,2x32	PH2	3,20 - 3,90	27,00	500	6.000	9,82

INOXIDABLE A2



CÓDIGO CODE	MEDIDA SIZE	+	BROCA Ø	↓ MAX.			€/ 100
TACEI4213	4,2x13	PH2	3,20 - 3,90	8,00	500	12.000	8,68
TACEI4222	4,2x22	PH2	3,20 - 3,90	17,00	500	12.000	14,90
TACEI4232	4,2x32	PH2	3,20 - 3,90	27,00	500	6.000	18,17

DIN-7504-N / TBR

Tornillo autotaladrante, **CABEZA ALOMADA**, Phillips



ensamblaje de chapas
metal panels

perfiles de chapa
metal elements

carpintería aluminio
aluminium windows



PUNTAS
DISPONIBLE, VER PÁGINA:

P. 132



DISPONIBLE EN
COLORES RAL



ZINCADO

CÓDIGO CODE	MEDIDA SIZE		CAR.	MAX.			€/ 100
TBRZ3509	3,5x9,5	PH2	2,25 Max.	3,35	1.000	24.000	1,55
TBRZ3511	3,5x11	PH2	2,25 Max.	4,85	1.000	24.000	1,83
TBRZ3513	3,5x13	PH2	2,25 Max.	6,85	1.000	24.000	1,85
TBRZ3516	3,5x16	PH2	2,25 Max.	9,85	1.000	16.000	2,01
TBRZ3519	3,5x19	PH2	2,25 Max.	12,85	1.000	12.000	2,21
TBRZ3522	3,5x22	PH2	2,25 Max.	15,85	1.000	12.000	2,47
TBRZ3525	3,5x25	PH2	2,25 Max.	18,85	500	12.000	2,84
TBRZ3532	3,5x32	PH2	2,25 Max.	25,85	500	6.000	3,26
TBRZ3913	3,9x13	PH2	2,40 Max.	6,70	1.000	16.000	2,21
TBRZ3916	3,9x16	PH2	2,40 Max.	9,70	1.000	12.000	2,42
TBRZ3919	3,9x19	PH2	2,40 Max.	12,70	1.000	12.000	2,69
TBRZ3925	3,9x25	PH2	2,40 Max.	18,70	500	8.000	3,20
TBRZ3932	3,9x32	PH2	2,40 Max.	25,70	500	6.000	3,94
TBRZ4213	4,2x13	PH2	3,00 Max.	5,80	1.000	12.000	2,37
TBRZ4216	4,2x16	PH2	3,00 Max.	8,80	1.000	12.000	2,62
TBRZ4219	4,2x19	PH2	3,00 Max.	11,80	1.000	12.000	2,91
TBRZ4222	4,2x22	PH2	3,00 Max.	14,80	500	8.000	3,44
TBRZ4225	4,2x25	PH2	3,00 Max.	17,80	500	6.000	3,58
TBRZ4232	4,2x32	PH2	3,00 Max.	24,80	500	6.000	4,28
TBRZ4238	4,2x38	PH2	3,00 Max.	30,80	500	6.000	4,83
TBRZ4250	4,2x50	PH2	3,00 Max.	42,80	500	3.000	6,79
TBRZ4813	4,8x13	PH2	4,40 Max.	5,80	1.000	8.000	3,52
TBRZ4816	4,8x16	PH2	4,40 Max.	6,80	1.000	8.000	3,56
TBRZ4819	4,8x19	PH2	4,40 Max.	9,80	1.000	8.000	3,93
TBRZ4822	4,8x22	PH2	4,40 Max.	12,80	500	6.000	4,71
TBRZ4825	4,8x25	PH2	4,40 Max.	15,80	500	6.000	4,74
TBRZ4832	4,8x32	PH2	4,40 Max.	22,80	500	6.000	5,42
TBRZ4838	4,8x38	PH2	4,40 Max.	28,80	500	3.000	6,37
TBRZ4845	4,8x45	PH2	4,40 Max.	35,80	500	3.000	7,28
TBRZ4850	4,8x50	PH2	4,40 Max.	40,80	500	3.000	8,18
TBRZ4860	4,8x60	PH2	4,40 Max.	50,80	500	2.000	10,23
TBRZ4870	4,8x70	PH2	4,40 Max.	60,80	250	1.500	12,51
TBRZ4880	4,8x80	PH2	4,40 Max.	70,80	250	1.500	13,36
TBRZ4890	4,8x90	PH2	4,40 Max.	80,80	100	1.200	19,04
TBRZ4810	4,8x100	PH2	4,40 Max.	90,80	100	1.200	21,92
TBRZ4811	4,8x110	PH2	4,40 Max.	100,80	100	1.200	22,67
TBRZ4812	4,8x120	PH2	4,40 Max.	110,80	100	600	25,89
TBRZ5519	5,5x19	PH3	5,25 Max.	8,35	500	6.000	5,43
TBRZ5522	5,5x22	PH3	5,25 Max.	11,35	500	6.000	6,11
TBRZ5525	5,5x25	PH3	5,25 Max.	14,35	500	4.000	6,86
TBRZ5532	5,5x32	PH3	5,25 Max.	21,35	500	3.000	7,59
TBRZ5538	5,5x38	PH3	5,25 Max.	27,35	500	3.000	8,44
TBRZ5545	5,5x45	PH3	5,25 Max.	34,35	500	3.000	10,00
TBRZ5560	5,5x60	PH3	5,25 Max.	49,35	250	1.500	12,98
TBRZ5573	5,5x73	PH3	5,25 Max.	62,35	250	1.500	14,27

ZINCADO NEGRO

TBRN3509	3,5x9,5	PH2	2,25 Max.	3,35	1.000	24.000	2,30
TBRN3513	3,5x13	PH2	2,25 Max.	6,85	1.000	24.000	2,78
TBRN3516	3,5x16	PH2	2,25 Max.	9,85	1.000	16.000	2,94
TBRN3519	3,5x19	PH2	2,25 Max.	12,85	1.000	12.000	3,14
TBRN4213	4,2x13	PH2	3,00 Max.	5,80	1.000	12.000	3,41
TBRN4216	4,2x16	PH2	3,00 Max.	8,80	1.000	12.000	3,77
TBRN4219	4,2x19	PH2	3,00 Max.	11,80	1.000	12.000	4,24
TBRN4225	4,2x25	PH2	3,00 Max.	17,80	500	6.000	5,22
TBRN4232	4,2x32	PH2	3,00 Max.	24,80	500	6.000	6,14
TBRN4238	4,2x38	PH2	3,00 Max.	30,80	500	6.000	7,13
TBRN4816	4,8x16	PH2	4,40 Max.	6,80	1.000	8.000	5,20
TBRN4819	4,8x19	PH2	4,40 Max.	9,80	1.000	8.000	5,99
TBRN4825	4,8x25	PH2	4,40 Max.	15,80	500	6.000	7,05
TBRN4832	4,8x32	PH2	4,40 Max.	22,80	500	6.000	8,40
TBRN4838	4,8x38	PH2	4,40 Max.	28,80	500	3.000	9,21
TBRN4845	4,8x45	PH2	4,40 Max.	35,80	500	3.000	10,69
TBRN4850	4,8x50	PH2	4,40 Max.	40,80	500	3.000	11,58

DIN-7504-N / TBRN

Zincado negro



DIN-7504-N / TBT, TX-OXBIT

Tornillo autotaladrante, CABEZA ALOMADA, TX-OXBIT



ensamblaje de chapas
metal panels

perfiles de chapa
metal elements

carpintería aluminio
aluminium windows



SOLICITAR
FICHA TÉCNICA



ZINCADO

CÓDIGO CODE	MEDIDA SIZE		CAP.	MAX.			€/ 100
TBTZ3509	3,5x9,5	OX15	2,25 Max.	3,35	1.000	24.000	1,79
TBTZ3513	3,5x13	OX15	2,25 Max.	6,85	1.000	24.000	2,11
TBTZ3516	3,5x16	OX15	2,25 Max.	9,85	1.000	16.000	2,35
TBTZ3519	3,5x19	OX15	2,25 Max.	12,85	1.000	12.000	2,58
TBTZ4213	4,2x13	OX20	3,00 Max.	5,80	1.000	12.000	2,70
TBTZ4216	4,2x16	OX20	3,00 Max.	8,80	1.000	12.000	3,02
TBTZ4219	4,2x19	OX20	3,00 Max.	11,80	1.000	12.000	3,39
TBTZ4225	4,2x25	OX20	3,00 Max.	17,80	500	6.000	4,12
TBTZ4816	4,8x16	OX25	4,40 Max.	6,80	1.000	8.000	4,17
TBTZ4819	4,8x19	OX25	4,40 Max.	9,80	1.000	8.000	4,52
TBTZ4825	4,8x25	OX25	4,40 Max.	15,80	500	6.000	5,51
TBTZ4832	4,8x32	OX25	4,40 Max.	22,80	500	6.000	6,30
TBTZ4838	4,8x38	OX25	4,40 Max.	28,80	500	3.000	7,46
TBTZ4845	4,8x45	OX25	4,40 Max.	35,80	500	3.000	8,59
TBTZ4850	4,8x50	OX25	4,40 Max.	40,80	500	3.000	9,41
TBTZ4860	4,8x60	OX25	4,40 Max.	50,80	500	2.000	11,76
TBTZ4870	4,8x70	OX25	4,40 Max.	60,80	250	1.500	14,10
NEW TBTZ4875	4,8x75	OX25	4,40 Max.	65,80	100	1.200	14,38
NEW TBTZ4890	4,8x90	OX25	4,40 Max.	80,80	100	1.200	21,89
NEW TBTZ4810	4,8x100	OX25	4,40 Max.	90,80	100	1.200	25,47
NEW TBTZ4812	4,8x120	OX25	4,40 Max.	110,80	100	1.200	30,35

DIN-7504-N / TBTN, TX-ORBIT

Zincado negro



DISPONIBLE EN
COLORES RAL



ZINCADO NEGRO

CÓDIGO CODE	MEDIDA SIZE		CAP.	MAX.			€/ 100
TBTN3509	3,5x9,5	OX15	2,25 Max.	3,35	1.000	24.000	2,49
TBTN3513	3,5x13	OX15	2,25 Max.	6,85	1.000	24.000	2,77
TBTN3516	3,5x16	OX15	2,25 Max.	9,85	1.000	16.000	3,04
TBTN3519	3,5x19	OX15	2,25 Max.	12,85	1.000	12.000	3,34
TBTN4213	4,2x13	OX20	3,00 Max.	5,80	1.000	12.000	3,70
TBTN4216	4,2x16	OX20	3,00 Max.	8,80	1.000	12.000	4,03
TBTN4219	4,2x19	OX20	3,00 Max.	11,80	1.000	12.000	4,40
TBTN4225	4,2x25	OX20	3,00 Max.	17,80	500	6.000	5,37
TBTN4816	4,8x16	OX25	4,40 Max.	6,80	1.000	8.000	5,31
TBTN4819	4,8x19	OX25	4,40 Max.	9,80	1.000	8.000	5,78
TBTN4825	4,8x25	OX25	4,40 Max.	15,80	500	6.000	6,95
TBTN4832	4,8x32	OX25	4,40 Max.	22,80	500	6.000	8,11
TBTN4838	4,8x38	OX25	4,40 Max.	28,80	500	3.000	9,23
TBTN4845	4,8x45	OX25	4,40 Max.	35,80	500	3.000	10,33
TBTN4850	4,8x50	OX25	4,40 Max.	40,80	500	3.000	11,12
TBTN4860	4,8x60	OX25	4,40 Max.	50,80	500	2.000	13,14
TBTN4870	4,8x70	OX25	4,40 Max.	60,80	250	1.500	14,95

TCR

TAPONES DE PVC, para cabezas de tornillos
DIN-7981 & DIN-7504-N



SOLICITAR
FICHA TÉCNICA

BLANCO

CÓDIGO CODE	MEDIDA SIZE			€/ 100
TCR42B	PARA / FOR Ø 4,2		1.000 12.000	3,70
TCR48B	PARA / FOR Ø 4,8		1.000 12.000	3,70
TCR55B	PARA / FOR Ø 5,5		1.000 6.000	3,70

NEGRO

CÓDIGO CODE	MEDIDA SIZE			€/ 100
TCR42N	PARA / FOR Ø 4,2		1.000 12.000	3,70
TCR48N	PARA / FOR Ø 4,8		1.000 12.000	3,70
TCR55N	PARA / FOR Ø 5,5		1.000 6.000	3,70

DIN-7504-N / TBR-INOX

Tornillo autotaladrante, CABEZA ALOMADA, Phillips,
INOX A2 (AISI 304)



carpintería aluminio
aluminium windows

INOXIDABLE A2

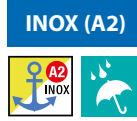

CÓDIGO CODE	MEDIDA SIZE				€ / 100
TBRI3509	3,5x9,5	PH2	500	22.500	9,85
TBRI3513	3,5x13	PH2	500	12.000	11,66
TBRI3916	3,9x16	PH2	500	12.000	13,90
TBRI3919	3,9x19	PH2	500	12.000	14,29
TBRI3925	3,9x25	PH2	250	6.000	18,00
TBRI4213	4,2x13	PH2	500	12.000	13,66
TBRI4216	4,2x16	PH2	500	12.000	15,31
TBRI4219	4,2x19	PH2	500	12.000	16,29
TBRI4225	4,2x25	PH2	250	6.000	17,74
TBRI4816	4,8x16	PH2	250	6.000	21,43
TBRI4819	4,8x19	PH2	250	6.000	21,77
TBRI4825	4,8x25	PH2	250	6.000	24,19
TBRI4832	4,8x32	PH2	250	6.000	28,31
TBRI4838	4,8x38	PH2	250	3.000	31,00
TBRI4850	4,8x50	PH2	250	3.000	36,55

DIN-7504-N / TBR-PINT

Tornillo autotaladrante, CABEZA ALOMADA, Phillips,
PINTADOS EN BLANCO



ensamblaje de chapas
metal panels

perfiles de chapa
metal elements

carpintería aluminio
aluminium windows



PINTADO BLANCO

CÓDIGO CODE	MEDIDA SIZE				€ / 100
TBRP3509	3,5x9,5	PH2	1.000	24.000	2,56
TBRP3513	3,5x13	PH2	1.000	24.000	4,34
TBRP3516	3,5x16	PH2	1.000	16.000	4,88
TBRP4213	4,2x13	PH2	1.000	12.000	5,67
TBRP4216	4,2x16	PH2	1.000	12.000	6,30
TBRP4219	4,2x19	PH2	1.000	12.000	6,32
TBRP4825	4,8x25	PH2	500	6.000	9,07

TPU

Puntas de atornillar,
POZIDRIV - PHILLIPS - TORX



PHILLIPS

CÓDIGO CODE	MEDIDA SIZE				€ / 100
TPUPHC01	Nº 1 / 25	PH1	25	1.200	66,19
TPUPHC02	Nº 2 / 25	PH2	25	1.200	66,19
TPUPHC03	Nº 3 / 25	PH3	25	1.200	66,19



PHILLIPS

CÓDIGO CODE	MEDIDA SIZE				€ / 100
TPUPHL01	Nº 1 / 50	PH1	25	1.200	106,18
TPUPHL02	Nº 2 / 50	PH2	25	1.200	106,18
TPUPHL03	Nº 3 / 50	PH3	25	1.200	106,18



POZIDRIV

CÓDIGO CODE	MEDIDA SIZE				€ / 100
TPUPOC01	Nº 1 / 25	PZ1	25	1.200	66,19
TPUPOC02	Nº 2 / 25	PZ2	25	1.200	66,19
TPUPOC03	Nº 3 / 25	PZ3	25	1.200	66,19



POZIDRIV

CÓDIGO CODE	MEDIDA SIZE				€ / 100
TPUPOL01	Nº 1 / 50	PZ1	25	1.200	106,18
TPUPOL02	Nº 2 / 50	PZ2	25	1.200	106,18
TPUPOL03	Nº 3 / 50	PZ3	25	1.200	106,18



TORX

CÓDIGO CODE	MEDIDA SIZE				€ / 100
TPUTOC08	Nº 8 / 25	T8	25	1.200	74,57
TPUTOC10	Nº 10 / 25	T10	25	1.200	74,57
TPUTOC15	Nº 15 / 25	T15	25	1.200	74,57
TPUTOC20	Nº 20 / 25	T20	25	1.200	74,57



TORX

CÓDIGO CODE	MEDIDA SIZE				€ / 100
TPUTOC25	Nº 25 / 25	T25	25	1.200	74,57
TPUTOC27	Nº 27 / 25	T27	25	1.200	74,57
TPUTOC30	Nº 30 / 25	T30	25	1.200	74,57
TPUTOC40	Nº 40 / 25	T40	25	1.200	74,57

DIN-7504-P / TBP

Tornillo autotaladrante, CABEZA AVELLANADA, Phillips

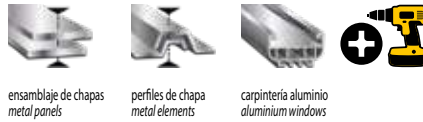

ensamblaje de chapas
metal panels

perfiles de chapa
metal elements

carpintería aluminio
aluminium windows



PUNTAS

DISPONIBLE, VER PÁGINA:

P. 132



DISPONIBLE EN
COLORES RAL



ZINCADO

CÓDIGO CODE	MEDIDA SIZE		CAP.	MAX.			€/ 100
TBPZ3509	3,5x9,5	PH2	2,25 Max.	2,85	1.000	24.000	1,94
TBPZ3511	3,5x11	PH2	2,25 Max.	4,85	1.000	24.000	1,62
TBPZ3513	3,5x13	PH2	2,25 Max.	6,85	1.000	24.000	1,69
TBPZ3516	3,5x16	PH2	2,25 Max.	9,85	1.000	24.000	1,80
TBPZ3519	3,5x19	PH2	2,25 Max.	12,85	1.000	12.000	2,02
TBPZ3522	3,5x22	PH2	2,25 Max.	15,85	1.000	12.000	2,36
TBPZ3525	3,5x25	PH2	2,25 Max.	18,85	500	12.000	2,49
TBPZ3913	3,9x13	PH2	2,40 Max.	6,70	1.000	24.000	1,87
TBPZ3916	3,9x16	PH2	2,40 Max.	9,70	1.000	12.000	2,14
TBPZ3919	3,9x19	PH2	2,40 Max.	12,70	1.000	12.000	2,40
TBPZ3922	3,9x22	PH2	2,40 Max.	15,70	500	12.000	2,72
TBPZ3925	3,9x25	PH2	2,40 Max.	18,70	500	12.000	2,78
TBPZ3932	3,9x32	PH2	2,40 Max.	25,70	500	6.000	3,35
TBPZ3938	3,9x38	PH2	2,40 Max.	31,70	500	6.000	3,90
TBPZ4213	4,2x13	PH2	3,00 Max.	5,80	1.000	24.000	2,18
TBPZ4216	4,2x16	PH2	3,00 Max.	8,80	1.000	12.000	2,36
TBPZ4219	4,2x19	PH2	3,00 Max.	11,80	1.000	12.000	2,68
TBPZ4222	4,2x22	PH2	3,00 Max.	14,80	500	12.000	3,02
TBPZ4225	4,2x25	PH2	3,00 Max.	17,80	500	6.000	3,29
TBPZ4232	4,2x32	PH2	3,00 Max.	24,80	500	6.000	3,77
TBPZ4238	4,2x38	PH2	3,00 Max.	30,80	500	6.000	4,51
TBPZ4813	4,8x13	PH2	4,40 Max.	3,80	1.000	12.000	3,05
TBPZ4816	4,8x16	PH2	4,40 Max.	6,80	1.000	12.000	3,22
TBPZ4819	4,8x19	PH2	4,40 Max.	9,80	1.000	8.000	3,67
TBPZ4822	4,8x22	PH2	4,40 Max.	12,80	500	6.000	4,40
TBPZ4825	4,8x25	PH2	4,40 Max.	15,80	500	6.000	4,01
TBPZ4832	4,8x32	PH2	4,40 Max.	22,80	500	6.000	5,14
TBPZ4838	4,8x38	PH2	4,40 Max.	28,80	500	3.000	5,81
TBPZ4845	4,8x45	PH2	4,40 Max.	35,80	500	3.000	7,98
TBPZ4850	4,8x50	PH2	4,40 Max.	40,80	500	3.000	7,56
TBPZ4860	4,8x60	PH2	4,40 Max.	50,80	250	1.500	10,60
TBPZ4870	4,8x70	PH2	4,40 Max.	60,80	250	1.500	11,30
TBPZ4880	4,8x80	PH2	4,40 Max.	70,80	250	1.500	14,20
TBPZ5519	5,5x19	PH3	5,25 Max.	8,35	500	6.000	4,83
TBPZ5525	5,5x25	PH3	5,25 Max.	14,35	500	6.000	5,58
TBPZ5532	5,5x32	PH3	5,25 Max.	21,35	500	6.000	6,77
TBPZ5538	5,5x38	PH3	5,25 Max.	27,35	500	3.000	7,86
TBPZ5550	5,5x50	PH3	5,25 Max.	39,35	500	3.000	9,92
TBPZ5560	5,5x60	PH3	5,25 Max.	49,35	250	1.500	14,20
TBPZ5570	5,5x70	PH3	5,25 Max.	59,35	250	1.500	15,10
TBPZ5580	5,5x80	PH3	5,25 Max.	69,35	250	1.500	19,15

DIN-7504-P / TBPN

Zincado negro



ZINCADO NEGRO

CÓDIGO CODE	MEDIDA SIZE		CAP.	MAX.			€/ 100
TBPN3513	3,5x13	PH2	2,25 Max.	6,85	1.000	24.000	2,48
TBPN3516	3,5x16	PH2	2,25 Max.	9,85	1.000	24.000	2,73
TBPN3519	3,5x19	PH2	2,25 Max.	12,85	1.000	12.000	3,12
TBPN3525	3,5x25	PH2	2,25 Max.	18,85	500	12.000	3,87
TBPN4216	4,2x16	PH2	3,00 Max.	8,80	1.000	12.000	3,50
TBPN4219	4,2x19	PH2	3,00 Max.	11,80	1.000	12.000	3,98
TBPN4225	4,2x25	PH2	3,00 Max.	17,80	500	6.000	4,85
TBPN4232	4,2x32	PH2	3,00 Max.	24,80	500	6.000	5,88
TBPN4238	4,2x38	PH2	3,00 Max.	30,80	500	6.000	7,44
TBPN4825	4,8x25	PH2	4,40 Max.	15,80	500	6.000	6,39
TBPN4832	4,8x32	PH2	4,40 Max.	22,80	500	6.000	7,87
TBPN4838	4,8x38	PH2	4,40 Max.	28,80	500	3.000	9,16
TBPN4850	4,8x50	PH2	4,40 Max.	40,80	500	3.000	11,33

TPVC-10

Tornillo cabeza avellanada para PVC, ROSCA HI-LO, cabeza Ø 7,5 mm.



PVC
PVC windows



SOLICITAR
FICHA TÉCNICA



ZINCADO

CÓDIGO CODE	MEDIDA SIZE				€ / 100
TPV10Z3925	3,9x25	PH2	1.000	12.000	3,11
TPV10Z3930	3,9x30	PH2	1.000	12.000	3,50
TPV10Z3938	3,9x38	PH2	500	6.000	4,68
TPV10Z3945	3,9x45	PH2	500	3.000	5,17

TPVC-20

Tornillo cabeza avellanada, FILETE 40°, para PVC, cabeza reducida Ø 7 mm.



PVC
PVC windows



ZINCADO

CÓDIGO CODE	MEDIDA SIZE				€ / 100
TPV20Z4316	4,3x16	PH2	1.000	24.000	2,58
TPV20Z4319	4,3x19	PH2	1.000	12.000	2,73
TPV20Z4322	4,3x22	PH2	1.000	12.000	2,98
TPV20Z4325	4,3x25	PH2	1.000	12.000	3,10
TPV20Z4330	4,3x30	PH2	1.000	6.000	3,60
TPV20Z4338	4,3x38	PH2	500	6.000	4,40
TPV20Z4345	4,3x45	PH2	500	3.000	5,43
TPV20Z4355	4,3x55	PH2	500	3.000	6,85

BICROMATADO

CÓDIGO CODE	MEDIDA SIZE				€ / 100
* TPV20B4316	4,3x16	PH2	1.000	24.000	2,58
* TPV20B4319	4,3x19	PH2	1.000	12.000	2,73
* TPV20B4322	4,3x22	PH2	1.000	12.000	2,98
* TPV20B4325	4,3x25	PH2	1.000	12.000	3,10
* TPV20B4330	4,3x30	PH2	1.000	6.000	3,60
* TPV20B4338	4,3x38	PH2	500	6.000	4,40
* TPV20B4345	4,3x45	PH2	500	3.000	5,43
* TPV20B4355	4,3x55	PH2	500	3.000	6,85

(*) HASTA FINAL DE EXISTENCIAS

TPVC-40

Tornillo autotaladrante, cabeza avellanada, para PVC, PUNTA PILOTO, cabeza Ø 7,5 mm.



PVC
PVC windows



ZINCADO

CÓDIGO CODE	MEDIDA SIZE				€ / 100
TPV40Z3913	3,9x13	PH2	1.000	24.000	2,19
TPV40Z3916	3,9x16	PH2	1.000	16.000	2,66
TPV40Z3919	3,9x19	PH2	1.000	12.000	2,92
TPV40Z3922	3,9x22	PH2	1.000	12.000	3,20
TPV40Z3925	3,9x25	PH2	1.000	12.000	3,51
TPV40Z3932	3,9x32	PH2	1.000	6.000	4,43
TPV40Z3938	3,9x38	PH2	500	6.000	5,15

TPVC-50

Tornillo autotaladrante, cabeza avellanada, para PVC, ROSCA MÉTRICA, cabeza Ø 7,5 mm.



PVC
PVC windows

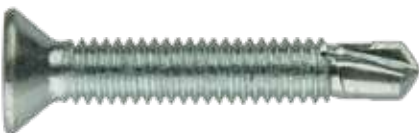

ZINCADO

CÓDIGO CODE	MEDIDA SIZE				€ / 100
TPV50ZM413	M-4x13	PH2	1.000	24.000	2,77
TPV50ZM416	M-4x16	PH2	1.000	24.000	2,94
TPV50ZM419	M-4x19	PH2	1.000	12.000	3,44
TPV50ZM425	M-4x25	PH2	1.000	12.000	4,30
TPV50ZM432	M-4x32	PH2	1.000	6.000	4,92
TPV50ZM438	M-4 x38	PH2	500	6.000	6,58

DIN-7981 / TR81

Tornillos rosca chapa, DIN-7981,
CABEZA ALOMADA, Phillips



ensamblaje de chapas
metal panels

perfiles de chapa
metal elements

carpintería aluminio
aluminium windows



SOLICITAR
FICHA TÉCNICA



P.198



PUNTAS

DISPONIBLE, VER PÁGINA:

P. 132



DISPONIBLE EN
COLORES RAL



ZINCADO

CÓDIGO CODE	MEDIDA SIZE				€/ 100
TR81Z29006	2,9x6,5	PH1	1.000	45.000	1,42
TR81Z29009	2,9x9,5	PH1	1.000	30.000	1,47
TR81Z29013	2,9x13	PH1	1.000	24.000	1,48
TR81Z29016	2,9x16	PH1	1.000	24.000	1,82
TR81Z29019	2,9x19	PH1	1.000	24.000	1,87
TR81Z29022	2,9x22	PH1	1.000	12.000	2,15
TR81Z29025	2,9x25	PH1	500	12.000	2,32
TR81Z35006	3,5x6,5	PH2	1.000	24.000	1,48
TR81Z35009	3,5x9,5	PH2	1.000	24.000	1,52
TR81Z35013	3,5x13	PH2	500	22.500	1,81
TR81Z35016	3,5x16	PH2	500	12.000	2,16
TR81Z35019	3,5x19	PH2	500	12.000	2,29
TR81Z35025	3,5x25	PH2	250	11.250	3,06
TR81Z35032	3,5x32	PH2	250	6.000	3,60
TR81Z39009	3,9x9,5	PH2	500	15.000	1,97
TR81Z39013	3,9x13	PH2	500	12.000	2,21
TR81Z39016	3,9x16	PH2	500	12.000	2,75
TR81Z39019	3,9x19	PH2	500	12.000	2,88
TR81Z39022	3,9x22	PH2	250	7.500	3,47
TR81Z39025	3,9x25	PH2	250	6.000	3,52
TR81Z39032	3,9x32	PH2	250	6.000	3,84
TR81Z39038	3,9x38	PH2	250	6.000	4,49
TR81Z39045	3,9x45	PH2	250	3.000	5,31
TR81Z39050	3,9x50	PH2	250	3.000	5,90
TR81Z42009	4,2x9,5	PH2	500	12.000	2,25
TR81Z42013	4,2x13	PH2	500	12.000	2,43
TR81Z42016	4,2x16	PH2	500	12.000	2,86
TR81Z42019	4,2x19	PH2	500	12.000	3,01
TR81Z42022	4,2x22	PH2	250	6.000	3,64
TR81Z42025	4,2x25	PH2	250	6.000	3,75
TR81Z42032	4,2x32	PH2	250	6.000	4,39
TR81Z42038	4,2x38	PH2	250	3.000	5,13
TR81Z42045	4,2x45	PH2	250	3.000	5,53
TR81Z42050	4,2x50	PH2	250	3.000	6,65
TR81Z42060	4,2x60	PH2	250	3.000	8,22
TR81Z42070	4,2x70	PH2	250	1.500	9,24
TR81Z42080	4,2x80	PH2	250	1.500	11,00
TR81Z42090	4,2x90	PH2	250	1.500	14,95
TR81Z48009	4,8x9,5	PH2	500	12.000	3,41
TR81Z48013	4,8x13	PH2	500	8.000	3,33
TR81Z48016	4,8x16	PH2	250	6.000	3,73
TR81Z48019	4,8x19	PH2	250	6.000	4,29
TR81Z48022	4,8x22	PH2	250	6.000	5,11

ZINCADO

CÓDIGO CODE	MEDIDA SIZE				€/ 100
TR81Z48025	4,8x25	PH2	250	6.000	4,99
TR81Z48032	4,8x32	PH2	250	4.000	5,52
TR81Z48038	4,8x38	PH2	250	3.000	6,45
TR81Z48045	4,8x45	PH2	250	3.000	7,85
TR81Z48050	4,8x50	PH2	250	3.000	8,15
TR81Z48060	4,8x60	PH2	250	1.500	10,27
TR81Z48070	4,8x70	PH2	100	1.200	12,20
TR81Z48080	4,8x80	PH2	100	1.200	14,98
TR81Z48090	4,8x90	PH2	100	1.200	17,88
TR81Z48100	4,8x100	PH2	100	1.200	19,88
TR81Z48110	4,8x110	PH2	100	1.200	24,95
TR81Z48120	4,8x120	PH2	100	1.200	29,46
TR81Z55013	5,5x13	PH3	250	6.000	5,16
TR81Z55016	5,5x16	PH3	250	6.000	5,32
TR81Z55019	5,5x19	PH3	250	6.000	5,62
TR81Z55022	5,5x22	PH3	250	4.000	6,62
TR81Z55025	5,5x25	PH3	250	4.000	6,72
TR81Z55032	5,5x32	PH3	250	3.000	8,25
TR81Z55038	5,5x38	PH3	250	3.000	8,59
TR81Z55045	5,5x45	PH3	250	3.000	10,12
TR81Z55050	5,5x50	PH3	250	1.500	10,74
TR81Z55060	5,5x60	PH3	100	1.200	13,35
TR81Z55070	5,5x70	PH3	100	1.200	14,82
TR81Z55080	5,5x80	PH3	100	1.200	19,03
TR81Z55090	5,5x90	PH3	100	1.200	22,36
TR81Z55100	5,5x100	PH3	100	1.200	26,13
TR81Z55110	5,5x110	PH3	100	1.200	30,11
TR81Z55120	5,5x120	PH3	100	1.200	36,71
TR81Z63016	6,3x16	PH3	250	4.000	6,97
TR81Z63019	6,3x19	PH3	250	3.000	7,63
TR81Z63022	6,3x22	PH3	250	3.000	8,00
TR81Z63025	6,3x25	PH3	250	3.000	8,49
TR81Z63032	6,3x32	PH3	250	3.000	10,95
TR81Z63038	6,3x38	PH3	250	1.500	12,73
TR81Z63045	6,3x45	PH3	250	1.500	14,49
TR81Z63050	6,3x50	PH3	250	1.500	15,43
TR81Z63060	6,3x60	PH3	100	1.200	18,77
TR81Z63070	6,3x70	PH3	100	1.200	20,28
TR81Z63080	6,3x80	PH3	100	1.200	25,83
TR81Z63090	6,3x90	PH3	50	600	32,13
TR81Z63100	6,3 x100	PH3	50	600	34,05
TR81Z63110	6,3 x110	PH3	50	600	37,73
TR81Z63120	6,3 x120	PH3	50	600	40,48

DIN-7981 / TR81N

Zincado negro



ZINCADO NEGRO

CÓDIGO CODE	MEDIDA SIZE				€/ 100
TR81N29009	2,9x9,5	PH1	1.000	30.000	2,06
TR81N35009	3,5x9,5	PH2	1.000	24.000	2,67
TR81N35013	3,5x13	PH2	500	22.500	2,72
TR81N35016	3,5x16	PH2	500	12.000	3,33
TR81N35019	3,5x19	PH2	500	12.000	3,77
TR81N35025	3,5x25	PH2	250	11.250	4,90
TR81N42016	4,2x16	PH2	500	12.000	4,34
TR81N42019	4,2x19	PH2	500	12.000	4,70
TR81N42025	4,2x25	PH2	250	6.000	5,81
TR81N42032	4,2x32	PH2	250	6.000	7,41
TR81N42038	4,2x38	PH2	250	3.000	8,39
TR81N48016	4,8x16	PH2	250	6.000	6,05
TR81N48019	4,8x19	PH2	250	6.000	6,68

ZINCADO NEGRO

CÓDIGO CODE	MEDIDA SIZE				€/ 100
TR81N48022	4,8x22	PH2	250	6.000	7,51
TR81N48025	4,8x25	PH2	250	6.000	7,40
TR81N48032	4,8x32	PH2	250	4.000	9,28
TR81N48038	4,8x38	PH2	250	3.000	10,36
TR81N48045	4,8x45	PH2	250	3.000	13,70
TR81N48050	4,8x50	PH2	250	3.000	14,08
TR81N48060	4,8x60	PH2	250	1.500	20,81
TR81N48070	4,8x70	PH2	100	1.200	23,61
TR81N48080	4,8x80	PH2	100	1.200	26,36
TR81N48090	4,8x90	PH2	100	1.200	31,75
TR81N48100	4,8x100	PH2	100	1.200	34,99
TR81N48110	4,8x110	PH2	100	1.200	38,22
TR81N48120	4,8x120	PH2	100	1.200	41,56

DIN-7981 / TR81P

Tornillos rosca chapa, DIN-7981, CABEZA ALOMADA, Phillips, PINTADO BLANCO



ensamblaje de chapas metal panels perfiles de chapa metal elements carpintería aluminio aluminium windows



ZINCADO + PINTADO

PINTADO BLANCO

CÓDIGO CODE	MEDIDA SIZE				€/ 100
TR81P35009	3,5x9,5	PH2	1.000	24.000	3,28
TR81P35013	3,5x13	PH2	500	22.500	4,82
TR81P35016	3,5x16	PH2	500	12.000	5,00
TR81P35025	3,5x25	PH2	250	11.250	7,25
TR81P42013	4,2x13	PH2	500	12.000	5,21
NEW TR81P42016	4,2x16	PH2	500	12.000	5,50
TR81P42025	4,2x25	PH2	250	6.000	8,17
TR81P42032	4,2x32	PH2	250	6.000	11,76
TR81P48025	4,8x25	PH2	250	6.000	13,56

DIN-7982 / TR82

Tornillos rosca chapa, CABEZA AVELLANADA 80°, Phillips



ensamblaje de chapas metal panels perfiles de chapa metal elements carpintería aluminio aluminium windows



PUNTAS

DISPONIBLE, VER PÁGINA:

P. 132



DISPONIBLE EN COLORES RAL



SOLICITAR FICHA TÉCNICA

ZINCADO

CÓDIGO CODE	MEDIDA SIZE				€/ 100
TR82Z29006	2,9x6,5	PH1	1.000	45.000	1,70
TR82Z29009	2,9x9,5	PH1	1.000	45.000	1,51
TR82Z29013	2,9x13	PH1	1.000	45.000	1,43
TR82Z29016	2,9x16	PH1	1.000	24.000	1,50
TR82Z29019	2,9x19	PH1	1.000	24.000	1,70
TR82Z29022	2,9x22	PH1	1.000	24.000	1,69
TR82Z29025	2,9x25	PH1	500	12.000	2,15
TR82Z35009	3,5x9,5	PH2	1.000	24.000	1,51
TR82Z35013	3,5x13	PH2	500	22.500	1,69
TR82Z35016	3,5x16	PH2	500	22.500	1,90
TR82Z35019	3,5x19	PH2	500	12.000	2,10
TR82Z35022	3,5x22	PH2	500	12.000	2,29
TR82Z35025	3,5x25	PH2	250	11.250	2,74
TR82Z35032	3,5x32	PH2	250	6.000	3,33
TR82Z35038	3,5x38	PH2	250	6.000	3,79
TR82Z39009	3,9x9,5	PH2	500	22.500	1,81
TR82Z39013	3,9x13	PH2	500	22.500	1,94
TR82Z39016	3,9x16	PH2	500	12.000	2,24
TR82Z39019	3,9x19	PH2	500	12.000	2,47
TR82Z39022	3,9x22	PH2	250	11.250	3,14
TR82Z39025	3,9x25	PH2	250	6.000	3,35
TR82Z39032	3,9x32	PH2	250	6.000	4,06
TR82Z39038	3,9x38	PH2	250	6.000	4,43
TR82Z39045	3,9x45	PH2	250	3.000	5,04
TR82Z39050	3,9x50	PH2	250	3.000	5,80
TR82Z42013	4,2x13	PH2	500	15.000	2,17
TR82Z42016	4,2x16	PH2	500	12.000	2,41
TR82Z42019	4,2x19	PH2	500	12.000	2,81
TR82Z42022	4,2x22	PH2	250	11.250	3,39
TR82Z42025	4,2x25	PH2	250	6.000	3,75
TR82Z42032	4,2x32	PH2	250	6.000	4,19
TR82Z42038	4,2x38	PH2	250	6.000	4,94
TR82Z42045	4,2x45	PH2	250	3.000	5,71

ZINCADO

CÓDIGO CODE	MEDIDA SIZE				€/ 100
TR82Z42050	4,2x50	PH2	250	3.000	6,26
TR82Z42060	4,2x60	PH2	250	3.000	8,10
TR82Z42070	4,2x70	PH2	250	3.000	9,60
TR82Z48013	4,8x13	PH2	500	12.000	2,91
TR82Z48016	4,8x16	PH2	250	11.250	3,40
TR82Z48019	4,8x19	PH2	250	6.000	3,98
TR82Z48022	4,8x22	PH2	250	6.000	4,38
TR82Z48025	4,8x25	PH2	250	6.000	4,97
TR82Z48032	4,8x32	PH2	250	6.000	5,43
TR82Z48038	4,8x38	PH2	250	3.000	6,68
TR82Z48045	4,8x45	PH2	250	3.000	7,53
TR82Z48050	4,8x50	PH2	250	3.000	9,00
TR82Z48060	4,8x60	PH2	250	1.500	10,04
TR82Z48070	4,8x70	PH2	100	2.400	12,51
TR82Z55013	5,5x13	PH3	250	7.500	4,01
TR82Z55016	5,5x16	PH3	250	6.000	4,49
TR82Z55019	5,5x19	PH3	250	6.000	5,16
TR82Z55022	5,5x22	PH3	250	6.000	6,01
TR82Z55025	5,5x25	PH3	250	6.000	6,48
TR82Z55032	5,5x32	PH3	250	3.000	7,63
TR82Z55038	5,5x38	PH3	250	3.000	8,31
TR82Z55045	5,5x45	PH3	250	3.000	9,92
TR82Z55050	5,5x50	PH3	250	1.500	12,39
TR82Z55060	5,5x60	PH3	100	1.200	14,10
TR82Z55070	5,5x70	PH3	100	1.200	15,86
TR82Z63025	6,3x25	PH3	250	3.000	9,22
TR82Z63032	6,3x32	PH3	250	3.000	10,93
TR82Z63038	6,3x38	PH3	250	3.000	11,78
TR82Z63045	6,3x45	PH3	250	1.500	11,75
TR82Z63050	6,3x50	PH3	250	1.500	13,94
TR82Z63060	6,3x60	PH3	100	1.200	19,47
TR82Z63070	6,3x70	PH3	100	1.200	20,36

TAU

Tornillo autorroscante DIN-6928, CABEZA HEXAGONAL, con arandela estampada



ensamblaje de chapas
metal panels

perfiles de chapa
metal elements



BOCAS / VASOS
DISPONIBLE, VER PÁGINA:

P. 131



DISPONIBLE EN
COLORES RAL



ZINCADO

CÓDIGO CODE	MEDIDA SIZE	Ø	Ø	MAX.	500	3.000	€/ 100
TAU63016	6,3x 16	10	5,00 - 5,10	3	500	3.000	8,54
TAU63019	6,3x 19	10	5,00 - 5,10	4	500	3.000	8,66
TAU63025	6,3x 25	10	5,00 - 5,10	10	500	3.000	10,03
TAU63032	6,3x 32	10	5,00 - 5,10	17	500	3.000	13,80
TAU63040	6,3x 40	10	5,00 - 5,10	25	500	2.000	13,96
TAU63050	6,3x 50	10	5,00 - 5,10	35	500	1.500	15,27
TAU63060	6,3x 60	10	5,00 - 5,10	45	250	1.000	17,62
TAU63070	6,3x70	10	5,00 - 5,10	55	250	1.000	22,80
TAU63080	6,3x 80	10	5,00 - 5,10	65	250	1.000	23,57
TAU63090	6,3x90	10	5,00 - 5,10	75	250	750	30,32
TAU63100	6,3x100	10	5,00 - 5,10	85	250	750	30,65
TAU63110	6,3x110	10	5,00 - 5,10	95	250	750	36,38
TAU63120	6,3x120	10	5,00 - 5,10	105	250	750	40,43
TAU63130	6,3x130	10	5,00 - 5,10	115	250	750	52,24
TAU63140	6,3x140	10	5,00 - 5,10	125	100	400	61,34
TAU63150	6,3x150	10	5,00 - 5,10	135	100	400	67,27
TAU63160	6,3x160	10	5,00 - 5,10	145	50	400	79,33
TAU63180	6,3 x 180	10	5,00 - 5,10	165	50	400	110,44
TAU63200	6,3 x 200	10	5,00 - 5,10	185	50	400	124,83
TAU63220	6,3x220	10	5,00 - 5,10	205	50	400	132,14
TAU63240	6,3x240	10	5,00 - 5,10	225	50	400	138,20

TAU + ARNE

Con arandela EPDM, montada



ensamblaje de chapas
metal panels

perfiles de chapa
metal elements



MEDIDAS EN COLOR ROJO, CONSULTAR PLAZO

MEDIDA SIZE	ARANDELA MONTADA P-14		ARANDELA MONTADA P-16	
	CÓDIGO CODE	€/ 100	CÓDIGO CODE	€/ 100
6,3x 16	TAU1463016	500 15,37	TAU1663016	500 17,08
6,3x 19	TAU1463019	500 15,58	TAU1663019	500 15,46
6,3x 25	TAU1463025	500 18,06	TAU1663025	500 16,37
6,3x 32	TAU1463032	500 20,01	TAU1663032	500 18,72
6,3x 40	TAU1463040	500 23,43	TAU1663040	500 20,69
6,3x 50	TAU1463050	250 27,49	TAU1663050	250 24,30
6,3x 60	TAU1463060	250 31,71	TAU1663060	250 28,00
6,3x 80	TAU1463080	250 41,04	TAU1663080	250 35,72
6,3x100	TAU1463100	250 42,43	TAU1663100	250 47,15
6,3x110	TAU1463110	250 53,46	TAU1663110	250 59,40
6,3x120	TAU1463120	125 54,15	TAU1663120	125 60,17
6,3x130	TAU1463130	125 65,48	TAU1663130	125 72,76
6,3x140	TAU1463140	125 72,78	TAU1663140	125 80,86
6,3x150	TAU1463150	125 87,76	TAU1663150	125 97,51

MEDIDA SIZE	ARANDELA MONTADA P-18		ARANDELA MONTADA P-25	
	CÓDIGO CODE	€/ 100	CÓDIGO CODE	€/ 100
6,3x 16	TAU1863016	500 18,36	TAU2563016	500 20,50
6,3x 19	TAU1863019	500 18,61	TAU2563019	500 20,78
6,3x 25	TAU1863025	500 18,97	TAU2563025	500 25,05
6,3x 32	TAU1863032	500 21,02	TAU2563032	250 28,69
6,3x 40	TAU1863040	500 24,81	TAU2563040	250 31,23
6,3x 50	TAU1863050	250 25,81	TAU2563050	250 36,66
6,3x 60	TAU1863060	250 30,27	TAU2563060	250 42,28
6,3x 80	TAU1863080	250 39,23	TAU2563080	125 54,72
6,3x100	TAU1863100	250 45,81	TAU2563100	100 56,58
6,3x110	TAU1863110	250 51,92	TAU2563110	100 71,28
6,3x120	TAU1863120	125 59,71	TAU2563120	100 72,20
6,3x130	TAU1863130	125 69,80	TAU2563130	100 87,31
6,3x140	TAU1863140	125 75,76	TAU2563140	100 97,04
6,3x150	TAU1863150	125 77,60	TAU2563150	100 117,01

TINV

Tornillo INVOLABLE, huella TX-40



madera
wood

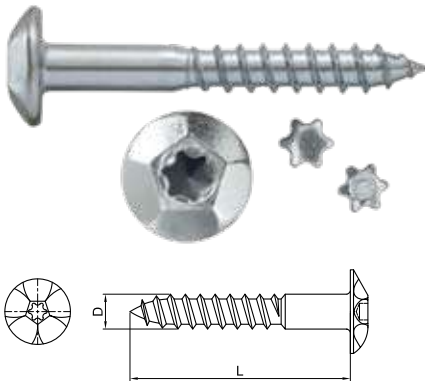

ZINCADO

CÓDIGO CODE	MEDIDA SIZE		Ø			€/ 100
TINVZ6040	6x40	TX40	16,30 - 17,00	100	1.200	23,86
TINVZ6050	6x50	TX40	16,30 - 17,00	100	1.200	25,77
TINVZ6060	6x60	TX40	16,30 - 17,00	100	600	27,14
TINVZ6070	6x70	TX40	16,30 - 17,00	100	600	31,35
TINVZ7030	7x30	TX40	16,30 - 17,00	100	1.200	21,71
TINVZ7040	7x40	TX40	16,30 - 17,00	100	1.200	22,59
TINVZ7050	7x50	TX40	16,30 - 17,00	100	1.200	25,93
TINVZ7060	7x60	TX40	16,30 - 17,00	100	600	26,74
TINVZ7070	7x70	TX40	16,30 - 17,00	100	600	27,50
TINVZ7080	7x80	TX40	16,30 - 17,00	100	600	33,28
TINVZ7090	7x90	TX40	16,30 - 17,00	100	600	38,32
TINVZ7105	7x105	TX40	16,30 - 17,00	100	600	51,06
TINVZ7125	7x125	TX40	16,30 - 17,00	100	600	101,34
TINVZ7145	7x145	TX40	16,30 - 17,00	100	400	134,19
TINVZ7165	7x165	TX40	16,30 - 17,00	100	300	154,64
* TINVZ7205	7x205	TX40	16,30 - 17,00	100	300	251,77

(*) HASTA FINAL DE EXISTENCIAS



ZINCADO NEGRO

CÓDIGO CODE	MEDIDA SIZE		Ø			€/ 100
TINVN6040	6x40	TX40	16,30 - 17,00	100	1.200	27,47
TINVN6050	6x50	TX40	16,30 - 17,00	100	1.200	28,94
TINVN6060	6x60	TX40	16,30 - 17,00	100	600	31,40
TINVN6070	6x70	TX40	16,30 - 17,00	100	600	34,45
TINVN7030	7x30	TX40	16,30 - 17,00	100	1.200	24,67
TINVN7040	7x40	TX40	16,30 - 17,00	100	1.200	27,10
TINVN7050	7x50	TX40	16,30 - 17,00	100	1.200	30,01
TINVN7060	7x60	TX40	16,30 - 17,00	100	600	35,44
TINVN7070	7x70	TX40	16,30 - 17,00	100	600	35,90
TINVN7080	7x80	TX40	16,30 - 17,00	100	600	41,88
TINVN7090	7x90	TX40	16,30 - 17,00	100	600	45,86

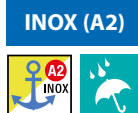

INOXIDABLE A2

CÓDIGO CODE	MEDIDA SIZE		Ø			€/ 100
TINVI7050	7x50	TX40	16,30 - 17,00	100	1.200	125,85
TINVI7060	7x60	TX40	16,30 - 17,00	100	600	166,68
TINVI7070	7x70	TX40	16,30 - 17,00	100	600	145,54
TINVI7080	7x80	TX40	16,30 - 17,00	100	600	189,47

ESTINV

ESTRELLA ZAMAK, para tornillo involable, huella TX-40



ZINCADO

CÓDIGO CODE	MEDIDA SIZE			€/ 100
ESTINVZ	ESTRELLA / STAR TX40	100	1.200	4,15

ZINCADO NEGRO

CÓDIGO CODE	MEDIDA SIZE			€/ 100
ESTINVN	ESTRELLA / STAR TX40	100	1.200	4,87

DIN-571 / TBA

Tornillo barraquero, CABEZA HEXAGONAL



madera
wood



ZINCADO

CÓDIGO CODE	MEDIDA SIZE				€/ 100
TBAZ05030	5x 30	8	200	4.800	4,86
TBAZ05040	5x 40	8	200	2.400	7,69
TBAZ05050	5x 50	8	200	2.400	7,48
TBAZ05060	5x 60	8	200	2.400	9,51
TBAZ06025	6x 25	10	200	2.400	5,73
TBAZ06030	6x 30	10	200	2.400	7,38
TBAZ06035	6x 35	10	200	2.400	7,30
TBAZ06040	6x 40	10	200	2.400	7,43
TBAZ06045	6x 45	10	200	2.400	8,33
TBAZ06050	6x 50	10	200	2.400	8,80
TBAZ06060	6x 60	10	200	1.200	10,49
TBAZ06070	6x 70	10	200	1.200	12,07
TBAZ06080	6x 80	10	200	1.200	13,94
TBAZ06090	6x 90	10	100	1.200	16,24
TBAZ06100	6x100	10	100	1.200	18,17
TBAZ06110	6x110	10	100	1.200	21,28
TBAZ06120	6x120	10	100	800	21,57
TBAZ07030	7x 30	12	200	2.400	11,11
TBAZ07040	7x 40	12	200	1.600	13,15
TBAZ07050	7x 50	12	200	1.200	14,58
TBAZ07060	7x 60	12	100	1.200	16,67
TBAZ07070	7x 70	12	100	1.200	19,55
TBAZ07080	7x 80	12	100	800	21,78
TBAZ07090	7x 90	12	100	400	22,59
TBAZ07100	7x100	12	100	600	25,04
TBAZ07110	7x110	12	100	600	28,70
TBAZ07120	7x120	12	100	600	30,30
TBAZ07150	7x150	12	100	400	33,60
TBAZ08030	8x 30	13	200	1.200	12,62
TBAZ08040	8x 40	13	200	1.200	14,63
TBAZ08045	8x 45	13	200	1.200	16,03
TBAZ08050	8x 50	13	200	1.200	16,29
TBAZ08060	8x 60	13	200	1.200	18,04
TBAZ08070	8x 70	13	200	800	20,51
TBAZ08080	8x 80	13	200	800	23,12
TBAZ08090	8x 90	13	100	600	28,31
TBAZ08100	8x100	13	100	600	30,62
TBAZ08110	8x110	13	100	600	32,90

ZINCADO

CÓDIGO CODE	MEDIDA SIZE				€/ 100
TBAZ08120	8x120	13	100	600	34,50
TBAZ08130	8x130	13	100	400	40,54
TBAZ08140	8x140	13	100	400	42,16
TBAZ08150	8x150	13	100	400	45,30
TBAZ08160	8x160	13	100	400	48,00
TBAZ08180	8x180	13	100	300	59,68
TBAZ08200	8x200	13	100	300	65,32
TBAZ10040	10x 40	17	100	600	27,12
TBAZ10050	10x 50	17	100	600	29,49
TBAZ10060	10x 60	17	100	600	32,82
TBAZ10070	10x 70	17	100	600	36,27
TBAZ10080	10x 80	17	100	400	40,01
TBAZ10090	10x 90	17	100	400	47,32
TBAZ10100	10x100	17	100	400	47,93
TBAZ10110	10x110	17	50	300	53,73
TBAZ10120	10x120	17	50	300	57,81
TBAZ10130	10x130	17	50	300	63,04
TBAZ10140	10x140	17	50	300	70,50
TBAZ10150	10x150	17	50	300	79,69
TBAZ10160	10x160	17	50	200	85,07
TBAZ10180	10x180	17	50	150	95,26
TBAZ10200	10x200	17	50	150	102,56
TBAZ12060	12x 60	19	50	300	50,34
TBAZ12070	12x 70	19	50	300	55,39
TBAZ12080	12x 80	19	50	300	59,15
TBAZ12090	12x 90	19	50	300	65,66
TBAZ12100	12x100	19	50	300	71,54
TBAZ12120	12x120	19	50	300	85,19
TBAZ12130	12x130	19	50	200	93,42
TBAZ12140	12x140	19	50	200	99,49
TBAZ12150	12x150	19	50	200	106,21
TBAZ12160	12x160	19	50	200	116,28
TBAZ12180	12x180	19	50	150	133,30
TBAZ12200	12x200	19	50	150	150,27
TBAZ12220	12x220	19	25	75	171,38
TBAZ12240	12x240	19	25	75	183,81
TBAZ12260	12x260	19	25	50	201,51
TBAZ14100	14x100	22	50	200	132,34



DIN-571 / TBA-RT

Tornillo barraquero, CABEZA HEXAGONAL,
ROSCA TOTAL



ZINCADO

CÓDIGO CODE	MEDIDA SIZE				€/ 100
TBART06050	6x50	10	200	2.400	9,24
TBART06060	6x60	10	200	1.200	10,70
TBART06070	6x70	10	200	1.200	12,31
TBART08050	8x50	13	200	1.200	16,61
TBART08060	8x60	13	200	1.200	18,40

ZINCADO

CÓDIGO CODE	MEDIDA SIZE				€/ 100
TBART08070	8x70	13	200	800	20,92
TBART08080	8x80	13	200	800	23,59
TBART10060	10x60	17	100	600	33,47
TBART10080	10x80	17	100	400	40,81

DIN-571 / TBA-INOX A2

Tornillo barraquero, CABEZA HEXAGONAL,
INOX A2 (AISI 304)

INOX (A2)



INOXIDABLE A2

CÓDIGO CODE	MEDIDA SIZE				€/ 100
TBAI06040	6x40	10	100	2.400	28,83
TBAI06050	6x50	10	100	1.200	35,03
TBAI06060	6x60	10	100	1.200	41,93
TBAI06070	6x70	10	100	1.200	45,04
TBAI08050	8x50	13	100	1.200	65,34
TBAI08060	8x60	13	100	600	74,95
TBAI08070	8x70	13	100	600	86,50

INOXIDABLE A2

CÓDIGO CODE	MEDIDA SIZE				€/ 100
TBAI08080	8x80	13	100	600	92,65
TBAI08100	8x100	13	100	600	98,00
TBAI08120	8x120	13	100	600	130,00
TBAI10060	10x60	17	100	600	110,00
TBAI10080	10x80	17	100	400	162,03
TBAI10100	10x100	17	100	400	178,00
TBAI10120	10x120	17	50	300	215,00

TTXEB

Tornillo autotaladrante, CABEZA AVELLANADA, huella TX, punta fresada "type 17"



madera
wood



BICROMATADO

CÓDIGO CODE	MEDIDA SIZE				€ / 100
TTXEB30016	3,0x16	TX10	1.000	24.000	2,22
TTXEB30020	3,0x20	TX10	1.000	24.000	2,29
TTXEB30025	3,0x25	TX10	500	12.000	2,94
TTXEB30030	3,0x30	TX10	500	12.000	3,40
TTXEB30035	3,0x35	TX10	500	12.000	3,45
TTXEB30040	3,0x40	TX10	500	6.000	3,76
TTXEB35016	3,5x16	TX15	1.000	24.000	2,56
TTXEB35020	3,5x20	TX15	1.000	12.000	2,67
TTXEB35025	3,5x25	TX15	500	12.000	3,33
TTXEB35030	3,5x30	TX15	500	12.000	3,90
TTXEB35035	3,5x35	TX15	500	6.000	4,13
TTXEB35040	3,5x40	TX15	500	6.000	5,00
TTXEB35045	3,5x45	TX15	200	4.800	5,59
TTXEB35050	3,5x50	TX15	200	4.800	6,31
TTXEB35060	3,5x60	TX15	200	2.400	8,90
TTXEB40016	4,0x16	TX20	500	12.000	2,90
TTXEB40020	4,0x20	TX20	500	12.000	3,30
TTXEB40025	4,0x25	TX20	500	12.000	3,73
TTXEB40030	4,0x30	TX20	500	6.000	4,13
TTXEB40035	4,0x35	TX20	500	6.000	4,99
TTXEB40040	4,0x40	TX20	500	6.000	5,47
TTXEB40045	4,0x45	TX20	500	6.000	6,70
TTXEB40050	4,0x50	TX20	200	4.800	6,86
TTXEB40060	4,0x60	TX20	200	2.400	8,83
TTXEB40070	4,0x70	TX20	200	2.400	10,38
TTXEB45030	4,5x30	TX25	500	6.000	5,19
TTXEB45035	4,5x35	TX25	200	4.800	6,31
TTXEB45040	4,5x40	TX25	200	4.800	6,53
TTXEB45045	4,5x45	TX25	200	2.400	7,68
TTXEB45050	4,5x50	TX25	200	2.400	7,83
TTXEB45060	4,5x60	TX25	200	2.400	10,26
TTXEB45070	4,5x70	TX25	200	2.400	12,59
TTXEB45080	4,5x80	TX25	200	2.400	16,60
TTXEB50030	5,0x30	TX25	200	4.800	7,22
TTXEB50035	5,0x35	TX25	200	4.800	7,75
TTXEB50040	5,0x40	TX25	200	2.400	8,42
TTXEB50045	5,0x45	TX25	200	2.400	9,79
TTXEB50050	5,0x50	TX25	200	2.400	10,57
TTXEB50060	5,0x60	TX25	200	2.400	13,15
TTXEB50070	5,0x70	TX25	200	2.400	15,47
TTXEB50080	5,0x80	TX25	200	1.200	19,73
TTXEB50090	5,0x90	TX25	100	1.200	19,87
TTXEB50100	5,0 x100	TX25	100	1.200	22,36
TTXEB50110	5,0 x110	TX25	100	1.200	26,58
TTXEB50120	5,0 x120	TX25	100	1.200	29,33
TTXEB60040	6,0x40	TX30	200	2.400	13,50
TTXEB60045	6,0x45	TX30	200	2.400	19,94
TTXEB60050	6,0x50	TX30	200	2.400	16,82
TTXEB60060	6,0x60	TX30	200	1.200	19,44
TTXEB60070	6,0x70	TX30	200	1.200	21,76
TTXEB60080	6,0x80	TX30	200	1.200	23,57
TTXEB60090	6,0x90	TX30	100	1.200	27,16
TTXEB60100	6,0 x100	TX30	100	1.200	27,77
TTXEB60110	6,0 x110	TX30	100	1.200	42,93

BICROMATADO

CÓDIGO CODE	MEDIDA SIZE				€ / 100
TTXEB60120	6,0 x120	TX30	100	600	43,56
TTXEB60130	6,0 x130	TX30	100	600	47,83
TTXEB60140	6,0 x140	TX30	100	600	53,32
TTXEB60150	6,0 x150	TX30	100	600	62,22
TTXEB60160	6,0 x160	TX30	100	400	69,34
TTXEB60180	6,0 x180	TX30	100	300	93,84
TTXEB60200	6,0 x200	TX30	100	300	99,91
TTXEB60220	6,0 x220	TX30	100	300	121,59
TTXEB60240	6,0 x240	TX30	100	900	144,53
TTXEB60260	6,0 x260	TX30	100	900	158,01
TTXEB60280	6,0 x280	TX30	100	900	190,84
TTXEB60300	6,0 x300	TX30	100	900	211,28
TTXEB80050	8,0x50	TX40	100	1.200	54,18
TTXEB80060	8,0x60	TX40	100	1.200	55,73
TTXEB80070	8,0x70	TX40	100	1.200	58,56
TTXEB80080	8,0x80	TX40	100	1.200	45,17
TTXEB80090	8,0x90	TX40	100	600	55,13
TTXEB80100	8,0 x100	TX40	100	600	59,83
TTXEB80120	8,0 x120	TX40	100	600	78,31
TTXEB80140	8,0 x140	TX40	100	600	87,38
TTXEB80150	8,0 x150	TX40	100	600	99,78
TTXEB80160	8,0 x160	TX40	100	400	108,78
TTXEB80180	8,0 x180	TX40	100	300	133,16
TTXEB80200	8,0 x200	TX40	100	300	153,00
TTXEB80220	8,0 x220	TX40	100	300	178,63
TTXEB80240	8,0 x240	TX40	50	450	199,49
TTXEB80250	8,0 x250	TX40	50	450	243,80
TTXEB80260	8,0 x260	TX40	50	450	256,33
TTXEB80280	8,0 x280	TX40	50	450	258,81
TTXEB80300	8,0 x300	TX40	50	450	278,32
TTXEB80320	8,0 x320	TX40	50	450	296,90
TTXEB80340	8,0 x340	TX40	50	450	316,36
TTXEB80350	8,0 x350	TX40	50	450	357,34
TTXEB80360	8,0 x360	TX40	50	450	382,82
TTXEB80380	8,0 x380	TX40	50	450	403,05
TTXEB80400	8,0 x400	TX40	50	450	463,64
TTXEB10080	10,0x80	TX40	50	300	106,42
TTXEB10100	10,0 x100	TX40	50	300	114,78
TTXEB10120	10,0 x120	TX40	50	300	115,47
TTXEB10140	10,0 x140	TX40	50	300	139,29
TTXEB10160	10,0 x160	TX40	50	200	162,66
TTXEB10180	10,0 x180	TX40	50	150	211,53
TTXEB10200	10,0 x200	TX40	50	150	266,34
TTXEB10220	10,0 x220	TX40	50	150	280,05
TTXEB10240	10,0 x240	TX40	40	360	344,07
TTXEB10250	10,0 x250	TX40	40	360	427,46
TTXEB10260	10,0 x260	TX40	40	360	435,16
TTXEB10280	10,0 x280	TX40	40	360	476,14
TTXEB10300	10,0 x300	TX40	40	360	501,16
TTXEB10320	10,0 x320	TX40	40	360	558,80
TTXEB10340	10,0 x340	TX40	40	360	590,92
TTXEB10350	10,0 x350	TX40	40	360	649,90
TTXEB10360	10,0 x360	TX40	40	360	653,27
TTXEB10380	10,0 x380	TX40	40	360	678,15
TTXEB10400	10,0 x400	TX40	40	360	722,04



TTXEZ

Tornillo autotaladrante, CABEZA AVELLANADA, huella TX, punta fresada "type 17"



madera
wood



ZINCADO

CÓDIGO CODE	MEDIDA SIZE				€ / 100
TTXEZ30016	3,0x16	TX10	1.000	24.000	2,22
TTXEZ30020	3,0x20	TX10	1.000	24.000	2,29
TTXEZ30025	3,0x25	TX10	500	12.000	2,94
TTXEZ30030	3,0x30	TX10	500	12.000	3,40
TTXEZ30035	3,0x35	TX10	500	12.000	3,45
TTXEZ30040	3,0x40	TX10	500	6.000	3,76
TTXEZ35016	3,5x16	TX15	1.000	24.000	2,56
TTXEZ35020	3,5x20	TX15	1.000	12.000	2,67
TTXEZ35025	3,5x25	TX15	500	12.000	3,33
TTXEZ35030	3,5x30	TX15	500	12.000	3,90
TTXEZ35035	3,5x35	TX15	500	6.000	4,13
TTXEZ35040	3,5x40	TX15	500	6.000	5,00
TTXEZ35045	3,5x45	TX15	200	4.800	5,59
TTXEZ35050	3,5x50	TX15	200	4.800	6,31
TTXEZ35060	3,5x60	TX15	200	2.400	8,90
TTXEZ40016	4,0x16	TX20	500	12.000	2,90
TTXEZ40020	4,0x20	TX20	500	12.000	3,30
TTXEZ40025	4,0x25	TX20	500	12.000	3,73
TTXEZ40030	4,0x30	TX20	500	6.000	4,13
TTXEZ40035	4,0x35	TX20	500	6.000	4,99
TTXEZ40040	4,0x40	TX20	500	6.000	5,47
TTXEZ40045	4,0x45	TX20	500	6.000	6,70
TTXEZ40050	4,0x50	TX20	200	4.800	6,86
TTXEZ40060	4,0x60	TX20	200	2.400	8,83
TTXEZ40070	4,0x70	TX20	200	2.400	10,38
TTXEZ45030	4,5x30	TX25	500	6.000	5,19
TTXEZ45035	4,5x35	TX25	200	4.800	6,31
TTXEZ45040	4,5x40	TX25	200	4.800	6,53
TTXEZ45045	4,5x45	TX25	200	2.400	7,68
TTXEZ45050	4,5x50	TX25	200	2.400	7,83
TTXEZ45060	4,5x60	TX25	200	2.400	10,26
TTXEZ45070	4,5x70	TX25	200	2.400	12,59
TTXEZ45080	4,5x80	TX25	200	2.400	16,60

ZINCADO

CÓDIGO CODE	MEDIDA SIZE				€ / 100
TTXEZ50030	5,0x30	TX25	200	4.800	7,22
TTXEZ50035	5,0x35	TX25	200	4.800	7,75
TTXEZ50040	5,0x40	TX25	200	2.400	8,42
TTXEZ50045	5,0x45	TX25	200	2.400	9,79
TTXEZ50050	5,0x50	TX25	200	2.400	10,57
TTXEZ50060	5,0x60	TX25	200	2.400	13,15
TTXEZ50070	5,0x70	TX25	200	2.400	15,47
TTXEZ50080	5,0x80	TX25	200	1.200	19,73
TTXEZ50090	5,0x90	TX25	100	1.200	19,87
TTXEZ50100	5,0 x100	TX25	100	1.200	22,36
TTXEZ50110	5,0 x110	TX25	100	1.200	34,62
TTXEZ50120	5,0 x120	TX25	100	1.200	29,33
TTXEZ60040	6,0x40	TX30	200	2.400	13,50
TTXEZ60045	6,0x45	TX30	200	2.400	20,85
TTXEZ60050	6,0x50	TX30	200	2.400	16,82
TTXEZ60060	6,0x60	TX30	200	1.200	19,44
TTXEZ60070	6,0x70	TX30	200	1.200	21,76
TTXEZ60080	6,0x80	TX30	200	1.200	23,57
TTXEZ60090	6,0x90	TX30	100	1.200	27,16
TTXEZ60100	6,0 x100	TX30	100	1.200	27,77
TTXEZ60110	6,0 x110	TX30	100	1.200	42,93
TTXEZ60120	6,0 x120	TX30	100	600	43,56
TTXEZ60130	6,0 x130	TX30	100	600	47,83
TTXEZ60140	6,0 x140	TX30	100	600	53,32
TTXEZ60150	6,0 x150	TX30	100	600	62,22
TTXEZ60160	6,0 x160	TX30	100	400	69,34
TTXEZ60180	6,0 x180	TX30	100	300	93,84
TTXEZ60200	6,0 x200	TX30	100	300	99,91
TTXEZ60220	6,0 x220	TX30	100	300	121,59
TTXEZ60240	6,0 x240	TX30	100	900	144,53
TTXEZ60260	6,0 x260	TX30	100	900	158,01
TTXEZ60280	6,0 x280	TX30	100	900	190,84
TTXEZ60300	6,0 x300	TX30	100	900	211,28



TTXE-A2

Tornillo autotaladrante, CABEZA AVELLANADA, huella TX, punta fresada "type 17"
INOX A2 (AISI 304)



INOX (A2)



INOXIDABLE A2

CÓDIGO CODE	MEDIDA SIZE				€ / 100
TTXEI50050	5x50	TX25	200	2.400	27,14
TTXEI50060	5x60	TX25	200	2.400	33,84
TTXEI50070	5x70	TX25	200	2.400	40,16



TTX-AR

ARANDELA CÓNICA para tirafondos TTXE



ZINCADO

CÓDIGO CODE	MEDIDA SIZE			€ / 100
TTXARZ06	M6 (7,5x19,5x4,6)	100	2.400	47,20
TTXARZ08	M8 (8,5x24,5x5,4)	100	2.400	77,62
TTXARZ10	M10 (10,8x30,0x6,4)	100	1.200	103,22

BICROMATADO

CÓDIGO CODE	MEDIDA SIZE			€ / 100
TTXARB06	M6 (7,5x19,5x4,6)	100	2.400	47,20
TTXARB08	M8 (8,5x24,5x5,4)	100	2.400	77,62
TTXARB10	M10 (10,8x30,0x6,4)	100	1.200	103,22

TTX-CAB

Tornillo autotaladrante, **CABEZA ANCHA**, con arandela estampada, huella TX, punta fresada "type 17"

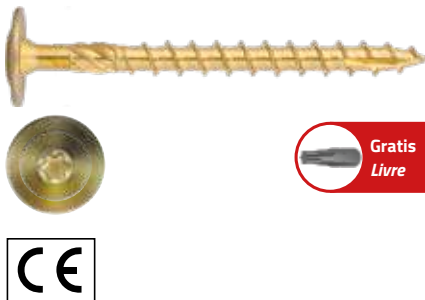

BICROMATADO

CÓDIGO CODE	MEDIDA SIZE				€/ 100
TTXCA60030	6,0x30	TX30	200	2.400	19,85
TTXCA60040	6,0x40	TX30	200	2.400	22,29
TTXCA60050	6,0x50	TX30	200	2.400	24,04
TTXCA60060	6,0x60	TX30	200	1.200	29,70
TTXCA60070	6,0x70	TX30	200	1.200	30,80
TTXCA60080	6,0x80	TX30	200	1.200	31,18
TTXCA60100	6,0x100	TX30	100	1.200	34,70
TTXCA60120	6,0x120	TX30	100	600	51,60
TTXCA60140	6,0x140	TX30	100	600	61,63
TTXCA60160	6,0x160	TX30	100	400	84,44
TTXCA60180	6,0x180	TX30	100	300	106,55
TTXCA60200	6,0x200	TX30	100	300	137,33
TTXCA60220	6,0x220	TX30	100	300	169,20
TTXCA60240	6,0x240	TX30	100	900	201,98
TTXCA60260	6,0x260	TX30	100	900	228,33
TTXCA60280	6,0x280	TX30	100	900	257,25
TTXCA60300	6,0x300	TX30	100	900	286,17
TTXCA80050	8,0x50	TX40	100	1.200	61,07
TTXCA80060	8,0x60	TX40	100	600	72,53
TTXCA80070	8,0x70	TX40	100	600	79,29
TTXCA80080	8,0x80	TX40	100	600	58,98
TTXCA80100	8,0x100	TX40	100	600	67,52
TTXCA80120	8,0x120	TX40	100	300	91,40
TTXCA80140	8,0x140	TX40	100	300	97,77
TTXCA80160	8,0x160	TX40	100	300	138,76

BICROMATADO

CÓDIGO CODE	MEDIDA SIZE				€/ 100
TTXCA80180	8,0x180	TX40	100	300	144,46
TTXCA80200	8,0x200	TX40	100	300	168,77
TTXCA80220	8,0x220	TX40	100	300	191,23
TTXCA80240	8,0x240	TX40	50	450	217,75
TTXCA80260	8,0x260	TX40	50	450	255,02
TTXCA80280	8,0x280	TX40	50	100	257,05
TTXCA80300	8,0x300	TX40	50	100	292,67
TTXCA80320	8,0x320	TX40	25	150	367,61
TTXCA80360	8,0x360	TX40	50	150	408,72
TTXCA80400	8,0x400	TX40	50	150	453,95
TTXCA10080	10,0x80	TX40	50	300	129,96
TTXCA10100	10,0x100	TX40	50	300	142,27
TTXCA10120	10,0x120	TX40	50	300	173,93
TTXCA10140	10,0x140	TX40	50	300	196,41
TTXCA10160	10,0x160	TX40	50	200	225,81
TTXCA10180	10,0x180	TX40	50	150	286,63
TTXCA10200	10,0x200	TX40	50	150	287,30
TTXCA10220	10,0x220	TX40	50	150	408,27
TTXCA10240	10,0x240	TX40	40	80	357,28
TTXCA10260	10,0x260	TX40	40	80	496,84
TTXCA10280	10,0x280	TX40	40	80	436,04
TTXCA10300	10,0x300	TX40	40	80	598,49
TTXCA10320	10,0x320	TX40	25	150	590,11
TTXCA10360	10,0x360	TX40	25	150	655,14
TTXCA10400	10,0x400	TX40	25	150	722,87

TT-BR

Tornillo autotaladrante, **CABEZA AVELLANADA**, huella TX



ZINCADO

CÓDIGO CODE	MEDIDA SIZE				€/ 100
* TTBRZ40030	4,0x30	TX20	500	6.000	9,75
* TTBRZ40035	4,0x35	TX20	500	6.000	10,76
* TTBRZ40040	4,0x40	TX20	500	6.000	12,11
* TTBRZ40045	4,0x45	TX20	200	4.800	13,96
* TTBRZ40050	4,0x50	TX20	200	4.800	13,56
* TTBRZ40060	4,0x60	TX20	200	2.400	19,34
* TTBRZ40070	4,0x70	TX20	200	2.400	21,31

(*) HASTA FINAL DE EXISTENCIAS

ZINCADO

CÓDIGO CODE	MEDIDA SIZE				€/ 100
* TTBRZ50050	5,0x50	TX25	200	2.400	23,67
* TTBRZ50060	5,0x60	TX25	200	2.400	28,55
* TTBRZ50070	5,0x70	TX25	200	2.400	31,11
* TTBRZ50080	5,0x80	TX25	200	2.400	35,97
* TTBRZ50090	5,0x90	TX25	100	1.200	41,84
* TTBRZ50100	5,0x100	TX25	100	1.200	51,35

DIN-7505-B / TPOR

Tirafondo, **CABEZA ALOMADA**, Pozidriv, filete 40°, lubricado



BICROMATADO

CÓDIGO CODE	MEDIDA SIZE				€/ 100
TPOR30016	3,0x16	PZ1	1.000	24.000	1,90
TPOR30020	3,0x20	PZ1	1.000	24.000	1,95
TPOR35016	3,5x16	PZ2	1.000	24.000	2,14
TPOR35020	3,5x20	PZ2	1.000	12.000	2,71
TPOR35025	3,5x25	PZ2	1.000	12.000	2,77
TPOR35030	3,5x30	PZ2	1.000	12.000	3,06
TPOR35035	3,5x35	PZ2	500	6.000	3,21
TPOR40016	4,0x16	PZ2	1.000	16.000	2,97
TPOR40020	4,0x20	PZ2	1.000	12.000	3,16
TPOR40025	4,0x25	PZ2	1.000	12.000	3,52
TPOR40030	4,0x30	PZ2	500	6.000	3,90
TPOR40035	4,0x35	PZ2	500	6.000	4,22
TPOR40040	4,0x40	PZ2	500	6.000	4,80
TPOR40050	4,0x50	PZ2	250	3.000	6,22

BICROMATADO

CÓDIGO CODE	MEDIDA SIZE				€/ 100
TPOR45016	4,5x16	PZ2	500	12.000	3,90
TPOR45020	4,5x20	PZ2	500	12.000	4,06
TPOR45025	4,5x25	PZ2	500	6.000	4,71
TPOR45030	4,5x30	PZ2	500	6.000	5,39
TPOR45035	4,5x35	PZ2	500	6.000	6,10
TPOR45040	4,5x40	PZ2	500	3.000	6,16
TPOR45045	4,5x45	PZ2	250	3.000	7,05
TPOR50020	5,0x20	PZ2	500	6.000	5,38
TPOR50030	5,0x30	PZ2	250	6.000	6,31
TPOR50040	5,0x40	PZ2	250	3.000	7,30
TPOR50050	5,0x50	PZ2	250	3.000	9,30

DIN-7505-A / TTOB

Tirafondo, CABEZA AVELLANADA, huella TX, filete 40°, lubricado



madera
wood

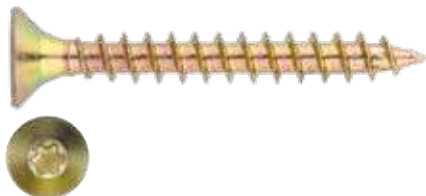

BICROMATADO

CÓDIGO CODE	MEDIDA SIZE				€ / 100
TTOB30025	3,0x25	TX10	1.000	12.000	1,88
TTOB30030	3,0x30	TX10	1.000	12.000	2,04
TTOB35016	3,5x16	TX15	1.000	24.000	1,92
TTOB35020	3,5x20	TX15	1.000	12.000	1,98
TTOB35025	3,5x25	TX15	1.000	12.000	2,07
TTOB35030	3,5x30	TX15	1.000	12.000	2,38
TTOB35040	3,5x40	TX15	500	6.000	3,25
TTOB35050	3,5x50	TX15	250	3.000	3,88
TTOB40020	4,0x20	TX20	1.000	12.000	2,27
TTOB40025	4,0x25	TX20	1.000	12.000	2,83
TTOB40030	4,0x30	TX20	500	6.000	3,18
TTOB40035	4,0x35	TX20	500	6.000	3,65
TTOB40040	4,0x40	TX20	500	6.000	3,83
TTOB40045	4,0x45	TX20	500	3.000	4,55
TTOB40050	4,0x50	TX20	250	3.000	5,15
TTOB40060	4,0x60	TX20	250	3.000	6,00
TTOB40070	4,0x70	TX20	250	1.500	7,48
TTOB45030	4,5x30	TX20	500	6.000	3,89
TTOB45035	4,5x35	TX20	500	6.000	4,67
TTOB45040	4,5x40	TX20	500	3.000	4,97
TTOB45045	4,5x45	TX20	250	3.000	5,76
TTOB45050	4,5x50	TX20	250	3.000	6,03
TTOB45060	4,5x60	TX20	250	3.000	7,69
TTOB45070	4,5x70	TX20	250	1.500	8,94

BICROMATADO

CÓDIGO CODE	MEDIDA SIZE				€ / 100
TTOB50030	5,0x30	TX25	250	6.000	5,06
TTOB50035	5,0x35	TX25	250	3.000	5,89
TTOB50040	5,0x40	TX25	250	3.000	6,25
TTOB50045	5,0x45	TX25	250	3.000	7,24
TTOB50050	5,0x50	TX25	250	3.000	7,98
TTOB50060	5,0x60	TX25	250	1.500	9,07
TTOB50070	5,0x70	TX25	100	1.200	11,45
TTOB50080	5,0x80	TX25	100	1.200	13,22
TTOB50090	5,0x90	TX25	100	1.200	14,66
TTOB50100	5,0x100	TX25	100	1.200	15,88
TTOB50120	5,0x120	TX25	100	1.200	21,12
TTOB60060	6,0x60	TX30	250	1.500	13,02
TTOB60070	6,0x70	TX30	100	1.200	15,66
TTOB60080	6,0x80	TX30	100	1.200	17,44
TTOB60090	6,0x90	TX30	100	1.200	20,23
TTOB60100	6,0x100	TX30	100	1.200	22,22
TTOB60110	6,0x110	TX30	100	600	27,90
TTOB60120	6,0x120	TX30	100	600	29,19
TTOB60130	6,0x130	TX30	100	600	33,01
TTOB60140	6,0x140	TX30	100	600	35,19
TTOB60150	6,0x150	TX30	100	600	39,82
TTOB60160	6,0x160	TX30	100	300	47,15
TTOB60180	6,0x180	TX30	100	300	60,99
TTOB60200	6,0x200	TX30	100	300	74,93
TTOB60220	6,0x220	TX30	100	300	82,90



P.202



SOLICITAR FICHA TÉCNICA

DIN-7505-A / TPOB

Tirafondo, CABEZA AVELLANADA, huella Pozidriv, filete 40°, lubricado



madera
wood



BICROMATADO

CÓDIGO CODE	MEDIDA SIZE				€ / 100
TPOB25010	2,5x10	PZ1	1.000	45.000	1,10
TPOB25012	2,5x12	PZ1	1.000	45.000	1,11
TPOB25016	2,5x16	PZ1	1.000	45.000	1,23
TPOB25020	2,5x20	PZ1	1.000	24.000	1,38
TPOB25025	2,5x25	PZ1	1.000	24.000	1,51
TPOB30012	3,0x12	PZ1	1.000	45.000	0,98
TPOB30016	3,0x16	PZ1	1.000	24.000	1,07
TPOB30020	3,0x20	PZ1	1.000	24.000	1,22
TPOB30025	3,0x25	PZ1	1.000	12.000	1,40
TPOB30030	3,0x30	PZ1	1.000	12.000	1,56
TPOB30040	3,0x40	PZ1	1.000	6.000	2,14
TPOB35010	3,5x10	PZ2	1.000	45.000	1,52
TPOB35012	3,5x12	PZ2	1.000	24.000	1,54
TPOB35016	3,5x16	PZ2	1.000	24.000	1,20
TPOB35020	3,5x20	PZ2	1.000	12.000	1,46
TPOB35025	3,5x25	PZ2	1.000	12.000	1,61
TPOB35030	3,5x30	PZ2	1.000	12.000	1,86
TPOB35035	3,5x35	PZ2	500	6.000	2,22
TPOB35040	3,5x40	PZ2	500	6.000	2,39
TPOB35050	3,5x50	PZ2	250	3.000	3,12
TPOB40016	4,0x16	PZ2	1.000	16.000	1,52
TPOB40020	4,0x20	PZ2	1.000	12.000	1,81
TPOB40025	4,0x25	PZ2	1.000	12.000	2,02
TPOB40030	4,0x30	PZ2	500	6.000	2,36
TPOB40035	4,0x35	PZ2	500	6.000	2,67
TPOB40040	4,0x40	PZ2	500	6.000	2,80
TPOB40045	4,0x45	PZ2	500	3.000	3,41
TPOB40050	4,0x50	PZ2	250	3.000	3,77
TPOB40060	4,0x60	PZ2	250	3.000	4,32
TPOB40070	4,0x70	PZ2	250	1.500	5,48
TPOB45020	4,5x20	PZ2	500	12.000	2,21
TPOB45025	4,5x25	PZ2	500	6.000	2,66
TPOB45030	4,5x30	PZ2	500	6.000	2,96
TPOB45035	4,5x35	PZ2	500	6.000	3,35

BICROMATADO

CÓDIGO CODE	MEDIDA SIZE				€ / 100
TPOB45040	4,5x40	PZ2	500	3.000	3,74
TPOB45045	4,5x45	PZ2	250	3.000	4,28
TPOB45050	4,5x50	PZ2	250	3.000	4,60
TPOB45060	4,5x60	PZ2	250	3.000	5,60
TPOB45070	4,5x70	PZ2	250	1.500	6,80
TPOB45080	4,5x80	PZ2	100	1.200	8,14
TPOB50020	5,0x20	PZ2	500	6.000	2,78
TPOB50025	5,0x25	PZ2	500	6.000	3,35
TPOB50030	5,0x30	PZ2	250	6.000	3,68
TPOB50035	5,0x35	PZ2	250	3.000	4,38
TPOB50040	5,0x40	PZ2	250	3.000	4,71
TPOB50045	5,0x45	PZ2	250	3.000	5,24
TPOB50050	5,0x50	PZ2	250	3.000	5,50
TPOB50060	5,0x60	PZ2	250	1.500	6,75
TPOB50070	5,0x70	PZ2	100	1.200	8,23
TPOB50080	5,0x80	PZ2	100	1.200	9,34
TPOB50090	5,0x90	PZ2	100	1.200	11,44
TPOB50100	5,0x100	PZ2	100	1.200	12,60
TPOB50120	5,0x120	PZ2	100	1.200	18,37
TPOB60040	6,0x40	PZ3	250	3.000	7,03
TPOB60050	6,0x50	PZ3	250	1.500	8,30
TPOB60060	6,0x60	PZ3	250	1.500	9,66
TPOB60070	6,0x70	PZ3	100	1.200	12,12
TPOB60080	6,0x80	PZ3	100	1.200	13,59
TPOB60090	6,0x90	PZ3	100	1.200	15,25
TPOB60100	6,0x100	PZ3	100	1.200	16,54
TPOB60110	6,0x110	PZ3	100	600	19,98
TPOB60120	6,0x120	PZ3	100	600	21,48
TPOB60130	6,0x130	PZ3	100	600	26,63
TPOB60140	6,0x140	PZ3	100	600	28,05
TPOB60150	6,0x150	PZ3	100	600	31,33
TPOB60160	6,0x160	PZ3	100	300	33,42
TPOB60180	6,0x180	PZ3	100	300	47,17
TPOB60200	6,0x200	PZ3	100	300	61,41
TPOB60220	6,0x220	PZ3	100	300	95,60



P.201



SOLICITAR FICHA TÉCNICA

DIN-7505-A / TPOZ

Tirafondo, CABEZA AVELLANADA, huella Pozidriv, filete 40°, lubricado



madera
wood



SOLICITAR FICHA TÉCNICA



P.201

ZINCADO

CÓDIGO CODE	MEDIDA SIZE				€ / 100
TPOZ25010	2,5x10	PZ1	1.000	45.000	1,10
TPOZ25012	2,5x12	PZ1	1.000	45.000	1,11
TPOZ25016	2,5x16	PZ1	1.000	45.000	1,23
TPOZ25020	2,5x20	PZ1	1.000	24.000	1,38
TPOZ25025	2,5x25	PZ1	1.000	24.000	1,51
TPOZ30012	3,0x12	PZ1	1.000	45.000	0,98
TPOZ30016	3,0x16	PZ1	1.000	24.000	1,07
TPOZ30020	3,0x20	PZ1	1.000	24.000	1,22
TPOZ30025	3,0x25	PZ1	1.000	12.000	1,40
TPOZ30030	3,0x30	PZ1	1.000	12.000	1,56
TPOZ30040	3,0x40	PZ1	1.000	6.000	2,14
TPOZ35010	3,5x10	PZ2	1.000	45.000	1,52
TPOZ35012	3,5x12	PZ2	1.000	24.000	1,54
TPOZ35016	3,5x16	PZ2	1.000	24.000	1,20
TPOZ35020	3,5x20	PZ2	1.000	12.000	1,46
TPOZ35025	3,5x25	PZ2	1.000	12.000	1,61
TPOZ35030	3,5x30	PZ2	1.000	12.000	1,86
TPOZ35035	3,5x35	PZ2	500	6.000	2,22
TPOZ35040	3,5x40	PZ2	500	6.000	2,39
TPOZ35050	3,5x50	PZ2	250	3.000	3,12
TPOZ40016	4,0x16	PZ2	1.000	16.000	1,52
TPOZ40020	4,0x20	PZ2	1.000	12.000	1,81
TPOZ40025	4,0x25	PZ2	1.000	12.000	2,02
TPOZ40030	4,0x30	PZ2	500	6.000	2,36
TPOZ40035	4,0x35	PZ2	500	6.000	2,67
TPOZ40040	4,0x40	PZ2	500	6.000	2,80
TPOZ40045	4,0x45	PZ2	500	3.000	3,41
TPOZ40050	4,0x50	PZ2	250	3.000	3,77
TPOZ40060	4,0x60	PZ2	250	3.000	4,32
TPOZ40070	4,0x70	PZ2	250	1.500	5,48

ZINCADO

CÓDIGO CODE	MEDIDA SIZE				€ / 100
TPOZ45020	4,5x20	PZ2	500	12.000	2,21
TPOZ45025	4,5x25	PZ2	500	6.000	2,66
TPOZ45030	4,5x30	PZ2	500	6.000	2,96
TPOZ45035	4,5x35	PZ2	500	6.000	3,35
TPOZ45040	4,5x40	PZ2	500	3.000	3,74
TPOZ45045	4,5x45	PZ2	250	3.000	4,28
TPOZ45050	4,5x50	PZ2	250	3.000	4,60
TPOZ45060	4,5x60	PZ2	250	3.000	5,60
TPOZ45070	4,5x70	PZ2	250	1.500	6,80
TPOZ45080	4,5x80	PZ2	100	1.200	8,14
TPOZ50020	5,0x20	PZ2	500	6.000	2,78
TPOZ50025	5,0x25	PZ2	500	6.000	3,35
TPOZ50030	5,0x30	PZ2	250	6.000	3,68
TPOZ50035	5,0x35	PZ2	250	3.000	4,38
TPOZ50040	5,0x40	PZ2	250	3.000	4,71
TPOZ50045	5,0x45	PZ2	250	3.000	5,24
TPOZ50050	5,0x50	PZ2	250	3.000	5,50
TPOZ50060	5,0x60	PZ2	250	1.500	6,75
TPOZ50070	5,0x70	PZ2	100	1.200	8,23
TPOZ50080	5,0x80	PZ2	100	1.200	9,34
TPOZ50090	5,0x90	PZ2	100	1.200	11,44
TPOZ50100	5,0 x100	PZ2	100	1.200	12,60
TPOZ50120	5,0 x120	PZ2	100	1.200	18,37
TPOZ60040	6,0x40	PZ3	250	3.000	7,03
TPOZ60050	6,0x50	PZ3	250	1.500	8,30
TPOZ60060	6,0x60	PZ3	250	1.500	9,66
TPOZ60070	6,0x70	PZ3	100	1.200	12,12
TPOZ60080	6,0x80	PZ3	100	1.200	13,59
TPOZ60090	6,0x90	PZ3	100	1.200	15,25
TPOZ60100	6,0x100	PZ3	100	1.200	16,54
TPOZ60110	6,0x110	PZ3	100	600	19,98
TPOZ60120	6,0x120	PZ3	100	600	21,48
TPOZ60130	6,0x130	PZ3	100	600	26,63
TPOZ60140	6,0x140	PZ3	100	600	28,05
TPOZ60150	6,0x150	PZ3	100	600	31,33
TPOZ60160	6,0x160	PZ3	100	300	33,42
TPOZ60180	6,0x180	PZ3	100	300	47,17
TPOZ60200	6,0x200	PZ3	100	300	61,41
TPOZ60220	6,0x220	PZ3	100	300	95,60

NEW
NEW
NEW
NEW
NEW
NEW
NEW
NEW

DIN-7505-A / TPOI

Tirafondo, CABEZA AVELLANADA, huella Pozidriv, filete 40°, lubricado
INOX A2 (AISI 304)



madera
wood



INOXIDABLE A2

CÓDIGO CODE	MEDIDA SIZE				€ / 100
TPOI23016	3,0x16	PZ1	200	9.000	4,11
TPOI23025	3,0x25	PZ1	200	9.000	5,26
TPOI23520	3,5x20	PZ2	200	9.000	6,93
TPOI23525	3,5x25	PZ2	200	9.000	7,49
TPOI23530	3,5x30	PZ2	200	9.000	9,13
TPOI23540	3,5x40	PZ2	200	9.000	12,98
TPOI24030	4,0x30	PZ2	200	9.000	11,10
TPOI24040	4,0x40	PZ2	200	4.800	13,10
TPOI24050	4,0x50	PZ2	200	4.800	20,56

INOXIDABLE A2

CÓDIGO CODE	MEDIDA SIZE				€ / 100
TPOI24530	4,5x30	PZ2	200	9.000	13,03
TPOI24540	4,5x40	PZ2	200	9.000	20,81
TPOI24550	4,5x50	PZ2	200	2.400	21,00
TPOI25040	5,0x40	PZ2	200	2.400	22,30
TPOI25050	5,0x50	PZ2	200	2.400	26,25
TPOI25060	5,0x60	PZ2	200	2.400	29,14
TPOI25070	5,0x70	PZ2	200	2.400	35,78

TAPAS PVC
DISPONIBLE, VER PÁGINA:
P.132



TPL

Tornillo para placas de cartón-yeso, **CABEZA TROMPETA**, rosca doble hilo, punta S



yeso laminado
plasterboard



Punta alfiler



FOSFATADO

CÓDIGO CODE	MEDIDA SIZE		CAP.			€ / 100
TPLN35019	3,5x19	PH2	0,60	1.000	12.000	2,27
TPLN35025	3,5x25	PH2	0,60	1.000	12.000	2,06
TPLN35035	3,5x35	PH2	0,60	1.000	6.000	2,65
TPLN35045	3,5x45	PH2	0,60	500	6.000	3,24
TPLN35055	3,5x55	PH2	0,60	500	3.000	4,36
TPLN39025	3,9x25	PH2	0,60	1.000	12.000	2,55
TPLN39038	3,9x38	PH2	0,60	1.000	6.000	3,59
TPLN39048	3,9x48	PH2	0,60	500	3.000	4,52
TPLN39058	3,9x58	PH2	0,60	500	3.000	5,41
TPLN42065	4,2x65	PH2	0,60	500	3.000	8,07



ZINCADO

CÓDIGO CODE	MEDIDA SIZE		CAP.			€ / 100
TPLZ42075	4,2x75	PH2	0,60	500	2.000	10,73
TPLZ48090	4,8x90	PH2	0,60	500	2.000	18,03
TPLZ48100	4,8x100	PH2	0,60	250	1.000	22,46
TPLZ48110	4,8x110	PH2	0,60	250	1.000	24,84
TPLZ48120	4,8x120	PH2	0,60	250	1.000	27,51
TPLZ48130	4,8x130	PH2	0,60	250	1.000	30,22



CUBO DE PLÁSTICO



TORNILLO TPL EN CUBO DE PLÁSTICO

CÓDIGO CODE	MEDIDA SIZE		CAP.		€ / 1
TPLN35025BP	3,5x25	PH2	0,60	4.000	82,38
TPLN35035BP	3,5x35	PH2	0,60	3.000	79,22

TPL-CI

Tornillo para placas de cartón-yeso, **ENCINTADO**



yeso laminado
plasterboard



FOSFATADO

CÓDIGO CODE	MEDIDA SIZE	Nº PIEZAS TIRA / PIECES PER STRIP			€ / 100
TPLCI35025	3,5x25	50	1.000	9.000	6,09
TPLCI35035	3,5x35	50	1.000	9.000	6,89

TBPL

Tornillo autotaladrante para placas de cartón-yeso, **CABEZA TROMPETA**



yeso laminado
plasterboard

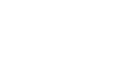

FOSFATADO

CÓDIGO CODE	MEDIDA SIZE		CAP.			€ / 100
TBPLN3525	3,5x25	PH2	3,00	1.000	12.000	2,84
TBPLN3535	3,5x35	PH2	3,00	1.000	6.000	3,61
TBPLN3545	3,5x45	PH2	3,00	500	6.000	4,35

TPRA

Tornillo para placas de cartón-yeso, rosca paso ancho, **CABEZA TROMPETA**



yeso laminado
plasterboard



SOLICITAR
FICHA TÉCNICA

FOSFATADO

CÓDIGO CODE	MEDIDA SIZE				€/ 100
TPRA39025	3,9x25	PH2	1.000	12.000	3,22
TPRA39035	3,9x35	PH2	1.000	6.000	4,08
TPRA39045	3,9x45	PH2	500	3.000	5,17
TPRA39055	3,9x55	PH2	500	3.000	5,62
TPRA48035	4,8x35	PH2	1.000	6.000	5,07

TPCA

Tornillo para placas de cartón-yeso, **CABEZA ANCHA**



yeso laminado
plasterboard



SOLICITAR
FICHA TÉCNICA

ZINCADO

CÓDIGO CODE	MEDIDA SIZE				€/ 100
TPCA4213	4,2x13	PH2	1.000	12.000	3,54
TPCA4216	4,2x16	PH2	1.000	12.000	3,84
TPCA4219	4,2x19	PH2	1.000	12.000	4,14
TPCA4225	4,2x25	PH2	1.000	6.000	4,71

MOR

MORDAZA para viga IPN



viga IPN
beam IPN



SOLICITAR
FICHA TÉCNICA

ZINCADO

CÓDIGO CODE	MEDIDA SIZE	↓ MAX. ↑			€/ 100
MOR09	Ø 9 PASANTE	20	50	150	327,28
MOR11	Ø 11 PASANTE	21	50	150	382,47
MOR13	Ø 13 PASANTE	26	-	50	593,80
MORM06	M-06 ROSCADO	20	50	200	304,48
MORM08	M-08 ROSCADO	20	50	200	327,28
MORM10	M-10 ROSCADO	21	50	150	382,47
MORM12	M-12 ROSCADO	26	-	50	593,80

TBH

BOCAS / VASOS hexagonales magnéticas



CÓDIGO CODE	MEDIDA SIZE				€/ 100
TBH006	1/4" - 6 mm	6	5	240	404,70
TBH007	1/4" - 7 mm	7	5	240	404,70
TBH008	1/4" - 8 mm	8	5	240	404,70
TBH010	1/4" - 10 mm	10	5	240	404,70

TPPM

PORTA PUNTAS magnético 1/4"



CÓDIGO CODE	MEDIDA SIZE				€/ 100
TPPM014	1/4"x60	1/4"	5	240	513,39

TPU

Puntas de atornillar, POZIDRIV - PHILLIPS - TORX

PHILLIPS



CÓDIGO CODE	MEDIDA SIZE				€ / 100
TPUPHC01	Nº 1 / 25	PH1	25	1.200	66,19
TPUPHC02	Nº 2 / 25	PH2	25	1.200	66,19
TPUPHC03	Nº 3 / 25	PH3	25	1.200	66,19

PHILLIPS



CÓDIGO CODE	MEDIDA SIZE				€ / 100
TPUPHL01	Nº 1 / 50	PH1	25	1.200	106,18
TPUPHL02	Nº 2 / 50	PH2	25	1.200	106,18
TPUPHL03	Nº 3 / 50	PH3	25	1.200	106,18

POZIDRIV



CÓDIGO CODE	MEDIDA SIZE				€ / 100
TPUPOC01	Nº 1 / 25	PZ1	25	1.200	66,19
TPUPOC02	Nº 2 / 25	PZ2	25	1.200	66,19
TPUPOC03	Nº 3 / 25	PZ3	25	1.200	66,19

POZIDRIV



CÓDIGO CODE	MEDIDA SIZE				€ / 100
TPUPOL01	Nº 1 / 50	PZ1	25	1.200	106,18
TPUPOL02	Nº 2 / 50	PZ2	25	1.200	106,18
TPUPOL03	Nº 3 / 50	PZ3	25	1.200	106,18

TORX



CÓDIGO CODE	MEDIDA SIZE				€ / 100
TPUTOC08	Nº 8 / 25	T8	25	1.200	74,57
TPUTOC10	Nº 10 / 25	T10	25	1.200	74,57
TPUTOC15	Nº 15 / 25	T15	25	1.200	74,57
TPUTOC20	Nº 20 / 25	T20	25	1.200	74,57

TORX



CÓDIGO CODE	MEDIDA SIZE				€ / 100
TPUTOC25	Nº 25 / 25	T25	25	1.200	74,57
TPUTOC27	Nº 27 / 25	T27	25	1.200	74,57
TPUTOC30	Nº 30 / 25	T30	25	1.200	74,57
TPUTOC40	Nº 40 / 25	T40	25	1.200	74,57

TTC

TAPA TORNILLOS de PVC, adhesivo Ø 13



CÓDIGO CODE	MEDIDA SIZE			€ / 100
TTCBL	BLANCO / WHITE	1.000	24.000	3,64
TTCNE	NEGRO / BLACK	1.000	24.000	3,64
TTCGR	GRIS / GREY	1.000	24.000	3,64
TTCGM	GRIS METAL / GREY METAL	1.000	24.000	3,64
TTCBE	BEIGE	1.000	24.000	3,64
TTCP	PINO / PINE	1.000	24.000	3,64
TTCHA	HAYA / BEECH	1.000	24.000	3,64
TTCRO	ROBLE / OAK	1.000	24.000	3,64
TTCCE	CEREZO / CHERRY	1.000	24.000	3,64
TTCSA	SAPELLY	1.000	24.000	3,64
TTCNO	NOGAL / WALNUT	1.000	24.000	3,64
TTCL0	TEXTIL LINO-0 / LINEN TEXTILE-0	1.000	24.000	3,64
TTCL1	TEXTIL LINO-1 / LINEN TEXTILE-1	1.000	24.000	3,64
TTCL3	TEXTIL LINO-3 / LINEN TEXTILE-3	1.000	24.000	3,64
TTCGMR	GRIS METAL RUGOSO / ROUGH METAL GRAY	1.000	24.000	3,64
TTCANT	ANTRACITA / ANTHRACITE	1.000	24.000	3,64



TORNILLERÍA NORMALIZADA

Tuerca DIN-934 TUERCA HEXAGONAL



ZINCADO

CÓDIGO CODE	MEDIDA SIZE	PASO P	HEXÁGONO ENTRE CARAS			€ / 100
TS934Z04	M-4	0,70	7	1.000	45.000	1,15
TS934Z05	M-5	0,80	8	500	12.000	1,46
TS934Z06	M-6	1	10	500	12.000	2,26
TS934Z08	M-8	1,25	13	250	6.000	4,39
TS934Z10	M-10	1,50	17	250	3.000	9,73
TS934Z12	M-12	1,75	19	250	1.500	14,58
TS934Z14	M-14	2	22	100	1.200	22,07
TS934Z16	M-16	2	24	100	600	31,19
TS934Z18	M-18	2,5	27	100	600	45,47
TS934Z20	M-20	2,5	30	50	600	54,61
TS934Z22	M-22	2,5	32	50	300	81,47
TS934Z24	M-24	3	36	25	300	119,21
TS934Z27	M-27	3	41	25	150	182,98
TS934Z30	M-30	3,5	46	25	150	242,98
TS934Z33	M-33	3,5	50	10	120	350,03
TS934Z36	M-36	4	55	10	60	426,17

Tuerca DIN-985 TUERCA AUTOBLOCANTE



ZINCADO

CÓDIGO CODE	MEDIDA SIZE	PASO P	HEXÁGONO ENTRE CARAS			€ / 100
TS985Z04	M-4	0,7	7	500	12.000	2,14
TS985Z05	M-5	0,8	8	500	12.000	2,29
TS985Z06	M-6	1	10	500	12.000	3,19
TS985Z08	M-8	1,25	13	250	6.000	5,69
TS985Z10	M-10	1,50	17	250	3.000	12,61
TS985Z12	M-12	1,75	19	100	1.200	19,85
TS985Z14	M-14	2	22	100	1.200	33,57
TS985Z16	M-16	2	24	50	600	40,92
TS985Z18	M-18	2,5	27	50	600	67,70
TS985Z20	M-20	2,5	30	25	300	85,12
TS985Z24	M-24	3	36	25	300	167,98

Varilla DIN-975 VARILLA ROSCADA, Calidad 4.8



LONGITUD 1 METRO / ZINCADO

CÓDIGO CODE	MEDIDA SIZE	←mm→	PASO P		€ / 100
NEW TS975Z532	5/32 w.	1.000	-	100	140,08
TS975Z04	M-4	1.000	0,7	100	135,83
TS975Z05	M-5	1.000	0,8	100	189,70
TS975Z06	M-6	1.000	1	100	184,31
TS975Z08	M-8	1.000	1,25	50	271,68
TS975Z10	M-10	1.000	1,50	25	442,14
TS975Z12	M-12	1.000	1,75	20	612,09
TS975Z14	M-14	1.000	2	10	893,31
TS975Z16	M-16	1.000	2	10	1.213,41
TS975Z18	M-18	1.000	2,5	10	1.503,29
TS975Z20	M-20	1.000	2,5	5	2.074,67
TS975Z22	M-22	1.000	2,5	5	2.361,44
TS975Z24	M-24	1.000	3	5	2.964,52
TS975Z27	M-27	1.000	3	5	3.728,79
TS975Z30	M-30	1.000	3,5	3	4.658,00
TS975Z33	M-33	1.000	3,5	2	6.396,11
TS975Z36	M-36	1.000	4	2	7.533,76

LONGITUD 2 METROS / ZINCADO

CÓDIGO CODE	MEDIDA SIZE	←mm→	PASO P		€ / 100
TS975Z2M06	M-6	2.000	1	50	361,88
NEW TS975Z2M08	M-8	2.000	1,25	50	561,15

TORNILLERÍA NORMALIZADA

Varilla DIN-975

VARILLA ROSCADA, Calidad 8.8



ZINCADO

CÓDIGO CODE	MEDIDA SIZE	←mm→	PASO P		€/ 100
91091	M-6	1.000	1	100	217,39
91092	M-8	1.000	1,25	50	331,41
91093	M-10	1.000	1,50	25	504,14
91094	M-12	1.000	1,72	20	696,55
91095	M-16	1.000	2	10	1.311,42
91108	M-20	1.000	2,50	10	2.148,67

Arandela DIN-125

ARANDELA PLANA



ZINCADO



CÓDIGO CODE	MEDIDA SIZE	ESPESOR THICKNESS	Ø INT - Ø EXT			€/ 100
TS125Z04	M-4	0,8	4,3 - 9,0	1.000	45.000	0,90
TS125Z05	M-5	1	5,3 - 10,0	1.000	45.000	1,13
TS125Z06	M-6	1,6	6,4 - 12,0	500	22.500	1,66
TS125Z08	M-8	1,6	8,4 - 16,0	250	11.250	2,97
TS125Z10	M-10	2	10,5 - 20,0	250	6.000	5,34
TS125Z12	M-12	2,5	13,0 - 24,0	250	3.000	8,79
TS125Z14	M-14	2,5	15,0 - 28,0	200	2.400	11,29
TS125Z16	M-16	3	17,0 - 30,0	100	2.400	14,41
TS125Z18	M-18	3	19,0 - 34,0	100	2.400	18,97
TS125Z20	M-20	3	21,0 - 37,0	50	1.200	23,15
TS125Z22	M-22	3	23,0 - 39,0	50	1.200	36,48
TS125Z24	M-24	4	25,0 - 44,0	50	600	49,42
TS125Z27	M-27	4	28,0 - 50,0	50	600	67,22
TS125Z30	M-30	4	31,0 - 56,0	50	300	89,44
TS125Z33	M-33	5	34,0 - 60,0	50	300	140,03
TS125Z36	M-36	5	37,0 - 66,0	25	300	188,77

Arandela DIN-9021

ARANDELA ANCHA



ZINCADO

CÓDIGO CODE	MEDIDA SIZE	ESPESOR THICKNESS	Ø INT - Ø EXT			€/ 100
TS9021Z04	M-4	1	4,3 - 12,0	500	12.000	1,39
TS9021Z05	M-5	1,2	5,3 - 15,0	500	12.000	2,00
TS9021Z06	M-6	1,6	6,4 - 18,0	500	12.000	3,06
TS9021Z08	M-8	2	8,4 - 24,0	200	4.800	7,30
TS9021Z10	M-10	2,5	10,5 - 30,0	100	2.400	12,83
TS9021Z12	M-12	3	13,0 - 37,0	100	1.200	26,16
TS9021Z14	M-14	3	15,0 - 44,0	100	1.200	36,55
TS9021Z16	M-16	3	17,0 - 50,0	50	600	44,16
TS9021Z18	M-18	4	20,0 - 56,0	50	600	81,02
TS9021Z20	M-20	4	22,0 - 60,0	25	300	88,11
TS9021Z22	M-22	5	24,0 - 66,0	25	300	170,13
TS9021Z24	M-24	5	26,0 - 72,0	25	150	193,62

ALCAYATAS Y PUNTAS



madera
wood



SOLICITAR
FICHA TÉCNICA

HA HEMBRILLA ABIERTA



P. 204

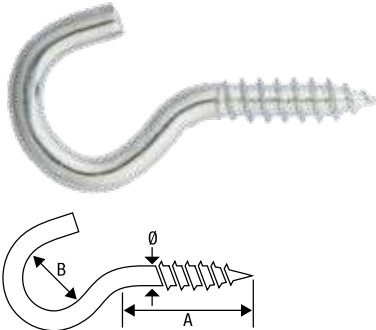

ZINCADO

CÓDIGO CODE	MEDIDA SIZE	A	B	Ø	ROSCA THREAD			€/ 100
HA14025	14x25	8	6	1,90	6	500	22.500	2,81
HA16030	16x30	10	6,5	2,00	8	300	13.500	3,18
HA17040	17x40	12	7	2,50	8	300	7.200	4,16
HA18040	18x40	15	12	3,00	8	300	7.200	5,10
HA18050	18x50	20	12	3,00	10	300	3.600	5,48
HA19050	19x50	15	12	3,50	8	200	4.800	6,84
HA19060	19x60	20	12	3,50	12	200	4.800	7,19
HA19070	19x70	25	12	3,50	15	200	2.400	8,84
HA20050	20x50	15	17	4,00	10	200	2.400	8,97
HA20060	20x60	20	17	4,00	10	200	2.400	9,57
HA20070	20x70	25	17	4,00	15	200	2.400	10,05
HA20080	20x80	30	17	4,00	18	200	2.400	11,03
HA21070	21x70	25	19	4,50	15	200	2.400	13,04
HA21080	21x80	30	19	4,50	18	200	2.400	14,25
HA21090	21x90	35	19	4,50	18	200	1.200	15,63
HA21100	21x100	40	19	4,50	24	100	1.200	16,72
HA22110	22x110	45	23	5,00	24	100	1.200	20,59
HA22120	22x120	50	23	5,00	30	50	600	24,36
HA23130	23x130	60	28	6,00	36	50	600	32,98

HC HEMBRILLA CERRADA



P. 204

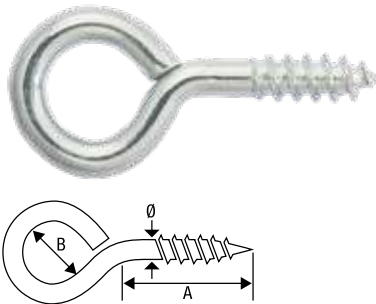

ZINCADO

CÓDIGO CODE	MEDIDA SIZE	A	B	Ø	ROSCA THREAD			€/ 100
HC14025	14x25	10	5	1,60	6	500	22.500	2,81
HC16030	16x30	12	5	1,90	8	300	13.500	3,18
HC17040	17x40	14	6	2,50	8	300	7.200	4,16
HC18040	18x40	16	7	3,00	10	300	7.200	5,10
HC18050	18x50	20	9	3,00	10	300	7.200	5,48
HC19050	19x50	20	9	3,50	12	200	4.800	6,84
HC19060	19x60	25	9	3,50	15	200	4.800	7,19
HC19070	19x70	30	9	3,50	15	200	4.800	8,84
HC20050	20x50	20	10	4,00	10	200	2.400	8,97
HC20060	20x60	20	10	4,00	15	200	2.400	9,57
HC20070	20x70	25	10	4,00	15	200	2.400	10,05
HC20080	20x80	30	10	4,00	15	200	2.400	11,03
HC21070	21x70	25	12	4,50	15	200	2.400	13,04
HC21080	21x80	30	12	4,50	18	200	2.400	14,25
HC21090	21x90	35	12	4,50	18	200	1.200	15,63
HC21100	21x100	40	12	4,50	24	100	1.200	16,72
HC22110	22x110	45	14	5,00	24	100	1.200	20,59
HC22120	22x120	50	14	5,00	30	50	600	24,36
HC23130	23x130	55	16	6,00	36	50	600	32,98

AR ALCAYATA ROSCADA



P. 204

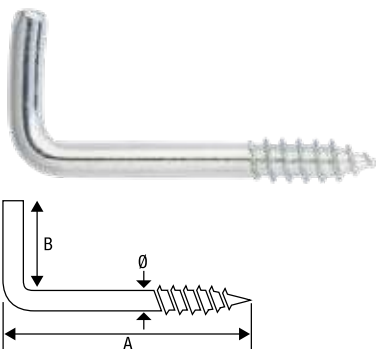

ZINCADO

CÓDIGO CODE	MEDIDA SIZE	A	B	Ø	ROSCA THREAD			€/ 100
AR14025	14x25	16	6	1,60	8	500	22.500	2,81
AR16030	16x30	18	6	2,00	8	300	13.500	3,18
AR17040	17x40	30	8,5	2,50	10	300	7.200	4,16
AR18040	18x40	30	10	3,00	10	300	7.200	5,10
AR18050	18x50	40	10	3,00	15	300	7.200	5,48
AR19050	19x50	40	12	3,50	15	200	4.800	6,84
AR19060	19x60	50	12	3,50	18	200	4.800	7,19
AR19070	19x70	60	12	3,50	18	200	2.400	8,84
AR20060	20x60	45	13	4,00	18	200	2.400	9,57
AR20070	20x70	50	13	4,00	18	200	2.400	10,05
AR20080	20x80	60	13	4,00	21	200	2.400	11,03
AR21080	21x80	60	14	4,50	21	200	2.400	14,25
AR21090	21x90	70	14	4,50	24	200	1.200	15,63
AR22100	22x100	80	17	5,00	30	100	1.200	16,72
AR22110	22x110	90	17	5,00	30	100	1.200	20,59
AR22120	22x120	100	17	5,00	30	50	600	24,36
AR23130	23x130	110	20	6,00	30	50	600	32,98

ALCAYATAS Y PUNTAS



madera
wood



SOLICITAR
FICHA TÉCNICA

PAZ

PUNTA DE ACERO, cabeza plana



ZINCADO

CÓDIGO CODE	MEDIDA SIZE			€ / 100
PAZ22520	2,25x20	500	22.500	1,14
PAZ22525	2,25x25	500	22.500	1,32
PAZ22530	2,25x30	500	12.000	1,53
PAZ25040	2,50x40	500	12.000	2,49
PAZ25050	2,50x50	500	6.000	2,62
PAZ29050	2,90x50	300	3.600	3,72
PAZ29060	2,90x60	300	3.600	4,36
PAZ29070	2,90x70	300	3.600	5,00
PAZ34030	3,40x30	500	4.000	2,98
PAZ34040	3,40x40	500	6.000	3,38
PAZ34050	3,40x50	100	4.500	4,88
PAZ34060	3,40x60	100	2.400	5,53
PAZ34070	3,40x70	100	2.400	6,29
PAZ34080	3,40x80	100	1.600	7,72

DOWEL

Espárragos DOWEL, doble rosca,
huella TORX y hexágono central



ZINCADO

CÓDIGO CODE	MEDIDA SIZE				€ / 100
DW06040	M-06x40	TX15	100	3.000	10,21
DW06050	M-06x50	TX15	100	2.400	12,18
DW06060	M-06x60	TX15	100	2.400	14,06
DW06070	M-06x70	TX15	100	1.600	16,44
DW06080	M-06x80	TX15	100	1.600	18,40
DW08050	M-08x50	TX25	100	1.600	13,12
DW08060	M-08x60	TX25	100	800	14,66
DW08070	M-08x70	TX25	100	800	17,71
DW08080	M-08x80	TX25	100	800	18,85
DW08090	M-08x90	TX25	100	800	22,64
DW08100	M-08x100	TX25	100	800	23,30
DW08110	M-08x110	TX25	100	800	26,35
DW08120	M-08x120	TX25	100	800	33,02
DW08130	M-08x130	TX25	100	800	38,58
DW10080	M-10x80	TX25	100	800	31,79
DW10100	M-10x100	TX25	100	400	38,17
DW10110	M-10x110	TX25	100	400	42,53
DW10120	M-10x120	TX25	100	400	51,55
DW10130	M-10x130	TX25	100	400	68,70
DW10140	M-10x140	TX25	100	400	72,41
DW10150	M-10x150	TX25	100	400	76,63
DW10180	M-10x180	TX25	100	300	105,66
DW10200	M-10x200	TX25	100	300	117,47



SOLICITAR
FICHA TÉCNICA

ACCESORIOS DE FIJACIÓN



DIN-3570 / ABA

ABARCÓN, con cuatro tuercas



ZINCADO

CÓDIGO CODE	MEDIDA SIZE	PULGADAS INCHES			€/ 100
ABA060250	M-6	1/4"	100	1.200	27,18
ABA060375	M-6	3/8"	100	1.200	27,55
ABA060500	M-6	1/2"	100	600	32,25
ABA060750	M-6	3/4"	100	600	37,41
ABA061000	M-6	1"	100	400	41,15
ABA061250	M-6	1 1/4"	50	300	53,75
ABA081500	M-8	1 1/2"	50	150	83,44
ABA082000	M-8	2"	50	150	95,10
ABA082250	M-8	2 1/4"	50	100	111,91
ABA082500	M-8	2 1/2"	50	100	116,71
ABA083000	M-8	3"	50	100	137,64
ABA083500	M-8	3 1/2"	50	100	149,08
ABA084000	M-8	4"	50	100	184,00
ABA084500	M-8	4 1/2"	25	100	194,60
ABA085000	M-8	5"	25	100	201,41
ABA086000	M-8	6"	25	100	228,99
ABA103000	M-10	3"	25	50	199,34
ABA103500	M-10	3 1/2"	25	50	207,53
ABA104000	M-10	4"	25	100	231,92
ABA105000	M-10	5"	-	25	266,16
ABA106000	M-10	6"	-	25	299,94
ABA108000	M-10	8"	-	25	377,71

AFO

ARGOLLA FORJADA



ZINCADO

CÓDIGO CODE	MEDIDA SIZE					€/ 100
AFOM06	M-6x55	10,00	55	100	1.200	70,04
AFOM08	M-8x60	11,80	60	100	600	101,22
AFOM10	M-10x73	14,50	73	50	300	150,85
AFOM12	M-12x90	17,00	90	50	200	290,92
AFOM16	M-16x95	23,50	95	25	100	642,90

GFO

GANCHO FORJADO



ZINCADO

CÓDIGO CODE	MEDIDA SIZE					€/ 100
GFOM06	M-6x55	8,00	55	100	1.200	70,04
GFOM08	M-8x60	10,00	60	100	600	101,22
GFOM10	M-10x73	12,50	73	50	300	150,85
GFOM12	M-12x90	16,00	90	50	100	290,92
GFOM16	M-16x95	19,00	95	25	50	642,90

AFOI - INOX A2

ARGOLLA FORJADA, **INOX A2**



INOX (A2)



INOXIDABLE A2

CÓDIGO CODE	MEDIDA SIZE					€/ 100
AFOIM06	M-6x55	10,00	55	100	1.200	208,50
AFOIM08	M-8x60	11,80	60	100	600	439,95
AFOIM10	M-10x73	14,50	73	50	300	816,95

GFOI - INOX A2

GANCHO FORJADO, **INOX A2**



INOX (A2)



INOXIDABLE A2

CÓDIGO CODE	MEDIDA SIZE					€/ 100
GFOIM06	M-6x55	8,00	55	100	1.200	199,70
GFOIM08	M-8x60	10,00	60	100	600	407,05
GFOIM10	M-10x73	12,50	73	50	300	765,35

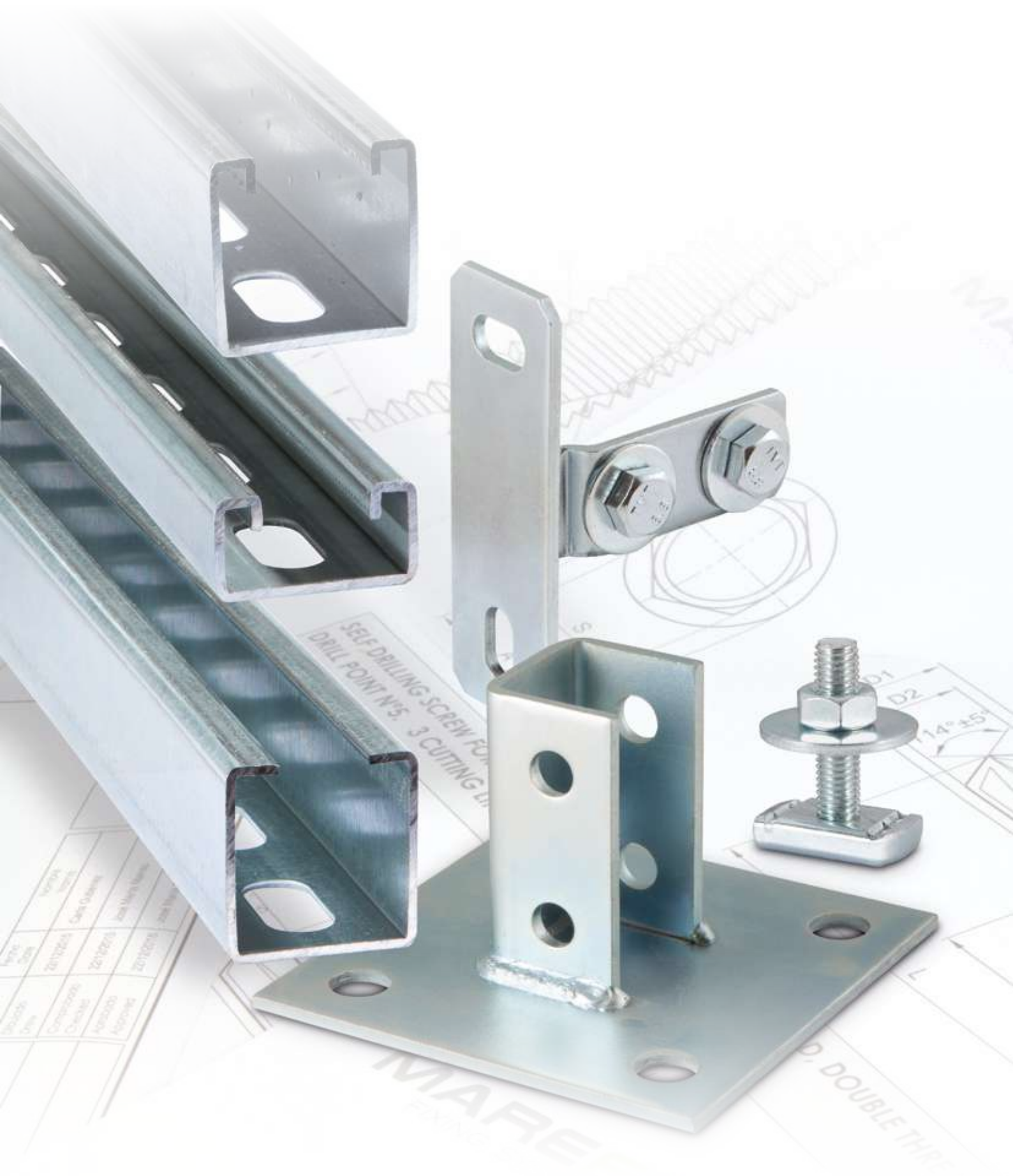



SOPORTACIÓN

PP-Z

GUÍA PERFORADA,
FORMA "C"



ZINCADO

CÓDIGO CODE	MEDIDA SIZE		€/ 100
PPZ201010	20x10x1 / 2000	30	701,59
PPZ250808	25x8x0,80 / 1000	30	578,99

PP-G

GUÍA PERFORADA,
FORMA "C"



PRE-GALVANIZADO

CÓDIGO CODE	MEDIDA SIZE		€/ 100
PPG271812	27x18x1,25 / 2000	12	1.267,98
PPG283018	28x30x1,80 / 2000	6	2.605,20
PPG384020	38x40x2,00 / 2000	6	4.303,35
PPG402015	40x20x1,50 / 2000	6	1.878,10

PSP-Z

SOPORTE PARA CARGAS LIGERAS,
FORMA "C"



ZINCADO

CÓDIGO CODE	MEDIDA SIZE		€/ 100
PSPZ271820	27x18x1,25 / 200	10	742,23
PSPZ271830	27x18x1,25 / 300	10	800,95
PSPZ384020	38x40x2 / 200	10	1.201,56
PSPZ384025	38x40x2 / 250	10	1.335,24
PSPZ384030	38x40x2 / 300	10	1.498,14
PSPZ384035	38x40x2 / 350	10	1.605,09
PSPZ384040	38x40x2 / 400	10	1.870,77
PSPZ384050	38x40x2 / 500	10	2.271,93
PSPZ384060	38x40x2 / 600	10	2.529,99

PSP-V

SOPORTE VERTICAL



ZINCADO

CÓDIGO CODE	MEDIDA SIZE		€/ 100
PSPV2718	M-10 (27/18 - 28/30)	50	523,68
PSPV3840	M-10 (38/40 - 40/20)	50	565,25

PSP-H

SOPORTE HORIZONTAL



ZINCADO

CÓDIGO CODE	MEDIDA SIZE		€/ 100
PSPH2718	M-10 (27/18 - 28/30)	50	474,89
PSPH3840	M-10 (38/40 - 40/20)	50	492,54

SOPORTACIÓN



PSP-HX

SOPORTE HORIZONTAL
GUÍAS



ZINCADO

CÓDIGO CODE	MEDIDA SIZE		€/ 100
PSPHX2718	M-10 (27/18 - 28/30)	10	730,69
PSPHX3840	M-10 (38/40-40/20-41/21-41/41)	10	1.420,13

PTGZ

TOPE, TORNILLO GUÍA
PERFORADA



ZINCADO

CÓDIGO CODE	MEDIDA SIZE			€/ 100
PTGZ230620	M-06x20	100	800	67,72
PTGZ230820	M-08x20	100	400	81,72
PTGZ230830	M-08x30	100	600	86,01
PTGZ340830	M-08x30	100	600	115,51
PTGZ341030	M-10x30	100	400	148,80

PEZ

ESCUADRAS



ZINCADO

CÓDIGO CODE	MEDIDA SIZE			€/ 100
PEZ045	50x50x45°	100	400	125,88
PEZ090	54x54x90°	100	300	125,88
PEZ180	100x180°	100	100	122,73

PSP-S

SOPORTE REFORZADO



ZINCADO

NEW

CÓDIGO CODE	MEDIDA SIZE		€/ 100
PSPS322037	32x20x370	5	2.493,33
PSPS322054	32x20x545	5	3.292,33

PP-X 21

GUÍA PERFORADA,
STRUT



PRE-GALVANIZADO

CÓDIGO CODE	MEDIDA SIZE		€/ 100
PPX412115	41x21x1,50 / 3000	4	3.959,83
PPX412120	41x21x2,00 / 3000	4	4.451,36
PPX412125	41x21x2,50 / 3000	4	6.102,19
PPX4121202M	41x21x2,00 / 2000	6	2.967,57

PP-X 41

GUÍA PERFORADA,
STRUT



PRE-GALVANIZADO

CÓDIGO CODE	MEDIDA SIZE		€/ 100
PPX414115	41x41x1,50 / 3000	4	4.806,68
PPX414120	41x41x2,00 / 3000	4	6.857,65
PPX414125	41x41x2,50 / 3000	2	8.400,92
PPX4141202M	41x41x2,00 / 2000	6	4.571,77



SOLICITAR
FICHA TÉCNICA

SOPORTACIÓN

PSP-X

SOPORTE STRUT,
PARA CARGAS PESADAS



ZINCADO

CÓDIGO CODE	MEDIDA SIZE		€/ 100
PSPX412115	41x21x2,50 / 150	10	1.063,13
PSPX412130	41x21x2,50 / 300	10	1.478,36
PSPX412145	41x21x2,50 / 450	10	1.839,90
PSPX414115	41x41x2,50 / 150	10	1.363,70
PSPX414130	41x41x2,50 / 300	10	1.900,68
PSPX414145	41x41x2,50 / 450	10	2.485,48
PSPX414160	41x41x2,50 / 600	10	3.124,97
PSPX414175	41x41x2,50 / 750	10	3.864,89
PSPX414110	41x41x2,50 / 1000	2	4.860,40

PSP-RX

SOPORTE STRUT,
BASE RECTANGULAR,
FORMA "U"



ZINCADO

CÓDIGO CODE	MEDIDA SIZE		€/ 100
PSPRXH4121	HORIZONTAL	12	1.340,15
PSPRXV4121	VERTICAL	12	1.340,15

PSP-UX

SOPORTE STRUT,
BASE CUADRADA,
FORMA "U"



ZINCADO

CÓDIGO CODE	MEDIDA SIZE		€/ 100
PSPUX412100	0°	12	1.702,93
PSPUX412145	45°	12	1.702,93

PTGXZ

TOPE, TORNILLO GUÍA
PERFORADA STRUT



ZINCADO

CÓDIGO CODE	MEDIDA SIZE			€/ 100
PTGXZ0840	M-08x40	100	400	121,74
PTGXZ0860	M-08x60	50	300	133,14
PTGXZ1040	M-10x40	50	300	161,87
PTGXZ1060	M-10x60	50	200	181,55

PPR-X

SOPORTE REGULABLE
STRUT



ZINCADO

NEW	CÓDIGO CODE	MEDIDA SIZE			€/ 100
	PPRX01	M8 (41-21 - 41/41)	12		1.479,57

PEI-X

ESCUADRA PARA
STRUT



ZINCADO

NEW	CÓDIGO CODE	MEDIDA SIZE	Nº AGUJEROS No. OF HOLES			€/ 100
	PEIX9004	98 x 98 x 5 / 90°	4	25	75	297,41

SOPORTACIÓN



PERI

ESCUADRA REFORZADA STRUT



NEW

ZINCADO						
CÓDIGO CODE	MEDIDA SIZE	Nº AGUJEROS No. OF HOLES			€/ 100	
PERI090	100 x 100 x 40	-	-	10	734,81	

PSP-M

ESCUADRA REFORZADA PARA PERFILES "C" y STRUT



NEW

ZINCADO						
CÓDIGO CODE	PARA PERFIL FOR PROFILE			€/ 100		
PSPM3220	PP-G 30x15 - 32x20	-	10	9.000,00		
PSPM3840	PP-G 38x40	-	10	9.372,00		
PSPM4141	PP-X 41x21 - 41x41	-	10	10.122,00		

PUNI

PLACA DE UNIÓN STRUT



NEW

ZINCADO						
CÓDIGO CODE	MEDIDA SIZE	Nº AGUJEROS No. OF HOLES			€/ 100	
PUNI141211	40 x 40 x 5	1	50	300	78,03	
PUNI141212	40 x 90 x 5	2	25	150	161,10	
PUNI141213	40 x 138 x 5	3	25	125	226,54	
PUNI141214	40 x 186 x 5	4	10	60	281,92	

PUNEX

PLACA DE UNIÓN ESCUADRA STRUT



NEW

ZINCADO						
CÓDIGO CODE	MEDIDA SIZE	Nº AGUJEROS No. OF HOLES			€/ 100	
PUNEX41213	89 x 89 x 5	3	-	25	410,27	

PEC

PLACA DE CONEXIÓN



NEW

ZINCADO						
CÓDIGO CODE	PARA PERFIL FOR PROFILE			€/ 100		
PEC3220	PP-G 30x15 - 32x20	100	400	546,00		

PEX

ESCUADRAS PARA PERFILES STRUT

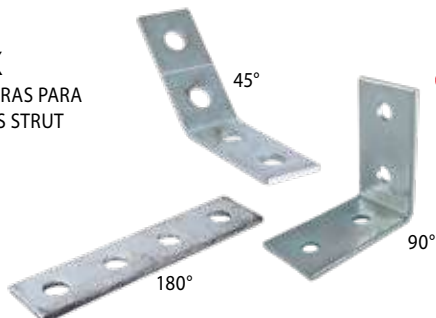

NEW

ZINCADO						
CÓDIGO CODE	MEDIDA SIZE	PARA PERFIL FOR PROFILE			€/ 100	
PEX045	87x87x40x6 45°	PP-X 41x21 - 41x41	-	25	474,00	
PEX090	86x102x6 90°	PP-X 41x21 - 41x41	25	75	516,00	
PEX180	168x40x6 180°	PP-X 41x21 - 41x41	10	60	426,00	

SOPORTACIÓN



SOLICITAR
FICHA TÉCNICA

PEX-L

PLACA DE UNIÓN,
ESCUADRA STRUT



NEW	ZINCADO		PARA PERFIL FOR PROFILE			€ / 100
	CÓDIGO CODE	MEDIDA SIZE				
	PEXL41	85x85x40x6	PP-X 41x21 - 41x41	-	25	366,00

PEX-T

PLACA DE UNIÓN "T"
STRUT



NEW	ZINCADO		PARA PERFIL FOR PROFILE			€ / 100
	CÓDIGO CODE	MEDIDA SIZE				
	PEXT41	138x90x6	PP-X 41x21 - 41x41	-	25	510,00

PMX-C

PLETINA DE FIJACIÓN



NEW	ZINCADO				€ / 100
	CÓDIGO CODE	MEDIDA SIZE			
	PMXC8-10	80x30x3 - M8/M10	-	25	822,00
	PMXC1/2	120x40x4 - 1/2"	-	25	1.482,00

PTP

TAPONES PLÁSTICOS,
PARA GUÍAS FORMA "C"



CÓDIGO CODE	MEDIDA SIZE			€ / 100
PTP2718	27 / 18	100	400	31,16
PTP2830	28 / 30	100	300	37,47
PTP3840	38 / 40	100	300	60,75
PTP4121	41 / 21	100	600	49,92
PTP4141	41 / 41	100	300	52,34



ABRAZADERAS



tubo de acero
steel tube



tubo de cobre
copper tube



tubo de PVC
PVC tube



tubo flexible
flexible tube



SOLICITAR
FICHA TÉCNICA

AS

Abrazadera SIN-FIN



ZINCADO

CÓDIGO CODE	MEDIDA SIZE	PULGADAS INCHES	Ø MAX			€/ 100
AS008016	8 - 16	5/16" - 5/8"	8 - 16	100	1.200	30,29
AS012022	12 - 22	1/2" - 7/8"	12 - 22	100	600	31,11
AS016027	16 - 27	5/8" - 1 1/16"	16 - 27	100	600	33,08
AS020032	20 - 32	3/4" - 1 1/4"	20 - 32	100	600	36,90
AS025040	25 - 40	1" - 1 5/8"	25 - 40	100	400	41,77
AS030045	30 - 45	1 3/16" - 1 3/4"	30 - 45	100	300	46,60
AS035050	35 - 50	1 3/8" - 2"	35 - 50	100	300	49,34
AS040060	40 - 60	1 5/8" - 2 3/8"	40 - 60	100	200	54,28
AS050070	50 - 70	2" - 2 3/4"	50 - 70	50	100	64,60
AS060080	60 - 80	2 3/8" - 3 1/8"	60 - 80	50	100	66,41
AS070090	70 - 90	2 3/4" - 3 1/2"	70 - 90	50	100	69,56
AS080100	80 - 100	3 1/8" - 4"	80 - 100	50	100	72,75
AS090110	90 - 110	3 1/2" - 4 3/8"	90 - 110	50	100	81,55
AS100120	100 - 120	4" - 4 3/4"	100 - 120	25	50	91,42
AS110130	110 - 130	4 3/8" - 5 1/8"	110 - 130	25	50	95,95
AS120140	120 - 140	4 3/4" - 5 1/2"	120 - 140	25	50	101,15
AS130150	130 - 150	5 1/8" - 5 7/8"	130 - 150	25	50	107,87



tubo de acero
steel tube



tubo de cobre
copper tube



tubo de PVC
PVC tube



tubo flexible
flexible tube



SOLICITAR
FICHA TÉCNICA

AP

Abrazadera GRAN PRESIÓN



ZINCADO

CÓDIGO CODE	MEDIDA SIZE	PERFIL FLEJE	Ø MAX			€/ 100
AP023025	23 - 25	18x0,60	23 - 25	50	300	145,40
AP026028	26 - 28	18x0,60	26 - 28	50	300	151,19
AP029031	29 - 31	20x0,80	29 - 31	50	200	176,20
AP032035	32 - 35	20x0,80	32 - 35	50	150	186,65
AP036039	36 - 39	20x0,80	36 - 39	50	150	189,86
AP040043	40 - 43	20x0,80	40 - 43	50	100	201,14
AP044047	44 - 47	22x1,20	44 - 47	50	100	232,43
AP048051	48 - 51	22x1,20	48 - 51	25	75	242,62
AP052055	52 - 55	22x1,20	52 - 55	25	75	247,98
AP056059	56 - 59	22x1,20	56 - 59	25	75	253,87
AP060063	60 - 63	22x1,20	60 - 63	25	50	264,59
AP064067	64 - 67	22x1,50	64 - 67	25	50	332,34
AP068073	68 - 73	24x1,50	68 - 73	-	25	361,14
AP074079	74 - 79	24x1,50	74 - 79	-	25	393,74
AP080085	80 - 85	24x1,50	80 - 85	-	25	405,95
AP086091	86 - 91	24x1,50	86 - 91	-	25	413,66
AP092097	92 - 97	24x1,50	92 - 97	-	25	433,72
AP098103	98 - 103	24x1,50	98 - 103	-	25	438,22
AP104112	104 - 112	24x1,50	104 - 112	-	25	456,87
AP113121	113 - 121	24x1,50	113 - 121	-	25	472,68
AP122130	122 - 130	24x1,50	122 - 130	-	25	496,43
AP131139	131 - 139	24x1,50	131 - 139	-	25	660,26
AP140148	140 - 148	24x1,50	140 - 148	-	25	667,61
AP149161	149 - 161	25x1,70	149 - 161	-	25	714,69
AP162174	162 - 174	25x1,70	162 - 174	-	25	769,14

ABRAZADERAS



tubo de acero
steel tube

tubo de cobre
copper tube

tubo de PVC
PVC tube



SOLICITAR
FICHA TÉCNICA

ARI

Abrazadera REFORZADA ISOFÓNICA, M8 + M10



ZINCADO

CÓDIGO CODE	MEDIDA SIZE	Ø MAX	CARGA MÁXIMA			€/ 100
ARI0018	18	15 - 19	80	50	200	121,62
ARI0022	22	20 - 25	80	50	150	132,09
ARI0028	28	26 - 30	80	50	150	140,85
ARI0035	35	32 - 36	80	50	100	150,64
ARI0040	40	38 - 43	80	25	75	171,00
ARI0048	48	47 - 51	80	25	75	182,59
ARI0054	54	53 - 56	80	25	50	198,61
ARI0060	60	60 - 64	80	25	50	210,77
ARI0070	70	68 - 72	80	-	25	229,67
ARI0075	75	75 - 80	150	-	25	238,07
ARI0083	83	81 - 86	150	-	25	261,31
ARI0090	90	87 - 92	150	-	25	260,17
ARI0100	100	99 - 105	150	-	25	301,50
ARI0110	110	107 - 112	150	-	25	316,94
ARI0115	115	113 - 118	200	-	25	353,54
ARI0125	125	125 - 130	200	-	25	364,30
ARI0140	140	138 - 142	200	-	25	428,08
ARI0150	150	148 - 152	200	-	25	437,54
ARI0160	160	159 - 166	200	-	25	472,87
ARI0200	200	199 - 212	200	-	25	603,41
ARI0250	250	245 - 254	200	-	25	728,88
ARI0300	300	299 - 304	200	-	25	886,32
ARI0315	315	314 - 319	200	-	25	986,79



tubo de PVC
PVC tube

tubo acero inoxidable
stainless steel pipe



SOLICITAR
FICHA TÉCNICA

ARI-A2

Abrazadera REFORZADA ISOFÓNICA, M8 + M10
INOXIDABLE A2



INOX A2

NEW CÓDIGO CODE	MEDIDA SIZE	Ø MAX	CARGA MÁXIMA			€/ 100
ARIA20018	18	15 - 18	150	50	200	442,62
ARIA20022	22	20 - 24	150	50	150	454,83
ARIA20028	28	26 - 30	150	50	150	475,07
ARIA20035	35	32 - 36	150	50	100	499,82
ARIA20040	40	38 - 42	150	25	75	549,31
ARIA20048	48	47 - 50	150	25	75	582,18
ARIA20054	54	51 - 55	150	25	50	627,30
ARIA20060	60	60 - 64	150	25	50	661,35
ARIA20075	75	75 - 80	150	-	25	745,06
ARIA20090	90	87 - 92	150	-	25	783,18
ARIA20110	110	106 - 112	150	-	25	884,71
ARIA20115	115	114 - 119	150	-	25	876,58
ARIA20125	125	124 - 131	150	-	25	971,76
ARIA20140	140	133 - 140	150	-	25	1.035,97
ARIA20160	160	159 - 163	150	-	25	1.126,96
ARIA20200	200	199 - 212	150	-	25	1.336,18
ARIA20250	250	245 - 254	150	-	25	1.583,79

ARI-A4

Abrazadera REFORZADA ISOFÓNICA, M8 + M10
INOXIDABLE A4



INOX A4

NEW CÓDIGO CODE	MEDIDA SIZE	Ø MAX	CARGA MÁXIMA			€/ 100
ARIA40018	18	15 - 18	150	50	200	561,08
ARIA40022	22	20 - 24	150	50	150	589,86
ARIA40028	28	26 - 30	150	50	150	612,69
ARIA40035	35	32 - 36	150	50	100	661,81
ARIA40040	40	38 - 42	150	25	75	706,34
ARIA40048	48	47 - 50	150	25	75	766,92
ARIA40054	54	51 - 55	150	25	50	812,75
ARIA40060	60	60 - 64	150	25	50	879,77
ARIA40075	75	75 - 80	150	-	25	953,13
ARIA40090	90	87 - 92	150	-	25	1.050,97
ARIA40110	110	106 - 112	150	-	25	1.239,14
ARIA40115	115	114 - 119	150	-	25	1.294,58
ARIA40125	125	124 - 131	150	-	25	1.364,73
ARIA40140	140	133 - 140	150	-	25	1.398,77
ARIA40160	160	159 - 163	150	-	25	1.660,82
ARIA40200	200	199 - 212	150	-	25	1.895,56
ARIA40250	250	245 - 254	150	-	25	2.256,37

ABRAZADERAS



tubo de acero
steel tube

tubo de cobre
copper tube

tubo de PVC
PVC tube



SOLICITAR
FICHA TÉCNICA

ARE

Abrazadera REFORZADA M8 + M10



ZINCADO

CÓDIGO CODE	MEDIDA SIZE	Ø MAX	CARGA MÁXIMA			€/ 100
ARE0018	18	15 - 19	80	50	300	106,15
ARE0022	22	20 - 25	80	50	200	110,38
ARE0028	28	26 - 30	80	50	150	120,15
ARE0035	35	32 - 36	80	50	100	126,48
ARE0040	40	38 - 43	80	25	100	136,68
ARE0048	48	47 - 51	80	25	100	150,66
ARE0054	54	53 - 56	80	25	75	160,72
ARE0060	60	60 - 64	80	25	75	164,94
ARE0070	70	68 - 72	80	25	50	177,75
ARE0075	75	75 - 80	150	25	50	182,40
ARE0083	83	81 - 86	150	-	25	186,47
ARE0090	90	87 - 92	150	-	25	192,94
ARE0100	100	99 - 105	150	-	25	212,82
ARE0110	110	107 - 112	150	-	25	228,65
ARE0115	115	113 - 118	200	-	25	255,07
ARE0125	125	125 - 130	200	-	25	264,51
ARE0140	140	138 - 142	200	-	25	327,92
ARE0150	150	148 - 152	200	-	25	329,95
ARE0160	160	159 - 166	200	-	25	349,79
ARE0200	200	199 - 212	200	-	25	440,26
ARE0250	250	245 - 254	200	-	25	556,10
ARE0300	300	299 - 304	200	-	25	714,54
ARE0315	315	314 - 319	200	-	25	803,58



tubo de PVC
PVC tube

tubo acero inoxidable
stainless steel pipe



SOLICITAR
FICHA TÉCNICA

ARE-A2

Abrazadera REFORZADA M8 + M10
INOXIDABLE A2



INOX (A2)



INOX A2

NEW CÓDIGO CODE	MEDIDA SIZE	Ø MAX	CARGA MÁXIMA			€/ 100
AREA20018	18	15 - 18	150	50	300	373,51
AREA20022	22	20 - 24	150	50	200	385,10
AREA20028	28	26 - 30	150	50	150	434,30
AREA20035	35	32 - 36	150	50	100	452,22
AREA20040	40	38 - 42	150	25	100	477,63
AREA20048	48	47 - 50	150	25	100	503,76
AREA20054	54	51 - 55	150	25	75	532,02
AREA20060	60	60 - 64	150	25	75	548,85
AREA20075	75	75 - 80	150	25	50	610,59
AREA20090	90	87 - 92	150	-	25	653,36
AREA20110	110	106 - 112	150	-	25	722,04
AREA20115	115	114 - 119	150	-	25	769,02
AREA20125	125	124 - 131	150	-	25	807,84
AREA20140	140	133 - 140	150	-	25	968,97
AREA20160	160	159 - 163	150	-	25	1.062,07
AREA20200	200	199 - 212	150	-	25	1.420,99
AREA20250	250	245 - 254	150	-	25	1.506,94

ARE-A4

Abrazadera REFORZADA M8 + M10
INOXIDABLE A4



INOX (A4)



INOX A4

NEW CÓDIGO CODE	MEDIDA SIZE	Ø MAX	CARGA MÁXIMA			€/ 100
AREA40018	18	15 - 18	150	50	300	452,15
AREA40022	22	20 - 24	150	50	200	464,40
AREA40028	28	26 - 30	150	50	150	495,97
AREA40035	35	32 - 36	150	50	100	548,60
AREA40040	40	38 - 42	150	25	100	572,13
AREA40048	48	47 - 50	150	25	100	635,77
AREA40054	54	51 - 55	150	25	75	663,29
AREA40060	60	60 - 64	150	25	75	687,41
AREA40075	75	75 - 80	150	25	50	784,48
AREA40090	90	87 - 92	150	-	25	812,43
AREA40110	110	106 - 112	150	-	25	953,79
AREA40115	115	114 - 119	150	-	25	1.023,26
AREA40125	125	124 - 131	150	-	25	1.066,91
AREA40140	140	133 - 140	150	-	25	1.311,62
AREA40160	160	159 - 163	150	-	25	1.399,76
AREA40200	200	199 - 212	150	-	25	1.679,88
AREA40250	250	245 - 254	150	-	25	1.890,80

ABRAZADERAS



tubo de acero
steel tube

tubo de cobre
copper tube

tubo de PVC
PVC tube



SOLICITAR
FICHA TÉCNICA

AM8

Abrazadera DESAGÜE M8



ZINCADO

CÓDIGO CODE	MEDIDA SIZE	Ø MAX	CARGA MÁXIMA		€ / 100
AM8050	50	49 - 54	100	100	143,33
AM8063	63	60 - 65	100	100	139,30
AM8075	75	75 - 80	100	100	143,93
AM8090	90	88 - 92	100	100	153,92
AM8110	110	108 - 113	100	100	168,41
AM8125	125	124 - 130	100	100	180,41
AM8160	160	159 - 165	100	100	245,99
AM8200	200	199 - 203	100	100	286,21
AM8250	250	249 - 254	100	50	380,72
AM8315	315	314 - 319	100	50	829,56



tubo de acero
steel tube

tubo de cobre
copper tube

tubo de PVC
PVC tube

tubo flexible
flexible tube



SOLICITAR
FICHA TÉCNICA

GPI

Grapa 1 PIE



ZINCADO

CÓDIGO CODE	MEDIDA SIZE	Ø MAX	CARGA MÁXIMA			€ / 100
GPI006	6	6	30	100	4.500	7,81
GPI008	8	8	30	100	2.400	8,56
GPI010	10	10	30	100	2.400	9,22
GPI012	12	12	30	100	2.400	9,77
GPI014	14	14	30	100	2.400	10,49
GPI016	16	16	30	100	1.200	11,19
GPI018	18	18	30	100	1.200	16,97
GPI020	20	20	30	100	1.200	17,77
GPI022	22	22	30	100	600	19,52
GPI025	25	25	30	100	600	21,39
GPI026	26	26	30	100	600	21,82
GPI028	28	28	30	100	600	22,38
GPI032	32	32	30	100	600	26,44
GPI040	40	40	30	50	300	33,39
GPI042	42	42	30	50	300	35,70
GPI047	47	47	30	50	200	39,86
GPI050	50	50	30	50	200	46,00



tubo de acero
steel tube

tubo de cobre
copper tube

tubo de PVC
PVC tube

tubo flexible
flexible tube



SOLICITAR
FICHA TÉCNICA

GPU

Grapa PUENTE



ZINCADO

CÓDIGO CODE	MEDIDA SIZE	Ø MAX	CARGA MÁXIMA			€ / 100
GPU016	16	16	75	100	1.200	19,52
GPU018	18	18	75	100	1.200	26,38
GPU020	20	20	75	100	600	28,23
GPU022	22	22	75	100	600	29,69
GPU025	25	25	75	100	600	30,95
GPU028	28	28	75	100	600	32,26
GPU032	32	32	75	50	300	39,84
GPU037	37	37	75	50	300	38,49
GPU040	40	40	75	50	300	39,88
GPU050	50	50	75	50	200	55,99
GPU063	63	63	75	50	150	99,43

ABRAZADERAS



tubo de acero
steel tube

tubo de cobre
copper tube

tubo de PVC
PVC tube



SOLICITAR
FICHA TÉCNICA

A6

Abrazadera M6



BICROMATADO

CÓDIGO CODE	MEDIDA SIZE	Ø MAX	CARGA MÁXIMA			€/ 100
A6008	8	8	70	100	1.200	19,34
A6010	10	10	70	100	1.200	19,33
A6012	12	12	70	100	1.200	19,49
A6014	14	14	70	100	1.200	20,27
A6015	15	15	70	100	600	20,28
A6016	16	16	70	100	600	21,06
A6018	18	18	70	100	600	21,14
A6020	20	20	70	100	600	21,67
A6022	22	22	70	100	600	22,43
A6025	25	25	70	100	600	23,56
A6026	26	26	70	100	400	24,14
A6028	28	28	70	100	400	24,86
A6032	32	32	70	50	300	27,52
A6035	35	35	70	50	300	31,10
A6037	37	37	100	50	300	32,81
A6040	40	40	100	50	300	34,72
A6042	42	42	100	50	300	36,01
A6047	47	47	100	50	200	39,15
A6050	50	50	100	50	150	39,73
A6054	54	54	100	50	150	45,23
A6060	60	60	100	50	150	51,61
A6063	63	63	100	50	100	52,83

A6

Abrazadera M6



ZINCADO

NEW

CÓDIGO CODE	MEDIDA SIZE	Ø MAX	CARGA MÁXIMA			€/ 100
A6Z08	8	8	70	100	1.200	19,34
A6Z10	10	10	70	100	1.200	19,33
A6Z12	12	12	70	100	1.200	19,49
A6Z14	14	14	70	100	1.200	20,27
A6Z15	15	15	70	100	600	20,28
A6Z16	16	16	70	100	600	21,06
A6Z18	18	18	70	100	600	21,14
A6Z20	20	20	70	100	600	21,67
A6Z22	22	22	70	100	600	22,43
A6Z25	25	25	70	100	600	23,56
A6Z26	26	26	70	100	400	24,14
A6Z28	28	28	70	100	400	24,86
A6Z32	32	32	70	50	300	27,52
A6Z35	35	35	70	50	300	31,10
A6Z37	37	37	100	50	300	32,81
A6Z40	40	40	100	50	300	34,72
A6Z42	42	42	100	50	300	36,01
A6Z47	47	47	100	50	200	39,15
A6Z50	50	50	100	50	150	39,73
A6Z54	54	54	100	50	150	45,23
A6Z60	60	60	100	50	150	51,61
A6Z63	63	63	100	50	100	52,83

A6I

Abrazadera ISOFÓNICA M6



BICROMATADO

CÓDIGO CODE	MEDIDA SIZE	Ø MAX	CARGA MÁXIMA			€/ 100
A6I012	12	12	70	100	600	29,35
A6I015	15	15	70	100	600	30,76
A6I016	16	16	70	100	600	32,13
A6I018	18	18	70	100	600	33,35
A6I022	22	22	70	100	400	36,88
A6I026	26	26	70	100	400	41,19
A6I028	28	28	70	100	300	42,85
A6I032	32	32	70	50	200	47,74
A6I035	35	35	70	50	200	53,34
A6I042	42	42	100	50	150	65,33
A6I048	48	48	100	50	100	72,56
A6I054	54	54	100	50	100	80,75
A6I060	60	60	100	50	100	87,53

ABRAZADERAS

AD6

Abrazadera DOBLE M6



AD6I

Abrazadera DOBLE ISOFÓNICA M6



TRONCONE rosca doble

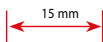

ATZ

Tirafondo abrazadera, DOBLE ROSCA



ATB

Tirafondo abrazadera, DOBLE ROSCA



ATGZ

Tirafondo GRAPA, huella COMBI



DOWEL

Espárragos DOWEL, doble rosca, huella TORX y hexágono central



BICROMATADO

CÓDIGO CODE	MEDIDA SIZE	Ø MAX	CARGA MÁXIMA			€/ 100
AD6012	12	12	100	50	600	30,20
AD6015	15	15	100	50	300	33,57
AD6018	18	18	100	50	300	36,51
AD6022	22	22	100	50	300	41,82
AD6028	28	28	100	50	200	47,55

BICROMATADO

CÓDIGO CODE	MEDIDA SIZE	Ø MAX	CARGA MÁXIMA			€/ 100
AD6I012	12	12	100	50	300	54,71
AD6I015	15	15	100	50	300	60,90
AD6I018	18	18	100	50	200	67,79
AD6I022	22	22	100	50	200	80,45
AD6I028	28	28	100	50	150	107,03

NEW

CÓDIGO CODE	MEDIDA SIZE	MAX.			€/ 100
38153	M6x65/50	50	50	500	106,75
38152	M8x65/50	50	50	500	125,00

ZINCADO

CÓDIGO CODE	MEDIDA SIZE			€/ 100
ATZ0840	M-08x40	100	2.400	8,87
ATZ0860	M-08x60	100	1.200	11,71
ATZ0880	M-08x80	100	1.200	17,66
ATZ1050	M-10x50	100	1.200	19,70
ATZ1070	M-10x70	100	600	25,17

BICROMATADO

CÓDIGO CODE	MEDIDA SIZE			€/ 100
ATB0630	M-06x30	100	4.500	5,06
ATB0640	M-06x40	100	2.400	6,20
ATB0650	M-06x50	100	2.400	7,15

ZINCADO

CÓDIGO CODE	MEDIDA SIZE			€/ 100
ATGZ4530	4,5x30	100	4.500	7,11
ATGZ4535	4,5x35	100	4.500	7,80
ATGZ4540	4,5x40	100	2.400	8,12
ATGZ5030	5,0x30	100	2.400	9,20
ATGZ5040	5,0x40	100	2.400	9,74

ZINCADO

CÓDIGO CODE	MEDIDA SIZE			€/ 100
DW06040	M-06x40 TX15	100	3.000	10,21
DW06050	M-06x50 TX15	100	2.400	12,18
DW06060	M-06x60 TX15	100	2.400	14,06
DW06070	M-06x70 TX15	100	1.600	16,44
DW06080	M-06x80 TX15	100	1.600	18,40
DW08050	M-08x50 TX25	100	1.600	13,12
DW08060	M-08x60 TX25	100	800	14,66
DW08070	M-08x70 TX25	100	800	17,71
DW08080	M-08x80 TX25	100	800	18,85
DW08090	M-08x90 TX25	100	800	22,64
DW08100	M-08x100 TX25	100	800	23,30
DW08110	M-08x110 TX25	100	800	26,35

ZINCADO

CÓDIGO CODE	MEDIDA SIZE			€/ 100
DW08120	M-08x120 TX25	100	800	33,02
DW08130	M-08x130 TX25	100	800	38,58
DW10080	M-10x80 TX25	100	800	31,79
DW10100	M-10x100 TX25	100	400	38,17
DW10110	M-10x110 TX25	100	400	42,53
DW10120	M-10x120 TX25	100	400	51,55
DW10130	M-10x130 TX25	100	400	68,70
DW10140	M-10x140 TX25	100	400	72,41
DW10150	M-10x150 TX25	100	400	76,63
DW10180	M-10x180 TX25	100	300	105,66
DW10200	M-10x200 TX25	100	300	117,47

ABRAZADERAS

SOPORTE RADIADOR SRT-RG

Regulable, triangular



CÓDIGO CODE	MEDIDA SIZE	Nº PIEZAS KIT		€ / KIT
VSRTRG095	95	2	50	4,50



tubo de acero
steel tube

tubo de cobre
copper tube

tubo de PVC
PVC tube

AB-CLS

Abrazadera/clip simple
con casquillo de latón M6



NEW CÓDIGO CODE	MEDIDA SIZE	Ø TUBO Ø TUBE			€ / 100
ABCLS12	12	12	100	1.200	30,15
ABCLS14	14-15	14-15	100	600	35,81
ABCLS16	16-18	16-18	100	600	40,91
ABCLS20	20-22	20-22	100	400	43,86
ABCLS25	25	25	50	300	45,22
ABCLS28	28	28	25	100	58,93

AB-CLD

Abrazadera/clip doble
con casquillo de latón M6



NEW CÓDIGO CODE	MEDIDA SIZE	Ø TUBO Ø TUBE			€ / 100
ABCLD12	12	12	50	200	53,96
ABCLD14	14-15	14-15	50	300	57,75
ABCLD16	16-18	16-18	50	200	69,83
ABCLD20	20-22	20-22	50	150	82,02
ABCLD28	28	28	25	100	111,30

AB-CIE

Abrazadera guía simple
con pre-rosca M6, gris



DISPONIBLE EN NEGRO,
BAJO PEDIDO

NEW CÓDIGO CODE	MEDIDA SIZE	Ø TUBO Ø TUBE			€ / 100
ABCIE12	12	12	100	400	26,92
ABCIE15	15	15	100	400	29,52
ABCIE16	16	16	100	400	30,15
ABCIE18	18	18	100	300	33,77
ABCIE20	20	20	100	300	35,87
ABCIE22	22	22	100	200	36,89
ABCIE25	25	25	50	150	40,29
ABCIE28	28	28	50	150	50,04
ABCIE32	32	32	25	100	52,59
ABCIE35	35	35	25	100	61,99
ABCIE37	37	37	25	100	65,34
ABCIE40	40	40	25	100	68,51
ABCIE42	42	42	25	100	70,89
ABCIE47	47	47	25	100	72,87
ABCIE50	50	50	25	100	93,22

FC

Clip rápido nylon



CÓDIGO CODE	MEDIDA SIZE	DESCR.	Ø TUBO Ø TUBE			€ / 100
HFC01	.	FC16	16	100	800	15,34
HFC02	.	FC20	20	100	800	16,43
HFC03	.	FC25	25	100	600	19,44
HFC04	.	FC32	32	50	400	27,40
HFC05	.	FC40	40	50	300	48,10
HFC06	.	FC50	50	25	200	61,26

ABRAZADERAS



tubo de acero
steel tube

tubo de cobre
copper tube

tubo de PVC
PVC tube

AB-MULTI

Abrazadera multidímetro



BLANCA

GRIS

NYLON POLIAMIDA 6.6

NEW

CÓDIGO CODE	MEDIDA SIZE	COLOR	Ø TUBO Ø TUBE			€/ 100
ABMUL15B	15-18	Blanca	15-18	100	400	30,94
ABMUL20B	20-25	Blanca	20-25	100	300	46,92
ABMUL25B	25-32	Blanca	25-32	50	150	52,36
ABMUL15G	15-18	Gris	15-18	100	400	30,94
ABMUL20G	20-25	Gris	20-25	100	300	46,92
ABMUL25G	25-32	Gris	25-32	50	150	52,36



tubo de acero
steel tube

tubo de cobre
copper tube

tubo de PVC
PVC tube

FQ

Abrazadera nylon, cuadrada, rápida



POLIAMIDA 6.6

CÓDIGO CODE	MEDIDA SIZE	DESCR.	Ø TUBO Ø TUBE			€/ 100
HFQ02	.	FQ20	12-20	100	1.000	42,59
HFQ03	.	FQ24	16-24	50	500	51,98
HFQ04	.	FQ30	18-30	50	500	70,02
HFQ05	.	FQ40	27-43	25	250	104,67



tubo de acero
steel tube

tubo de cobre
copper tube

tubo de PVC
PVC tube

FF

Abrazadera nylon, brida, rápida



POLIAMIDA 6.6

CÓDIGO CODE	MEDIDA SIZE	DESCR.	Ø TUBO Ø TUBE			€/ 100
HFF01	.	FF32	16-32	100	1.000	64,14
HFF02	.	FF63	40-63	50	500	112,96

CS

Abrazadera nylon, con tornillo



POLIAMIDA 6.6

CÓDIGO CODE	Ø	Ø TUBO Ø TUBE			€/ 100
* 38121	8	12	-	10	8,51
* 38122	8	14	-	10	8,51
* 38123	8	16	-	10	8,51
* 38124	10	18	-	10	11,03
* 38125	10	20	-	10	11,34
* 38126	10	22	-	10	11,76
* 38127	10	25	-	10	14,23
* 38128	10	28	-	10	14,25
* 38129	10	32	-	10	14,23

(*) HASTA FINAL DE EXISTENCIAS

CD

Abrazadera doble nylon, con tornillo



POLIAMIDA 6.6

CÓDIGO CODE	Ø	Ø TUBO Ø TUBE			€/ 100
* 38130	8	12	-	10	12,38
* 38131	8	14	-	10	12,58
* 38132	8	16	-	10	12,58
* 38133	10	18	-	10	15,26
* 38134	10	20	-	10	15,68
* 38135	10	22	-	10	16,40
* 38136	10	25	-	10	19,80
* 38137	10	28	-	10	19,80
* 38138	10	32	-	10	19,80

(*) HASTA FINAL DE EXISTENCIAS



Descarga

Descarga fichas técnicas y de seguridad, certificaciones, etc.



LEED®



TESTATO DA
"ISTITUTO POLITECNICO"
DI TORINO

TESTATO DA
"ISTITUTO GIORDANO
S.P.A."

Nuestras Certificaciones

Las Homologaciones dan fe de la calidad, alto rendimiento y fiabilidad de nuestros productos, garantizando una fijación segura en línea con las más estrictas Normativas Europeas

FIJACIONES GEBFIX-SOLAR PARA SISTEMAS FOTOVOLTAICOS

Anclajes, tornillos y accesorios
para la fijación de paneles fotovoltaicos



GB-SOLAR BLOCK

Accesorios para PANELES FOTOVOLTAICOS



GB-SOLAR BLOCK

SOPORTE fijación paneles, anti rayos UVA



SOLICITAR FICHA TÉCNICA

PATENTADO G&B



hormigón ligero aerated concrete ladrillo macizo solid brick madera wood

POLIAMIDA 6.6 con FIBRA DE VIDRIO

CÓDIGO CODE	MEDIDA SIZE	DESCR.	MAX.	RECOPRO	€/1
99001	120x47	GB-SOLAR BLOCK	-	150	8,30

Suministrado sin tornillo ni tuerca

GB-TER

Accesorio fijación extremos
INOX A2 AISI (304)



INOXIDABLE A2

CÓDIGO CODE	MEDIDA SIZE	RECOPRO	€/1
99193	15x40x35	1	3,00
99194	15x40x38	1	3,30
99195	15x40x42	1	3,80
99196	15x40x45	1	4,00
99197	15x40x48	1	4,30
99198	15x40x50	1	4,50

VDF

KIT TORNILLO, doble rosca
INOX A2 AISI (304)

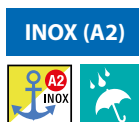
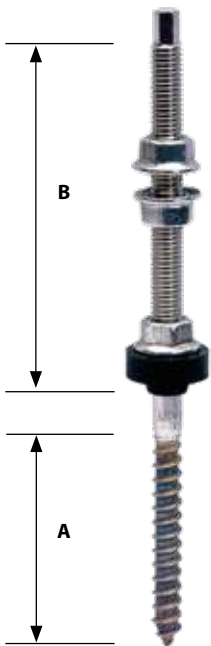

INOXIDABLE A2

CÓDIGO CODE	MEDIDA SIZE	DESCR.	A	B	RECOPRO	€/1
99002	M10x250	VDF1025	80	130	60	19,07
99003	M12x250	VDF1225	100	130	60	25,67
99004	M12x300	VDF1230	100	150	60	29,20
99005	M12x350	VDF1235	125	180	60	44,33

GB-SOLAR BLOCK

Accesorios para PANELES FOTOVOLTAICOS

GEBFIX SOLAR



TAP-N

ALFOMBRILLA para GB-SOLAR BLOCK

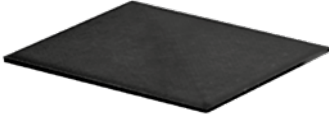

CÓDIGO CODE	MEDIDA SIZE	DESCR.		€/ 100
99164	180x80x1,5	TAP-N	150	340,00

P-11

PLETINA de conexión
INOX A2 (AISI-304)

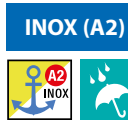

INOXIDABLE A2

CÓDIGO CODE	MEDIDA SIZE	DESCR.	OJAL BUTTONHOLE			€/ 100
99006	90x40x5	P11	13	10	100	740,00

Tornillo DIN-912

Tornillo CABEZA CILÍNDRICA, huella ALLEN
INOX A2 (AISI-304)

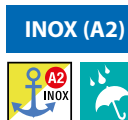

INOXIDABLE A2

CÓDIGO CODE	MEDIDA SIZE	DESCR.		€/ 100
99007	M8x10	TCEI810	100	39,06
99008	M8x20	TCEI820	100	40,09
99010	M8x25	TCEI825	100	46,50
99011	M8x30	TCEI830	100	50,32
99012	M8x35	TCEI835	100	52,55
99013	M8x40	TCEI840	100	68,46
99014	M8x45	TCEI845	100	56,83
99015	M8x50	TCEI850	100	61,43
99016	M8x55	TCEI855	100	94,96
99017	M8x65	TCEI865	100	77,45
99018	M8x70	TCEI870	100	66,86
99019	M10x20	TCEI1020	100	59,68
99020	M10x25	TCEI1025	100	63,29
99021	M10x40	TCEI1040	100	82,05

Tornillo DIN-933

TORNILLO HEXAGONAL, Rosca Total
INOX A2 (AISI-304)

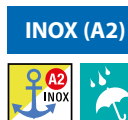

INOXIDABLE A2

CÓDIGO CODE	MEDIDA SIZE	DESCR.		€/ 100
99050	M6x35	TEI635	150	22,94
99051	M6x40	TEI640	150	30,17
99052	M6x45	TEI645	150	27,59
99053	M6x50	TEI650	150	24,54
99054	M6x60	TEI660	150	42,63
99055	M8x16	TEI816	100	46,29
99056	M8x20	TEI820	100	26,04
99057	M8x50	TEI850	100	71,61
99058	M10x20	TEI1020	100	41,85
99059	M10x30	TEI1030	100	51,20
99060	M10x50	TEI1050	100	70,42
99061	M10x60	TEI1060	50	93,00
99062	M10x70	TEI1070	50	95,84

Tornillo DIN-603

Tornillo CABEZA REDONDA,
CUELLO CUADRADO
INOX A2 (AISI-304)

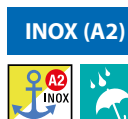

INOXIDABLE A2

CÓDIGO CODE	Ø	DESCR.		€/ 100
99071	M6x12	TTQ612	100	26,55
99072	M8x16	TTQ816	100	51,21
99073	M10x20	TTQ1020	50	61,02

GB-SOLAR BLOCK

Accesorios para PANELES FOTOVOLTAICOS

GEBFIX SOLAR



SOLICITAR FICHA TÉCNICA

Tuerca DIN-934 TUERCA HEXAGONAL INOX A2 (AISI-304)



INOXIDABLE A2

CÓDIGO CODE	Ø	DESCR.		€ / 100
99063	M6	DE6	200	6,17
99064	M8	DE8	200	12,51
99065	M10	DE10	100	27,90
99066	M12	DE12	50	40,90

Tuerca DIN-985 TUERCA AUTOBLOCANTE INOX A2 (AISI-304)



INOXIDABLE A2

CÓDIGO CODE	Ø	DESCR.		€ / 100
99067	M6	DEA6	150	8,82
99068	M8	DEA8	200	18,40
99069	M10	DEA10	100	37,02
99070	M12	DEA12	50	57,54

Tuerca DIN-6923 Tuerca hexagonal con BASE MOLTEADA INOX A2 (AISI-304)



INOXIDABLE A2

CÓDIGO CODE	MEDIDA SIZE	DESCR.	↕ MAX.		€ / 100
99038	M6	DEF6	-	150	13,70
99074	M8	DEF8	-	200	22,19
99075	M10	DEF10	-	100	42,98
99076	M12	DEF12	-	50	63,67

Tuerca ANTI-INTRUSIÓN Roscada, con agujero pasante INOX A2 (AISI-304)



INOXIDABLE A2

CÓDIGO CODE	X	DESCR.			€ / 100
91081	M8	DAT I M8	50	800	193,85
91082	M10	DAT I M10	50	800	324,99

Ø Ch	L mm	M	Ch mm.
	8	8	17
	8	10	19

Arandela DIN-125 Arandela PLANA INOX A2 (AISI-304)



INOXIDABLE A2

CÓDIGO CODE	X	DESCR.	Ø int.	Ø ext.	GROSOR THICKNESS		€ / 100
99077	M6	RP6	6,4	12	1,6	200	2,63
99078	M8	RP8	8,4	16	1,6	200	4,50
99079	M10	RP10	10,5	20	2	100	8,60
99080	M12	RP12	13	24	2,5	50	17,13

Arandela DIN-9021 Arandela ANCHA INOX A2 (AISI-304)



INOXIDABLE A2

CÓDIGO CODE	X	DESCR.	Ø int.	Ø ext.	GROSOR THICKNESS		€ / 100
99081	M6	RPL6	6,4	18	1,6	200	7,19
99082	M8	RPL8	8,4	24	2	200	14,82
99083	M10	RPL10	10,5	30	2,5	100	32,07
99084	M12	RPL12	13	37	3	50	55,31

GB-SOLAR BLOCK

Accesorios para PANELES FOTOVOLTAICOS

GEBFIX SOLAR



SOLICITAR FICHA TÉCNICA

STAGNO

REMACHE impermeable de aluminio/aluminio, cabeza plana, con junta EPDM

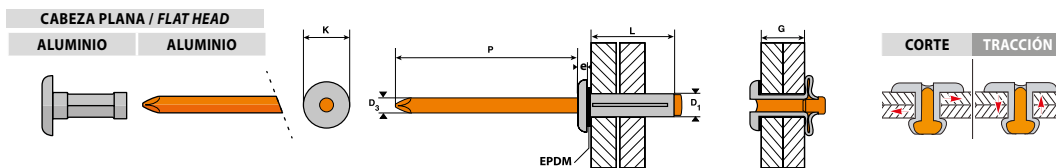

ALUMINIO / ALUMINIO



CÓDIGO CODE	D ₁	L	D ₂	G	Ø AGUJERO Ø HOLE	CORTE	TRACCIÓN			€/ 100
WED5222-BC	5,2	22,2	11,7	4,8x9,5	5,4	2.000	3.200	200	3.200	83,56

DIN-571 / TBA-INOX A2

Tornillo barraquero, CABEZA HEXAGONAL, INOX A2 (AISI 304)



INOXIDABLE A2

CÓDIGO CODE	MEDIDA SIZE				€/ 100
TBAI06040	6x40	10	100	2.400	28,83
TBAI06050	6x50	10	100	1.200	35,03
TBAI06060	6x60	10	100	1.200	41,93
TBAI06070	6x70	10	100	1.200	45,04
TBAI08050	8x50	13	100	1.200	65,34
TBAI08060	8x60	13	100	600	74,95
TBAI08070	8x70	13	100	600	86,50

INOXIDABLE A2

CÓDIGO CODE	MEDIDA SIZE				€/ 100
TBAI08080	8x80	13	100	600	92,65
TBAI08100	8x100	13	100	600	98,00
TBAI08120	8x120	13	100	600	130,00
TBAI10060	10x60	17	100	600	110,00
TBAI10080	10x80	17	100	400	162,03
TBAI10100	10x100	17	100	400	178,00
TBAI10120	10x120	17	50	300	215,00

DIN-7504-K / TBE-INOX

Tornillo autotaladrante, CABEZA HEXAGONAL, arandela estampada INOX A2 (AISI 304)



INOXIDABLE A2

CÓDIGO CODE	MEDIDA SIZE				€/ 100
TBEI4213	4,2x13	7	500	12.000	15,76
TBEI4216	4,2x16	7	500	12.000	17,68
TBEI4219	4,2x19	7	500	12.000	18,32
TBEI4813	4,8x13	8	250	6.000	22,29
TBEI4816	4,8x16	8	250	6.000	21,78
TBEI4819	4,8x19	8	250	6.000	23,57
TBEI4825	4,8x25	8	250	6.000	26,39
TBEI4832	4,8x32	8	250	6.000	31,38
TBEI4838	4,8x38	8	250	3.000	39,50
TBEI5519	5,5x19	8	250	6.000	32,54
TBEI5522	5,5x22	8	250	6.000	34,71
TBEI5525	5,5x25	8	250	6.000	36,89
TBEI5532	5,5x32	8	250	3.000	41,79
TBEI5538	5,5x38	8	250	3.000	46,32
TBEI6319	6,3x19	10	250	6.000	49,31
TBEI6325	6,3x25	10	250	3.000	56,10
TBEI6332	6,3x32	10	250	3.000	67,34
TBEI6338	6,3x38	10	250	3.000	73,94
TBEI6315	6,3x150	10	100	400	300,44

Arandela AR-NE

Arandela de estanqueidad vulcanizada, INOX A2 (AISI 304)



INOXIDABLE A2

CÓDIGO CODE	MEDIDA SIZE	DESCR.	X Ø		€/ 100
99035	Ø16x5,1	RIEPM4	4,8	200	30,21
99036	Ø19x6,1	RIEPM5	5,5	200	36,04
99037	Ø19x6,7	RIEPM6	6,3	100	28,44

FICHAS TÉCNICAS

TECHNICAL DATA SHEETS

DISPONEMOS DE INFORMACIÓN TÉCNICA DE TODOS NUESTROS PRODUCTOS
 WE HAVE TECHNICAL INFORMATION OF ALL OUR PRODUCTS

www.marefix.com

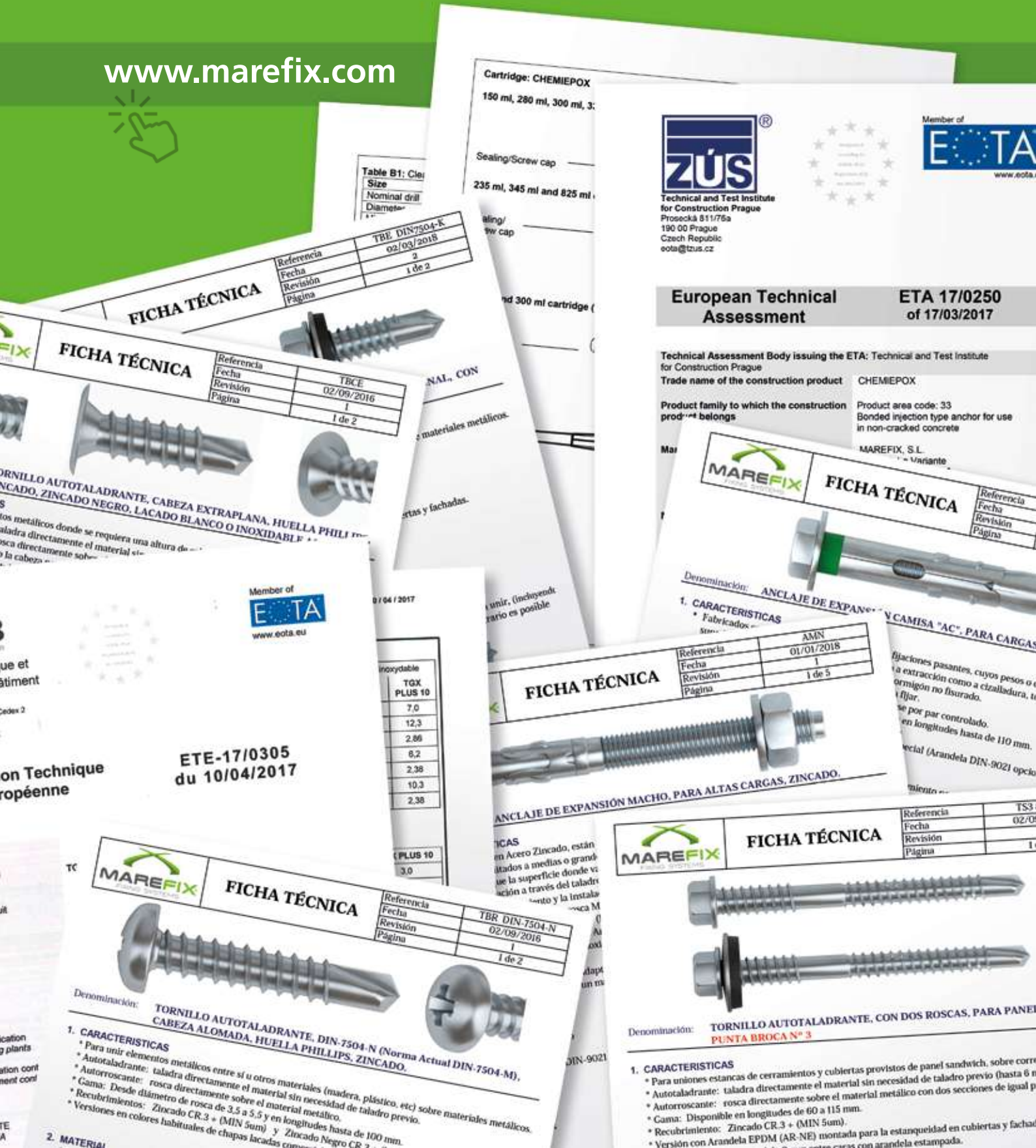

Table B1: Clear Size Nominal drill Diameter

Referencia	TBE DIN7504-K
Fecha	02/09/2018
Revisión	2
Página	1 de 2

FICHA TÉCNICA

FICHA TÉCNICA

Referencia	TBE
Fecha	02/09/2016
Revisión	1
Página	1 de 2



Technical and Test Institute for Construction Prague
 Prosecká 811/75a
 190 00 Prague
 Czech Republic
 eota@tzus.cz



Member of
ETA
 www.eota.eu

European Technical Assessment

ETA 17/0250 of 17/03/2017

Technical Assessment Body issuing the ETA: Technical and Test Institute for Construction Prague
 Trade name of the construction product: CHEMIEPOX
 Product family to which the construction product belongs: Bonded injection type anchor for use in non-cracked concrete
 Product area code: 33
 MAREFIX, S.L. - Variante



FICHA TÉCNICA

Referencia	
Fecha	
Revisión	
Página	

Denominación: ANCLAJE DE EXPANSIÓN MACHO, PARA ALTAS CARGAS, ZINCADO.

1. CARACTERÍSTICAS

Referencia	AMN
Fecha	01/01/2018
Revisión	1
Página	1 de 5

FICHA TÉCNICA



ANCLAJE DE EXPANSIÓN MACHO, PARA ALTAS CARGAS, ZINCADO.



Member of
ETA
 www.eota.eu

ETE-17/0305 du 10/04/2017

inoxidable	
TGX PLUS 10	
7,0	
12,3	
2,86	
8,2	
2,38	
10,3	
2,38	
PLUS 10	
3,0	



FICHA TÉCNICA

Referencia	TBR DIN-7504-N
Fecha	02/09/2016
Revisión	1
Página	1 de 2



Denominación: TORNILLO AUTOTALADRANTE, DIN-7504-N (Norma Actual DIN-7504-M), CABEZA ALOMADA, HUELLA PHILLIPS, ZINCADO.

1. CARACTERÍSTICAS

- * Para unir elementos metálicos entre sí u otros materiales (madera, plástico, etc) sobre materiales metálicos.
- * Autotaladrante: taladra directamente el material sin necesidad de taladro previo.
- * Autorroscante: rosca directamente sobre el material metálico.
- * Gama: Desde diámetro de rosca de 3,5 a 5,5 y en longitudes hasta de 100 mm.
- * Recubrimientos: Zincado CR.3 + (MIN 5um) y Zincado Negro CR.2
- * Versiones en colores habituales de chapas lacadas con...



FICHA TÉCNICA

Referencia	TS3
Fecha	02/09/2016
Revisión	1
Página	1 de 1



Denominación: TORNILLO AUTOTALADRANTE, CON DOS ROSCAS, PARA PANEL PUNTA BROCA Nº 3

1. CARACTERÍSTICAS

- * Para uniones estancas de cerramientos y cubiertas provistos de panel sandwich, sobre corre...
- * Autotaladrante: taladra directamente el material sin necesidad de taladro previo (hasta 6 m...
- * Autorroscante: rosca directamente sobre el material metálico con dos secciones de igual p...
- * Gama: Disponible en longitudes de 60 a 115 mm.
- * Recubrimiento: Zincado CR.3 + (MIN 5um).
- * Versión con Arandela EPDM (AR-NE) montada para la estanqueidad en cubiertas y fachad...

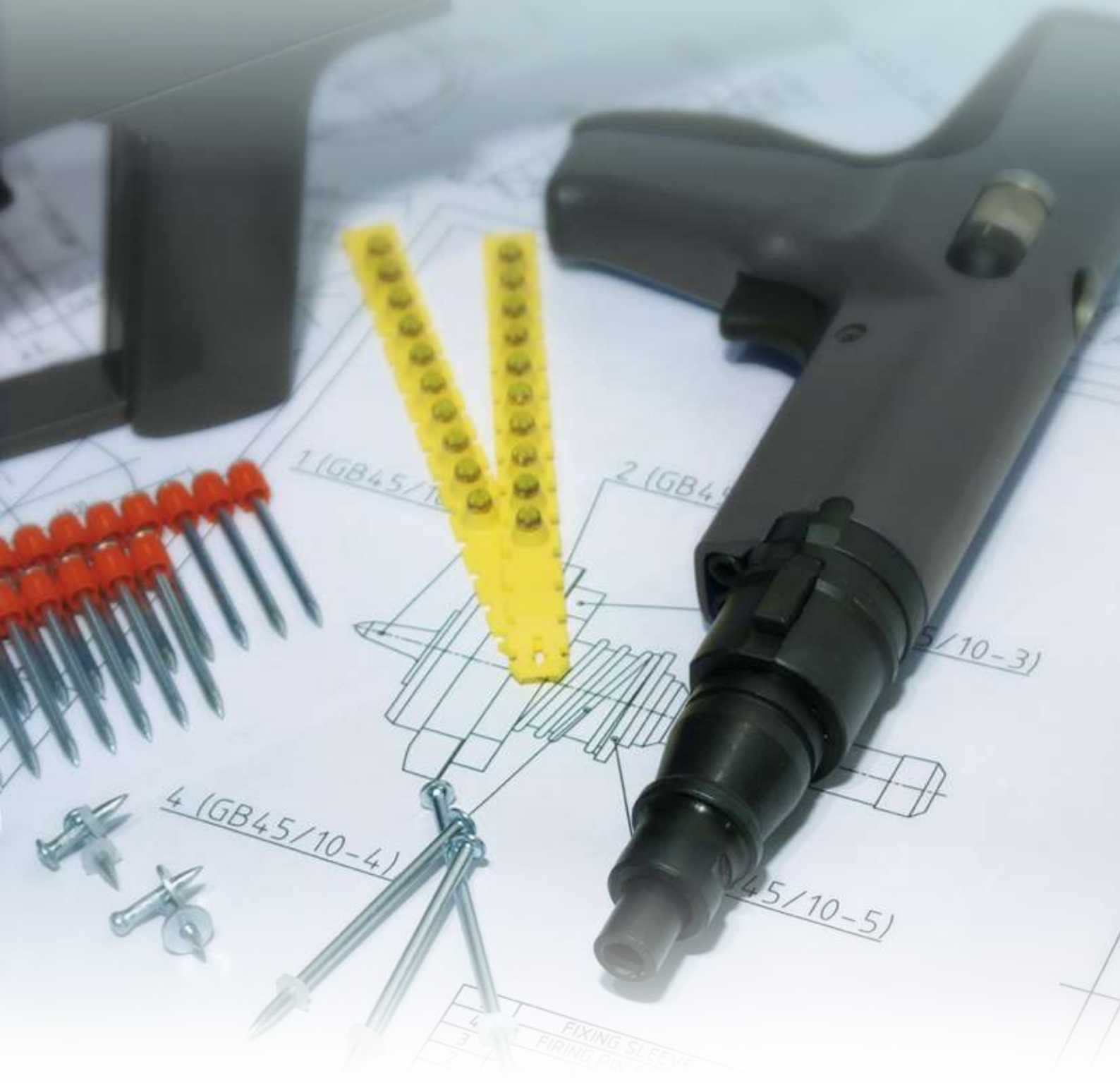

IMPULSIÓN A PÓLVORA



piedra stone hormigón concrete ladrillo macizo solid brick madera wood



SOLICITAR FICHA TÉCNICA

GB45 PISTOLA CLAVADORA

Carga automática de propulsores
regulación de potencia
Con **SILENCIADOR**, para un bajo impacto sonoro



Homologada CIP



CÓDIGO CODE	DESCR.			€/1
80010	GB45 CLAVADORA / NAIL GUN	1	1	1.970,06



CARGAS PARA PISTOLAS GB35 Y GB45



CÓDIGO CODE	DESCR.	COLOR COLOUR	POTENCIA POWER			€/100
80071	CARGA P3	VERDE / GREEN	3	100	10.000	61,74
80072	CARGA P4	AMARILLO / YELLOW	4	100	10.000	61,74
80073	CARGA P6	ROJO / RED	6	100	10.000	61,74
80074	CARGA P7	NEGRO / BLACK	7	100	10.000	69,23

CLAVO CABEZA Ø 8 mm. CON ARANDELA PLÁSTICA 8 mm.

Para clavadora GB35



CÓDIGO CODE	MEDIDA SIZE	DESCR.	VÁSTAGO STEM			€/100
80011	3,75x16	TCHIDN16	ESTRIADO / FLUTED	100	3.200	8,80
80012	3,75x19	TCHIDN19	ESTRIADO / FLUTED	100	2.000	14,90
80013	3,75x22	TCHIDN22	ESTRIADO / FLUTED	100	2.000	9,48
80014	3,75x27	TCHIDN27	LISO / SMOOTH	100	2.000	10,19
80015	3,75x32	TCHIDN32	LISO / SMOOTH	100	2.000	11,93
80016	3,75x37	TCHIDN37	LISO / SMOOTH	100	2.000	9,95
80017	3,75x42	TCHIDN42	LISO / SMOOTH	100	2.000	13,18
80018	3,75x47	TCHIDN47	LISO / SMOOTH	100	2.000	13,90
80019	3,75x52	TCHIDN52	LISO / SMOOTH	100	2.000	12,47
80102	3,75x57	TCHIDN57	LISO / SMOOTH	100	1.000	13,45
80079	3,75x62	TCHIDN62	LISO / SMOOTH	100	3.200	14,02
80081	3,75x72	TCHIDN72	LISO / SMOOTH	100	1.000	16,53

IMPULSIÓN A PÓLVORA



CLAVO CABEZA Ø8 mm.

En cargador de 10 unidades para clavadora con cargador



CÓDIGO CODE	MEDIDA SIZE	DESCR.	VÁSTAGO STEM			€/ 100
80020	3,75x16	TCHIK16	ESTRIADO / FLUTED	100	2.000	11,70
80021	3,75x19	TCHIK19	ESTRIADO / FLUTED	100	2.000	12,12
80022	3,75x22	TCHIK22	ESTRIADO / FLUTED	100	2.000	12,20
80023	3,75x27	TCHIK27	LISO / SMOOTH	100	2.000	12,44
80024	3,75x32	TCHIK32	LISO / SMOOTH	100	2.000	13,05
80065	3,75x42	TCHIK42	LISO / SMOOTH	100	2.000	15,58
80066	3,75x52	TCHIK52	LISO / SMOOTH	100	2.000	17,68
80067	3,75x62	TCHIK62	LISO / SMOOTH	100	2.000	20,29
80087	3,75x72	TCHIK72	LISO / SMOOTH	100	1.600	21,13

CLAVO CABEZA Ø6 mm. CON ARANDELA METÁLICA 12 mm.

Para clavadora GB45



CÓDIGO CODE	MEDIDA SIZE	DESCR.	VÁSTAGO STEM			€/ 100
80103	3,75x16	TCHINK16	ESTRIADO / FLUTED	100	2.000	13,06
80025	3,75x19	TCHINK19	ESTRIADO / FLUTED	100	2.000	13,37
80026	3,75x22	TCHINK22	LISO / SMOOTH	100	2.000	14,38
80027	3,75x27	TCHINK27	LISO / SMOOTH	100	2.000	15,12
80028	3,75x32	TCHINK32	LISO / SMOOTH	100	2.000	15,95
80029	3,75x37	TCHINK37	LISO / SMOOTH	100	2.000	16,87
80030	3,75x42	TCHINK42	LISO / SMOOTH	100	2.000	17,88
80031	3,75x47	TCHINK47	LISO / SMOOTH	100	2.000	20,39
80032	3,75x52	TCHINK52	LISO / SMOOTH	100	2.000	19,18
80104	3,75x57	TCHINK57	LISO / SMOOTH	100	1.000	18,41
80083	3,75x62	TCHINK62	LISO / SMOOTH	100	1.000	20,26
80084	3,75x72	TCHINK72	LISO / SMOOTH	100	1.600	20,71
80105	3,75x82	TCHINK82	LISO / SMOOTH	100	1.000	22,55
80106	3,75x97	TCHINK97	LISO / SMOOTH	100	1.000	48,39

INOX A2



AC-P



AC-AF



AC-GF



AFO



GFO





**ALTA
QUALITÀ
EUROPEA**



REMACHES



ensamblaje de chapas
metal panels

perfiles de chapa
metal elements

carpintería aluminio
aluminium windows



REM-NO

Remaches **CABEZA ALOMADA** de aluminio,
vástagos de acero



ZINCADO

CÓDIGO CODE	MEDIDA SIZE	Ø	MAX.			€/ 100
REMNO3206	3,2x6	3,30	1,5 - 3,5	500	6.000	3,41
REMNO3208	3,2x8	3,30	3,5 - 5,5	500	6.000	3,47
REMNO3210	3,2x10	3,30	5,5 - 7,0	500	6.000	3,69
REMNO3212	3,2x12	3,30	7,0 - 9,0	500	6.000	4,20
REMNO3214	3,2x14	3,30	9,0 - 11,0	500	6.000	4,30
REMNO3216	3,2x16	3,30	11,0 - 13,0	500	6.000	5,04
REMNO3218	3,2x18	3,30	13,0 - 15,0	500	6.000	5,18
REMNO4006	4,0x6	4,10	1,0 - 3,0	500	6.000	4,23
REMNO4008	4,0x8	4,10	3,0 - 5,0	500	6.000	4,42
REMNO4010	4,0x10	4,10	5,0 - 6,5	500	6.000	4,59
REMNO4012	4,0x12	4,10	6,5 - 8,5	500	6.000	5,47
REMNO4014	4,0x14	4,10	8,5 - 10,5	500	3.000	5,99
REMNO4016	4,0x16	4,10	10,5 - 12,5	500	3.000	6,58
REMNO4018	4,0x18	4,10	12,5 - 14,5	500	3.000	7,03
REMNO4020	4,0x20	4,10	14,5 - 16,5	500	3.000	7,26
REMNO4025	4,0x25	4,10	19,0 - 21,5	250	3.000	9,27
REMNO4030	4,0x30	4,10	21,5 - 26,0	250	3.000	12,90
REMNO4035	4,0x35	4,10	26,0 - 30,0	250	3.000	13,51
REMNO4806	4,8x6	4,90	1,0 - 3,0	500	6.000	5,66
REMNO4808	4,8x8	4,90	3,0 - 4,5	500	3.000	6,22
REMNO4810	4,8x10	4,90	4,5 - 6,0	500	3.000	6,34
REMNO4812	4,8x12	4,90	6,0 - 8,0	500	3.000	6,68
REMNO4814	4,8x14	4,90	8,0 - 10,0	250	3.000	7,88
REMNO4816	4,8x16	4,90	10,0 - 12,0	250	3.000	8,73
REMNO4818	4,8x18	4,90	12,0 - 14,0	250	3.000	9,46
REMNO4820	4,8x20	4,90	14,0 - 16,0	250	3.000	10,72
REMNO4822	4,8x22	4,90	16,0 - 18,0	200	2.400	11,78
REMNO4825	4,8x25	4,90	18,0 - 21,0	200	2.400	12,08
REMNO4830	4,8x30	4,90	21,0 - 25,0	200	2.400	15,14
REMNO4835	4,8x35	4,90	25,0 - 30,0	150	1.800	15,85
REMNO4840	4,8x40	4,90	30,0 - 35,0	150	1.800	15,68
REMNO4850	4,8x50	4,90	40,0 - 45,0	150	1.800	45,22
REMNO6008	6,0x8	6,10	2,0 - 4,0	250	3.000	15,13
REMNO6010	6,0x10	6,10	4,0 - 6,0	250	3.000	14,67
REMNO6012	6,0x12	6,10	6,0 - 8,0	250	3.000	15,06
REMNO6016	6,0x16	6,10	9,0 - 11,0	250	1.500	16,50
REMNO6018	6,0x18	6,10	11,0 - 13,0	200	1.200	17,15
REMNO6022	6,0x22	6,10	13,0 - 16,0	200	1.200	18,37
REMNO6026	6,0x26	6,10	16,0 - 20,0	200	1.200	21,14
REMNO6030	6,0x30	6,10	20,0 - 24,0	200	1.200	22,30



REM-CA

Remaches **CABEZA ANCHA** de aluminio,
vástagos de acero



ZINCADO

CÓDIGO CODE	MEDIDA SIZE	Ø	MAX.			€/ 100
REMCA4008	4,0x8 Ø12	4,10	3,0 - 5,0	500	3.000	6,57
REMCA4010	4,0x10 Ø12	4,10	5,0 - 6,5	500	3.000	7,12
REMCA4012	4,0x12 Ø12	4,10	6,5 - 8,5	250	3.000	8,39
REMCA4016	4,0x16 Ø12	4,10	10,5 - 12,5	250	3.000	9,59
REMCA4810	4,8x10 Ø16	4,90	3,5 - 6,0	250	3.000	10,23
REMCA4812	4,8x12 Ø16	4,90	6,0 - 8,0	250	3.000	10,74
REMCA4814	4,8x14 Ø16	4,90	8,0 - 10,0	250	3.000	11,66
REMCA4816	4,8x16 Ø16	4,90	10,0 - 12,0	250	1.500	12,48
REMCA4818	4,8x18 Ø16	4,90	12,0 - 14,0	200	2.400	13,30

REMACHES



ensamblaje de chapas
metal panels

perfiles de chapa
metal elements

carpintería aluminio
aluminium windows

REM-BL

Remaches cabeza alomada de aluminio, vástago de acero, **LACADO BLANCO**



LACADO BLANCO

CÓDIGO CODE	MEDIDA SIZE	Ø	MAX.			€ / 100
REMBL3208	3,2x8	3,30	3,5 - 5,5	500	6.000	6,83
REMBL3210	3,2x10	3,30	5,5 - 7,0	500	6.000	7,22
REMBL3212	3,2x12	3,30	7,0 - 9,0	500	6.000	7,58
REMBL4008	4,0x8	4,10	3,0 - 5,0	500	6.000	8,32
REMBL4010	4,0x10	4,10	5,0 - 6,5	500	6.000	9,01
REMBL4012	4,0x12	4,10	6,5 - 8,5	500	6.000	9,33
REMBL4016	4,0x16	4,10	10,5 - 12,5	500	3.000	11,00
REMBL4810	4,8x10	4,90	4,5 - 6,0	500	3.000	12,33
REMBL4812	4,8x12	4,90	6,0 - 8,0	500	3.000	12,97
REMBL4816	4,8x16	4,90	10,0 - 12,0	250	3.000	14,15

REM-NE

Remaches cabeza alomada de aluminio, vástago de acero, **LACADO NEGRO**



LACADO NEGRO

CÓDIGO CODE	MEDIDA SIZE	Ø	MAX.			€ / 100
REMNE3208	3,2x8	3,30	3,5 - 5,5	500	6.000	6,83
REMNE3210	3,2x10	3,30	5,5 - 7,0	500	6.000	7,22
REMNE3212	3,2x12	3,30	7,0 - 9,0	500	6.000	7,58
REMNE4008	4,0x8	4,10	3,0 - 5,0	500	6.000	8,32
REMNE4010	4,0x10	4,10	5,0 - 6,5	500	6.000	9,01
REMNE4012	4,0x12	4,10	6,5 - 8,5	500	6.000	9,33
REMNE4016	4,0x16	4,10	10,5 - 12,5	500	3.000	11,00
REMNE4810	4,8x10	4,90	4,5 - 6,0	500	3.000	12,33
REMNE4812	4,8x12	4,90	6,0 - 8,0	500	3.000	12,97
REMNE4816	4,8x16	4,90	10,0 - 12,0	250	3.000	14,15

REM-FL

Remaches cabeza alomada **FLOR** de aluminio, vástago de acero



ZINCADO

CÓDIGO CODE	MEDIDA SIZE	Ø	MAX.			€ / 100
REMFL4012	4,0x12	4,20	8,0	500	6.000	8,26
REMFL4014	4,0x14	4,20	10,0	500	3.000	9,35
REMFL4016	4,0x16	4,20	12,0	500	3.000	11,14
REMFL4018	4,0x18	4,20	14,0	500	3.000	11,56
REMFL4020	4,0x20	4,20	16,0	500	3.000	12,52
REMFL4025	4,0x25	4,20	21,0	250	3.000	14,50
REMFL4814	4,8x14	5,00	9,0	250	3.000	11,95
REMFL4816	4,8x16	5,00	11,0	250	3.000	13,39
REMFL4818	4,8x18	5,00	13,0	250	3.000	15,56
REMFL4824	4,8x24	5,00	19,0	200	2.400	16,93
REMFL4830	4,8x30	5,00	25,0	200	1.200	19,44
REMFL4835	4,8x35	5,00	30,0	150	1.800	23,05
REMFL4840	4,8x40	5,00	32,0	150	1.800	26,69
REMFL4845	4,8x45	5,00	37,0	150	900	33,37
REMFL4850	4,8x50	5,00	42,0	150	900	37,05



REMACHES



ensamblaje de chapas
metal panels

perfiles de chapa
metal elements

carpintería aluminio
aluminium windows

REM-INOX

Remaches cabeza alomada, todo **INOXIDABLE A2**



INOX (A2)



INOXIDABLE A2

CÓDIGO CODE	MEDIDA SIZE	Ø	MAX.			€/100
REM3206	3,2x6	3,30	0,5 - 3,5	500	6.000	13,34
REM3208	3,2x8	3,30	3,5 - 5,0	500	6.000	14,27
REM3212	3,2x10	3,30	5,0 - 7,0	500	6.000	21,03
REM3215	3,2x15	3,30	9,0 - 12,0	500	6.000	25,42
REM4008	4,0x8	4,10	3,0 - 5,0	500	6.000	23,96
REM4010	4,0x10	4,10	5,0 - 6,5	500	6.000	25,50
REM4012	4,0x12	4,10	6,5 - 8,5	500	6.000	28,90
REM4016	4,0x16	4,10	10,5 - 12,5	500	3.000	34,99
REM4810	4,8x10	4,90	4,5 - 6,0	500	3.000	35,25
REM4812	4,8x12	4,90	6,0 - 8,0	500	3.000	38,53
REM4816	4,8x16	4,90	10,0 - 12,0	250	3.000	47,37
REM4818	4,8x18	4,90	12,0 - 14,0	250	3.000	50,65
REM4820	4,8x20	4,90	13,5 - 15,0	250	3.000	66,47

REM-MAN

Remachadora **MANUAL**



CÓDIGO CODE	PARA ALUMINIO FOR ALUMINUM	PARA ACERO FOR STEEL	PARA INOXIDABLE FOR STAINLESS		€/1
REMANU	Ø2,4		Ø2,4	1	45,36
	Ø3,2	Ø3,2	Ø3,2		
	Ø4,0	Ø4,0	Ø4,0		
	Ø4,8				

REM-TIJ

Remachadora manual **TIJERA**



CÓDIGO CODE	PARA ALUMINIO FOR ALUMINUM	PARA ACERO FOR STEEL	PARA INOXIDABLE FOR STAINLESS		€/1
REMTIJ	Ø3,2	Ø3,2	Ø3,2	1	227,25
	Ø4,0	Ø4,0	Ø4,0		
	Ø4,8	Ø4,8	Ø4,8		
	Ø6,0	Ø6,0	Ø6,0		
	Ø6,4	Ø6,4	Ø6,4		

REM-EXT

Remachadora manual **EXTENSIBLE**



CÓDIGO CODE	PARA ALUMINIO FOR ALUMINUM	PARA ACERO FOR STEEL	PARA INOXIDABLE FOR STAINLESS		€/1
REMEXT	Ø3,2	Ø3,2	Ø3,2	1	177,39
	Ø4,0	Ø4,0	Ø4,0		
	Ø4,8	Ø4,8	Ø4,8		
	Ø6,0	Ø6,0	Ø6,0		
	Ø6,4	Ø6,4	Ø6,4		

REM-TUER

Remachadora manual **PARA TUERCAS REMACHABLES**



CÓDIGO CODE	PARA TUERCAS FOR NUTS		€/1
REMTUER	M04 - M10	1	173,78

REMACHES



ensamblaje de chapas
metal panels

perfiles de chapa
metal elements

carpintería aluminio
aluminium windows

TRE-AV

Tuerca remachable, **CABEZA AVELLANADA**



ZINCADO

CÓDIGO CODE	MEDIDA SIZE	∅	MAX.			€/ 100
TREAV0411	M-4x11,5	6	1,5 - 3,5	500	12.000	12,71
TREAV0513	M-5x13,5	7	1,5 - 4,0	500	6.000	13,64
TREAV0616	M-6x16,0	9	1,5 - 4,5	500	3.000	17,04
TREAV0819	M-8x19,0	11	1,5 - 4,5	250	3.000	19,94
TREAV1021	M-10x21,0	13	1,5 - 4,5	250	1.500	30,40

TRE-CA

Tuerca remachable, **CABEZA ANCHA**



ZINCADO

CÓDIGO CODE	MEDIDA SIZE	∅	MAX.			€/ 100
TRECA0310	M-3x10,9	5	0,5 - 3,0	500	12.000	8,86
TRECA0411	M-4x11,0	6	0,3 - 3,0	500	12.000	18,46
TRECA0412	M-4x12,5	6	3,1 - 4,0	500	12.000	18,46
TRECA0513	M-5x13,0	7	0,3 - 3,0	500	12.000	19,82
TRECA0516	M-5x16,0	7	3,1 - 4,0	500	6.000	19,82
TRECA0616	M-6x16,0	9	0,5 - 3,0	250	3.000	24,86
TRECA0617	M-6x17,5	9	3,1 - 4,5	250	3.000	24,86
TRECA0817	M-8x17,5	11	0,5 - 3,0	250	3.000	23,25
TRECA0820	M-8x20,0	11	3,1 - 5,5	250	1.500	19,04
TRECA1019	M-10x19,0	13	0,5 - 3,0	250	1.500	30,40
TRECA1024	M-10x24,0	13	3,1 - 6,0	250	1.500	31,47
TRECA1225	M-12x25,0	16	1,0 - 4,0	250	1.000	50,96

TRE-CR

Tuerca remachable, **CABEZA REDUCIDA**

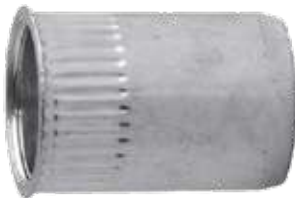

ZINCADO

CÓDIGO CODE	MEDIDA SIZE	∅	MAX.			€/ 100
TRECR0410	M-4x10,0	6	0,5 - 3,0	500	12.000	18,44
TRECR0511	M-5x11,5	7	0,5 - 3,0	500	12.000	18,64
TRECR0614	M-6x14,0	9	0,5 - 3,0	250	6.000	23,33
TRECR0815	M-8x15,5	11	0,5 - 3,0	250	3.000	27,16
TRECR1019	M-10x19,5	13	0,8 - 3,5	250	1.500	27,24





CONECTORES PARA MADERA

Anclaje cuadrado punta piramidal para enterrar, galvanizado en caliente



CÓDIGO CODE	MEDIDAS SIZE a x b x c x d		Nº AGUJEROS Nº HOLES		€/ 100
CM0001	71 x 71 x 150 x 750	1,80	4 x Ø11	1	2.801,46

GALVANIZADA EN CALIENTE



Base cuadrada para poste de madera, galvanizada en caliente

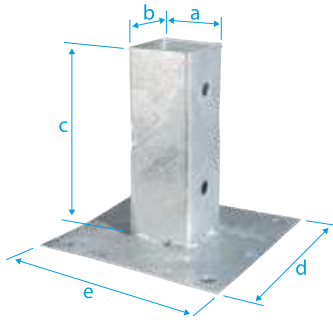

CÓDIGO CODE	MEDIDAS SIZE a x b x c x d x e		Nº AGUJEROS Nº HOLES		€/ 100
CM0010	71 x 71 x 150 x 150 x 150	1,80	4 x Ø11	1	2.085,61

GALVANIZADA EN CALIENTE



Anclaje en forma de "L", con barra de acero corrugado Ø19 soldada, galvanizado en caliente

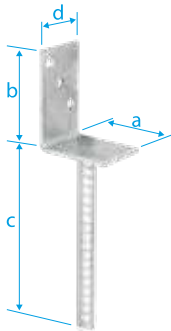

CÓDIGO CODE	MEDIDAS SIZE a x b x c x d		Nº AGUJEROS Nº HOLES		€/ 100
CM0020	80 x 100 x 200 x 60	4,00	3 x Ø11	1	2.260,62

GALVANIZADA EN CALIENTE

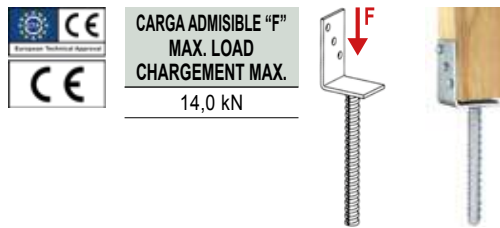

CARGA ADMISIBLE "F"
MAX. LOAD
CHARGEMENT MAX.
14,0 kN

Anclaje en forma de "U", con barra de acero corrugado Ø19 soldada, galvanizado en caliente

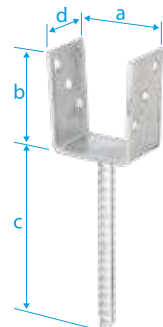

CÓDIGO CODE	MEDIDAS SIZE a x b x c x d		Nº AGUJEROS Nº HOLES		€/ 100
CM0030	71 x 100 x 200 x 60	4,00	6 x Ø11	1	2.851,41
CM0035	91 x 100 x 200 x 60	4,00	6 x Ø11	1	2.925,38
CM0040	101 x 100 x 200 x 60	4,00	6 x Ø11	1	3.024,04

GALVANIZADA EN CALIENTE

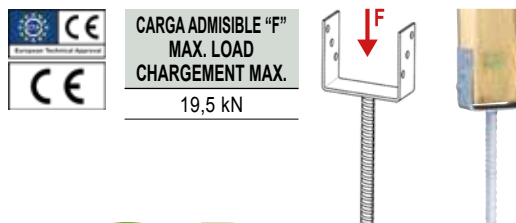

CARGA ADMISIBLE "F"
MAX. LOAD
CHARGEMENT MAX.
19,5 kN

CONECTORES PARA MADERA

Anclaje en forma de "U", para atornillar directamente, galvanizado en caliente

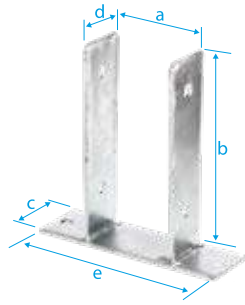

CÓDIGO CODE	MEDIDAS SIZE a x b x c x d x e		Nº AGUJEROS Nº HOLES		€ / 100
CM0050	71 x 200 x 60 x 50 x 200	5,00	6 x ø11	1	3.209,51
CM0055	91 x 200 x 60 x 50 x 200	5,00	6 x ø11	1	3.336,73
CM0060	101 x 200 x 60 x 50 x 200	5,00	6 x ø11	1	3.438,88

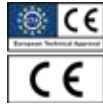

GALVANIZADA EN CALIENTE

Soporte para poste, simétrico, galvanizado en caliente

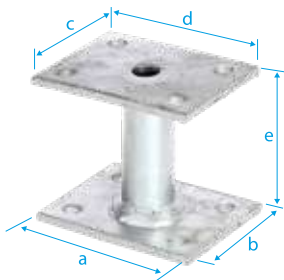

CÓDIGO CODE	MEDIDAS SIZE a x b x c x d x e		Nº AGUJEROS Nº HOLES		€ / 100
CM0070	70 x 90 x 70 x 80 x 90	5,00	8 x ø11	1	3.180,11
CM0075	100 x 100 x 100 x 100 x 100	5,00	8 x ø11	1	4.788,55



CARGA ADMISIBLE "F"
MAX. LOAD
CHARGEMENT MAX.
24,5 kN

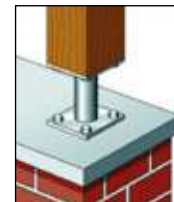
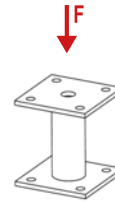

GALVANIZADA EN CALIENTE

Soporte para poste, asimétrico, galvanizado en caliente

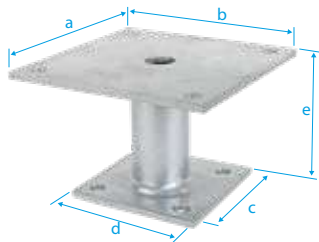

CÓDIGO CODE	MEDIDAS SIZE a x b x c x d x e		Nº AGUJEROS Nº HOLES		€ / 100
CM0080	150 x 150 x 100 x 100 x 100	4,00	8 x ø11	1	4.375,33



CARGA ADMISIBLE "F"
MAX. LOAD
CHARGEMENT MAX.
24,5 kN

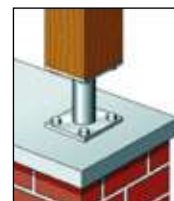
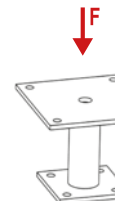

GALVANIZADA EN CALIENTE

Anclaje para poste, altura regulable (30-150 mm), espárrago M20, zincado

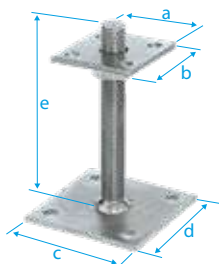

CÓDIGO CODE	MEDIDAS SIZE a x b x c x d x e		Nº AGUJEROS Nº HOLES		€ / 100
CM0090	70 x 70 x 100 x 100 x 150	5,00	8 x ø11	1	4.842,20
CM0095	150 x 150 x 100 x 100 x 150	5,00	8 x ø11	1	5.693,44



CARGA ADMISIBLE "F"
MAX. LOAD
CHARGEMENT MAX.
18,5 kN

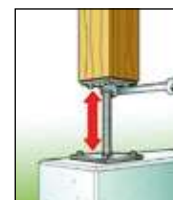
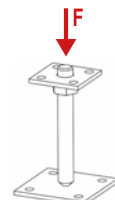

GALVANIZADA EN CALIENTE

CONECTORES PARA MADERA

Anclaje para poste en forma de "U", ancho regulable, zincado

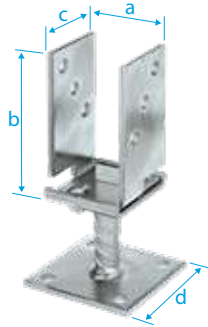

CÓDIGO CODE	MEDIDAS SIZE a x b x c x d		Nº AGUJEROS Nº HOLES		€/ 100
CM0100	71-131 x 110 x 70 x 100	5,00	10 x Ø11	1	4.767,54



CARGA ADMISIBLE "F"
MAX. LOAD
CHARGEMENT MAX.
18,5 kN

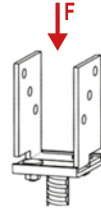

GALVANIZADA EN CALIENTE

Anclaje para poste en forma de "U", ancho regulable, barra acero corrugado Ø19, zincado

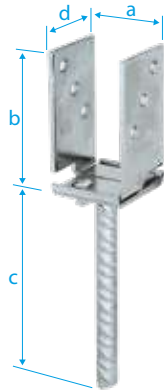

CÓDIGO CODE	MEDIDAS SIZE a x b x c x d		Nº AGUJEROS Nº HOLES		€/ 100
CM0110	71-131 x 110 x 200 x 70	5,00	6 x Ø11	1	4.665,48



CARGA ADMISIBLE "F"
MAX. LOAD
CHARGEMENT MAX.
18,5 kN

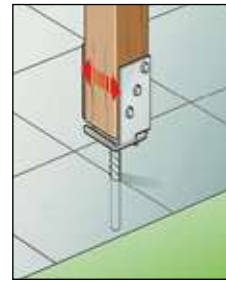
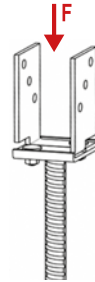

GALVANIZADA EN CALIENTE

Escuadra en forma de "L", para celosías con tornillo rosca madera 9 x 45 mm soldado, zincado

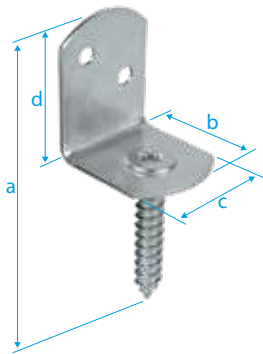

CÓDIGO CODE	MEDIDAS SIZE a x b x c x d		Nº AGUJEROS Nº HOLES		€/ 100
CM0120	83 x 32 x 30 x 38	2,00	2 x Ø5,0	50	198,54



GALVANIZADA EN CALIENTE

Pletina de ensamblaje galvanizada Sendzimir

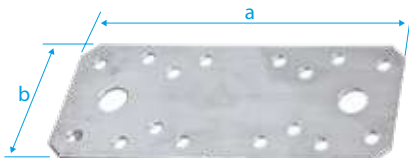

CÓDIGO CODE	a	b		Nº AGUJEROS Nº HOLES	Nº AGUJEROS Nº HOLES		€/ 100
CM0130	100	35	2,50	2 / 12	11 / 4,5	50	156,65
CM0135	135	55	2,50	2 / 14	11 / 5	50	377,86



GALVANIZADO SENDZIMIR

CONECTORES PARA MADERA



madera
wood

Escuadra de ensamble,
galvanizada Sendzimir

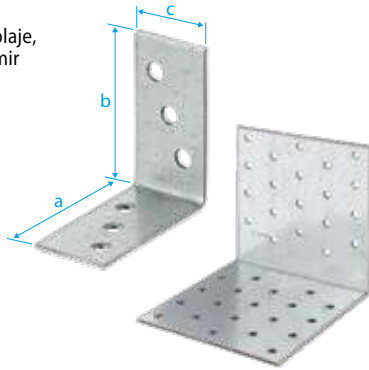

CÓDIGO CODE	MEDIDAS SIZE a x b x c		Nº AGUJEROS Nº HOLES		€/ 100
CM0145	40 x 40 x 20	2,00	6 / ø 4,5	100	77,50
CM0150	40 x 40 x 40	2,00	8 / ø 4,5	50	138,04
CM0155	40 x 40 x 60	2,50	12 / ø 5,0	50	219,39
CM0160	50 x 50 x 40	2,00	8 / ø 4,5	50	162,85
CM0165	60 x 60 x 40	2,50	12 / ø 4,5	50	223,24
CM0170	60 x 60 x 60	2,50	16 / ø 4,5	50	283,53
CM0175	60 x 60 x 80	2,50	20 / ø 4,5	25	488,38
CM0180	80 x 80 x 40	2,00	12 / ø 5,0	50	284,21
CM0185	80 x 80 x 80	2,50	28 / ø 4,5	25	570,79
CM0190	100 x 100 x 40	2,00	15 / ø 5,0	50	351,75
CM0195	100 x 100 x 100	2,50	40 / ø 4,5	25	906,58



GALVANIZADO SENDZIMIR

Escuadra de ensamble,
galvanizada
y plastificada blanca

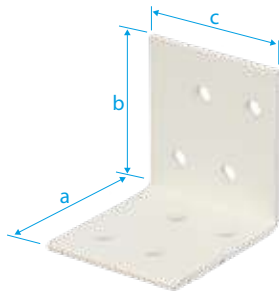

CÓDIGO CODE	MEDIDAS SIZE a x b x c		Nº AGUJEROS Nº HOLES		€/ 100
CM0200	40 x 40 x 40	2,00	8 / ø 4,5	50	237,04
CM0205	50 x 50 x 40	2,00	8 / ø 4,5	50	250,85
* CM0210	60 x 60 x 40	2,50	12 / ø 4,5	50	344,35
CM0215	60 x 60 x 60	2,50	16 / ø 4,5	50	462,92



(*) HASTA FINAL DE EXISTENCIAS

Escuadra de ensamble,
con lados iguales,
galvanizada Sendzimir

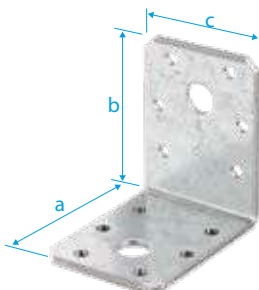

CÓDIGO CODE	MEDIDAS SIZE a x b x c		Nº AGUJEROS Nº HOLES		€/ 100
CM0220	50 x 50 x 35	2,50	2/11,0 - 12/3,5	50	139,21
CM0225	60 x 60 x 45	2,50	2/11,0 - 12/4,5	50	247,35
CM0230	70 x 70 x 55	2,50	2/11,0 - 16/4,5	50	284,00
CM0235	90 x 90 x 40	3,00	4/11,0 - 16/4,5	50	343,45
CM0240	90 x 90 x 65	2,50	2/12,0-12/7,5-16/4,5	25	371,72
CM0245	100 x 100 x 90	3,00	2/14,0 - 28/7,5	25	769,44



GALVANIZADO SENDZIMIR

Escuadra de ensamble, con lados
desiguales, galvanizada Sendzimir

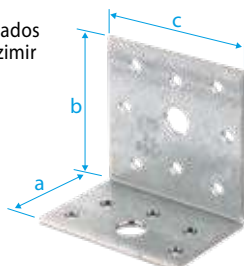

CÓDIGO CODE	MEDIDAS SIZE a x b x c		Nº AGUJEROS Nº HOLES		€/ 100
CM0250	40 x 60 x 60	2,50	2/11,0 - 13/5,0	50	328,57
CM0255	60 x 80 x 60	2,50	3/11,0 - 18/5,0	50	439,30



GALVANIZADO SENDZIMIR

CONECTORES PARA MADERA



madera
wood

Escuadra grande de ángulo, galvanizada Sendzimir

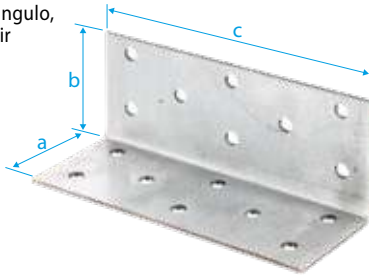

CÓDIGO CODE	MEDIDAS SIZE a x b x c		Nº AGUJEROS Nº HOLES		€ / 100
CM0260	40 x 40 x 100	2,00	16 / 4,5	25	353,20

GALVANIZADO SENDZIMIR



Escuadra reforzada, galvanizada Sendzimir

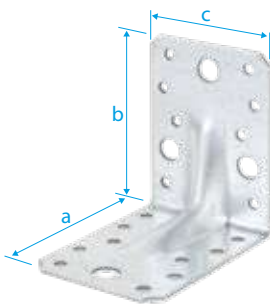

CÓDIGO CODE	MEDIDAS SIZE a x b x c		Nº AGUJEROS Nº HOLES		€ / 100
CM0270	70 x 70 x 55	2,50	2/11,0 - 16/4,5	50	305,53
CM0275	90 x 90 x 65	2,50	2/11,0-12/7,5-16/4,5	25	372,66
CM0280	100 x 100 x 90	3,00	2/14,0 - 36/4,5	20	731,55

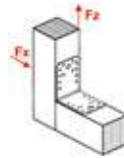

CÓDIGO	FUERZA MÁX. "Fx" MAX STRENGTH "Fx"	FUERZA MÁX. "Fz" MAX STRENGTH "Fz"
CM0270	2,30 kN	2,00 kN
CM0275	3,10 kN	2,80 kN
CM0280	3,80 kN	3,50 kN



GALVANIZADO SENDZIMIR

Escuadra regulable, galvanizada Sendzimir

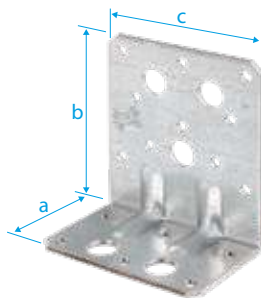

CÓDIGO CODE	MEDIDAS SIZE a x b x c		Nº AGUJEROS Nº HOLES		€ / 100
CM0310	90 x 50 x 50	2,50	3/13,0 - 10/5,0	50	330,45
CM0315	90 x 90 x 80	4,50	5/13,0 - 16/5,0	50	478,39

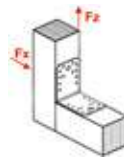

CÓDIGO	FUERZA MÁX. "Fx" MAX STRENGTH "Fx"	FUERZA MÁX. "Fz" MAX STRENGTH "Fz"
CM0310	2,00 kN	1,50 kN
CM0315	2,50 kN	2,20 kN



GALVANIZADO SENDZIMIR

Escuadra regulable, galvanizada Sendzimir

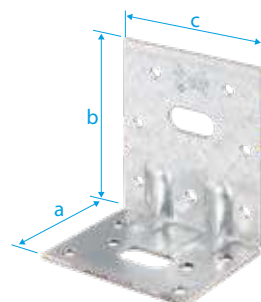

CÓDIGO CODE	MEDIDAS SIZE a x b x c		Nº AGUJEROS Nº HOLES		€ / 100
CM0330	77 x 64 x 50	2,00	13 / 5,0	50	337,59

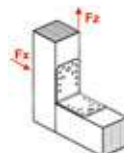

FUERZA MÁX. "Fx" MAXIMUM STRENGTH	FUERZA MÁX. "Fz" MAX STRENGTH "Fz"
2,20 kN	2,00 kN



GALVANIZADO SENDZIMIR

CONECTORES PARA MADERA

Escuadra reforzada, galvanizada Sendzimir

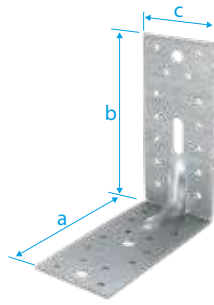

CÓDIGO CODE	MEDIDAS SIZE a x b x c		Nº AGUJEROS Nº HOLES		€ / 100
CM0350	150 x 150 x 65	2,50	3/11,0 - 28/5,0	25	749,66

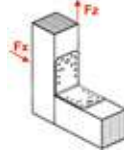

FUERZA MÁX. "Fx" MAX STRENGTH "Fx"	FUERZA MÁX. "Fz" MAX STRENGTH "Fz"
4,20 kN	3,80 kN



GALVANIZADO SENDZIMIR

Escuadra asimétrica, galvanizada Sendzimir, derecha o izquierda

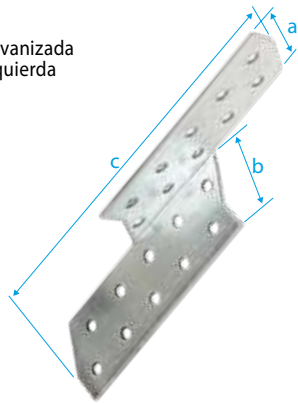

CÓDIGO CODE	MEDIDAS SIZE a x b x c		Nº AGUJEROS Nº HOLES		€ / 100
CM0360	32 x 32 x 170 D/R/D	→ 2,00	20 / 5,0	25	220,84
CM0365	32 x 32 x 170 I/G/L	← 2,00	20 / 5,0	25	220,84



GALVANIZADO SENDZIMIR

Soporte perforado en "U" con alas exteriores y orificios de sellado, galvanizado Sendzimir

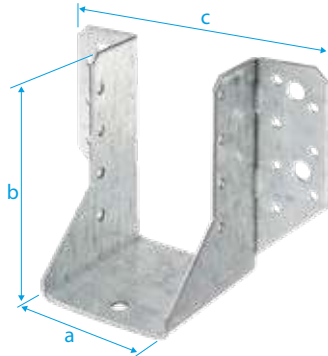

CÓDIGO CODE	MEDIDAS SIZE a x b x c		Nº AGUJEROS Nº HOLES		€ / 100
CM0370	40 x 110 x 110	2,00	4/9,0 - 22/5,0	25	670,93
CM0375	60 x 100 x 138	2,00	4/9,0 - 22/5,0	25	624,40
CM0380	70 x 125 x 140	2,00	4/13,0 - 26/5,0	25	792,23
CM0385	80 x 120 x 150	2,00	4/11,0 - 28/5,0	25	710,90
CM0390	100 x 140 x 170	2,00	4/11,0 - 34/5,0	25	915,13

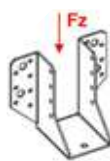

CÓDIGO	FUERZA MÁX. "Fz" MAX STRENGTH "Fz"
CM0370	3,30 kN
CM0375	3,80 kN
CM0380	4,30 kN
CM0385	4,80 kN
CM0390	6,00 kN



GALVANIZADO SENDZIMIR



Soporte perforado en "U" con ancho variable y orificios de sellado, galvanizado Sendzimir

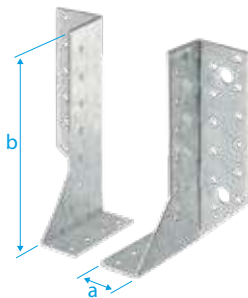

CÓDIGO CODE	MEDIDAS SIZE a x b		Nº AGUJEROS Nº HOLES		€ / 100
CM0400	25 x 140 D/R/D	→ 2,00	20 / 4,80	25	521,97
CM0405	25 x 140 I/G/L	← 2,00	20 / 4,80	25	521,97



GALVANIZADO SENDZIMIR

CONECTORES PARA MADERA



madera
wood

Pletina de ensamble galvanizada Sendzimir



CÓDIGO CODE	MEDIDAS SIZE a x b		Nº AGUJEROS Nº HOLES		€/ 100
CM0420	120 x 40	2,00	9 / 5,00	50	175,12
CM0425	160 x 40	2,00	12 / 5,00	50	252,62
CM0430	200 x 60	2,00	2/11,0 - 26/5,0	25	392,66
CM0435	240 x 60	2,00	2/11,0 - 32/4,5	25	451,30
CM0440	200 x 80	2,00	2/11,0 - 40/5,0	25	505,49
CM0445	240 x 80	2,00	2/11,0 - 48/5,0	25	671,21

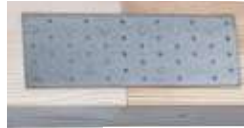

GALVANIZADO SENDZIMIR

Escuadra para cemento, galvanizada Sendzimir

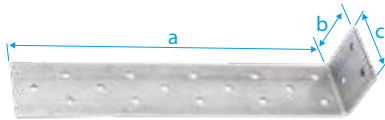

CÓDIGO CODE	MEDIDAS SIZE a x b x c		Nº AGUJEROS Nº HOLES		€/ 100
CM0460	200 x 40 x 40	2,00	18 / 4,50	10	360,39



GALVANIZADO SENDZIMIR

Pletina de ensamble "T", galvanizada Sendzimir

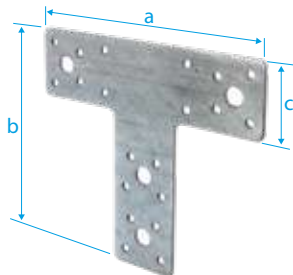

CÓDIGO CODE	MEDIDAS SIZE a x b x c		Nº AGUJEROS Nº HOLES		€/ 100
CM0470	160 x 142 x 45	2,50	4/11,0 - 20/4,5	20	1.651,62



GALVANIZADO SENDZIMIR

Cinta perforada galvanizada Sendzimir

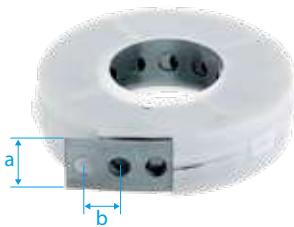

CÓDIGO CODE	MEDIDAS SIZE a x b x c		Nº AGUJEROS Nº HOLES		€/ 100
CM0480	20 x 12 x 3.000	1,00	7,00	5	2.147,18



GALVANIZADO SENDZIMIR



madera wood hormigón concrete hormigón ligero aerated concrete hormigón hueco concrete hollow

Puntas de fijación, galvanizadas Sendzimir

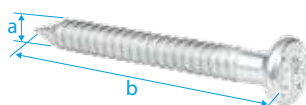

CÓDIGO CODE	MEDIDAS SIZE a x b		€/ 100
CM0490	4 x 40	50	30,38
CM0495	4 x 50	50	32,90

GALVANIZADO SENDZIMIR

CONECTORES PARA MADERA



madera
wood

Pletina de unión, zincada, orificios avellanados en ambas caras



CÓDIGO CODE	MEDIDAS SIZE a x b		Nº AGUJEROS Nº HOLES		€ / 100
CM0500	50 x 14	1,75	4 / 4,50	100	73,52
CM0505	60 x 14	1,75	4 / 4,50	100	85,22
CM0510	80 x 15	1,75	4 / 4,50	100	91,43
CM0515	100 x 15	1,75	4 / 4,50	100	103,60
CM0520	120 x 16	1,75	4 / 5,50	100	116,71

Escuadra para silla zincada, orificios avellanados en ambas caras

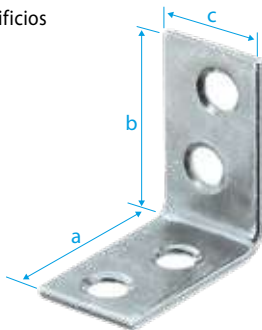

CÓDIGO CODE	MEDIDAS SIZE a x b x c		Nº AGUJEROS Nº HOLES		€ / 100
CM0530	25 x 25 x 14	1,75	4 / 4,50	100	51,52
CM0535	30 x 30 x 14	1,75	4 / 4,50	100	73,99
CM0540	40 x 40 x 15	1,75	4 / 4,50	100	86,16
CM0545	50 x 50 x 15	1,75	4 / 4,50	100	92,60
CM0550	60 x 60 x 16	1,75	4 / 5,50	100	104,77
CM0555	75 x 75 x 16	1,75	4 / 5,50	50	135,23
CM0560	90 x 90 x 19	2,00	6 / 5,30	50	166,01
CM0565	100 x 100 x 19	2,00	6 / 5,30	40	200,25
CM0570	125 x 125 x 22	2,00	6 / 6,00	40	300,68
CM0575	150 x 150 x 25	3,00	6 / 6,50	20	440,90

Escuadra para silla, orificios avellanados en ambas caras, plastificada blanco

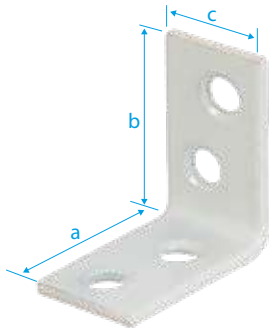

CÓDIGO CODE	MEDIDAS SIZE a x b x c		Nº AGUJEROS Nº HOLES		€ / 100
CM0590	40 x 40 x 15	1,75	4 / 4,50	50	152,54
CM0595	60 x 60 x 16	1,75	4 / 5,50	50	188,35

Escuadra para silla zincada, (unidas por una brida de nylon)



CÓDIGO CODE	MEDIDAS SIZE a x b x c		Nº AGUJEROS Nº HOLES		€ / KIT
CM0610	25 x 25 x 14 / 12 Unid.	1,75	4 / 4,50	10	6,43
CM0615	30 x 30 x 14 / 12 Unid.	1,75	4 / 4,50	10	7,16
CM0620	40 x 40 x 15 / 12 Unid.	1,75	4 / 4,50	10	8,12
CM0625	50 x 50 x 15 / 12 Unid.	1,75	4 / 4,50	10	9,77
CM0630	60 x 60 x 16 / 8 Unid.	1,75	4 / 5,50	10	9,13
CM0635	75 x 75 x 16 / 8 Unid.	1,75	4 / 5,50	10	11,45



CONECTORES PARA MADERA



madera
wood

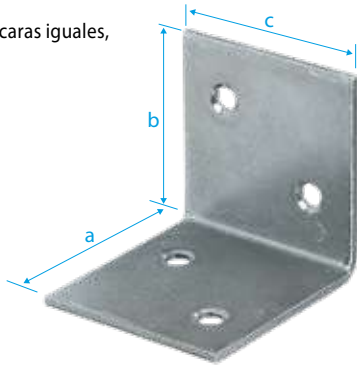

Escuadra grande de caras iguales, zincada

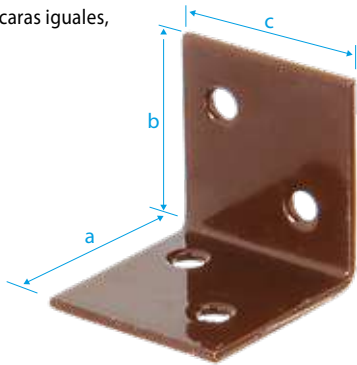

CÓDIGO CODE	MEDIDAS SIZE a x b x c		Nº AGUJEROS Nº HOLES		€ / 100
CM0650	30 x 30 x 30	2,00	4 / 5,00	100	116,71
CM0655	40 x 40 x 40	2,00	4 / 5,00	50	138,04
CM0660	60 x 60 x 60	2,00	8 / 5,00	50	277,90

Escuadra grande de caras iguales, plastificada marrón





CÓDIGO CODE	MEDIDAS SIZE a x b x c		Nº AGUJEROS Nº HOLES		€ / 100
* CM0670	30 x 30 x 30	2,00	4 / 5,00	50	281,38
* CM0675	40 x 40 x 40	2,00	4 / 5,00	50	369,51
* CM0680	60 x 60 x 60	2,00	8 / 5,00	50	499,31

(*) HASTA FINAL DE EXISTENCIAS;

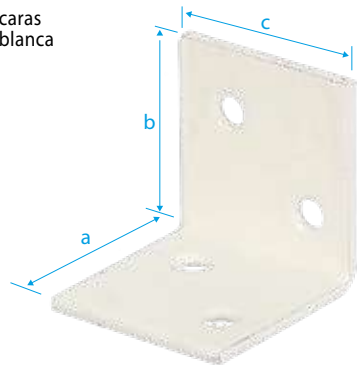

Escuadra grande de caras iguales, plastificada blanca

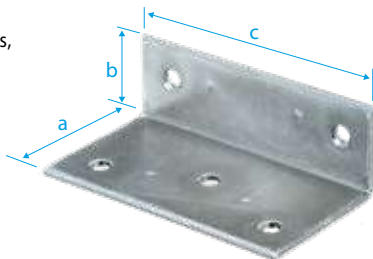

CÓDIGO CODE	MEDIDAS SIZE a x b x c		Nº AGUJEROS Nº HOLES		€ / 100
CM0690	30 x 30 x 30	2,00	4 / 5,00	50	281,38
CM0695	40 x 40 x 40	2,00	4 / 5,00	50	369,51

Escuadra grande de caras desiguales, zincada



CÓDIGO CODE	MEDIDAS SIZE a x b x c		Nº AGUJEROS Nº HOLES		€ / 100
CM0700	40 x 25 x 75	2,00	5 / 4,80	50	214,93



CONECTORES PARA MADERA



madera
wood



Pletina en "T", galvanizada
Sendzimir

CÓDIGO CODE	MEDIDAS SIZE a x b x c		Nº AGUJEROS Nº HOLES		€ / 100
CM0710	50 x 70 x 16	2,00	6 / 3,80	50	132,65
CM0715	110 x 140 x 30	2,00	6 / 5,00	25	324,41

GALVANIZADO SENDZIMIR



Escuadra regulable,
zincada

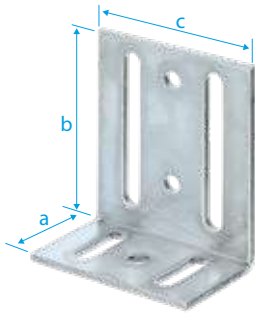

CÓDIGO CODE	MEDIDAS SIZE a x b x c		Nº AGUJEROS Nº HOLES		€ / 100
CM0720	40 x 77 x 65	3,00	3/7 - 2/7x60 - 2/7x25	25	565,72



Escuadra para poste de caras
desiguales, zincada

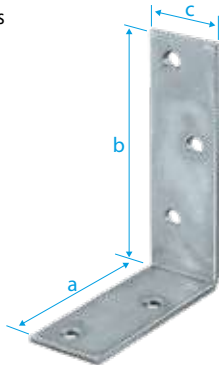

CÓDIGO CODE	MEDIDAS SIZE a x b x c		Nº AGUJEROS Nº HOLES		€ / 100
CM0730	75 x 100 x 30	3,00	5 / 5,50	50	321,67
CM0735	80 x 120 x 35	4,00	7 / 7,00	25	525,96

Escuadra para empotrar
regulable, zincada



CÓDIGO CODE	MEDIDAS SIZE a x b x c		Nº AGUJEROS Nº HOLES		€ / 100
CM0740	25 x 25 x 30	1,25	1/5,00x15 - 2/5,00	50	151,60



CONECTORES PARA MADERA

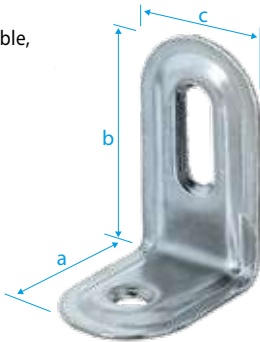

madera
wood

Escuadra para empotrar regulable, zincada





CÓDIGO CODE	MEDIDAS SIZE a x b x c		Nº AGUJEROS Nº HOLES		€ / 100
CM0750	28 x 40 x 22	1,00	1/4,50x16 - 1/4,50	50	129,36



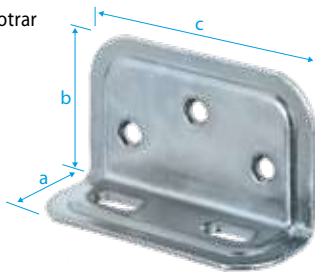

Escuadra grande para empotrar regulable, zincada



CÓDIGO CODE	MEDIDAS SIZE a x b x c		Nº AGUJEROS Nº HOLES		€ / 100
CM0760	25 x 40 x 70	1,50	2/5,0x12 - 3/5,0	20	264,27

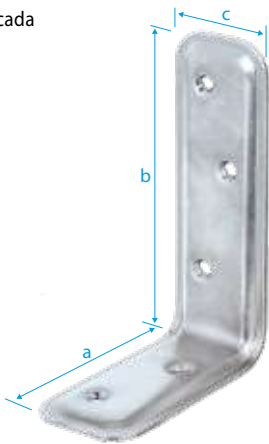

Escuadra para empotrar, zincada



CÓDIGO CODE	MEDIDAS SIZE a x b x c		Nº AGUJEROS Nº HOLES		€ / 100
CM0770	80 x 120 x 40	2,00	5 / 4,50	20	463,35
CM0775	100 x 160 x 40	2,00	5 / 4,50	20	627,19

Pletina para empotrar, zincada



CÓDIGO CODE	MEDIDAS SIZE a x b		Nº AGUJEROS Nº HOLES		€ / 100
CM0780	180 x 40	2,00	6 / 4,50	20	433,03

CONECTORES PARA MADERA



madera
wood

Escuadra de silla embutida, plastificada blanca



CÓDIGO CODE	MEDIDAS SIZE a x b x c		Nº AGUJEROS Nº HOLES		€ / 100
* CM0790	30 x 30 x 20	1,00	2 / 5,30	20	239,56
CM0795	50 x 50 x 20	1,00	4 / 5,30	20	334,23
CM0800	75 x 75 x 20	1,00	4 / 5,30	10	363,28
CM0805	103 x 103 x 21	2,00	6 / 5,00	10	554,86
CM0810	130 x 130 x 21	1,50	6 / 5,00	10	724,65

(*) HASTA FINAL DE EXISTENCIAS

Escuadra de silla embutida, plastificada gris aluminio

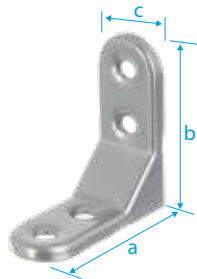

CÓDIGO CODE	MEDIDAS SIZE a x b x c		Nº AGUJEROS Nº HOLES		€ / 100
CM0820	50 x 50 x 20	1,00	4 / 5,30	20	334,94
CM0825	75 x 75 x 20	1,00	4 / 5,30	10	363,28
CM0830	103 x 103 x 21	2,00	6 / 5,00	10	554,86
CM0835	130 x 130 x 21	1,50	6 / 5,00	10	724,65

Escuadra para muebles con extremidades redondas, zincado

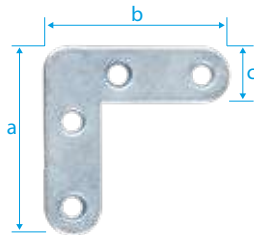

CÓDIGO CODE	MEDIDAS SIZE a x b x c		Nº AGUJEROS Nº HOLES		€ / 100
CM0845	40 x 40 x 12	1,75	4 / 5,30	100	45,78

Escuadra de silla reforzada, zincada

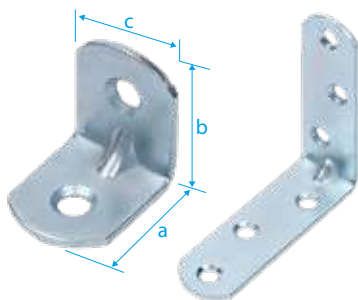

CÓDIGO CODE	MEDIDAS SIZE a x b x c		Nº AGUJEROS Nº HOLES		€ / 100
CM0860	20 x 20 x 16	1,75	2 / 4,50	120	29,03
CM0865	30 x 30 x 16	1,75	4 / 4,20	120	46,23
CM0870	40 x 40 x 19	1,75	4 / 4,70	120	70,81
CM0875	60 x 60 x 19	1,75	6 / 5,20	120	117,39
CM0880	80 x 80 x 19	1,75	6 / 5,50	50	158,63
CM0885	100 x 100 x 19	1,75	6 / 5,00	50	166,95

Pletina de ensamblaje, zincada

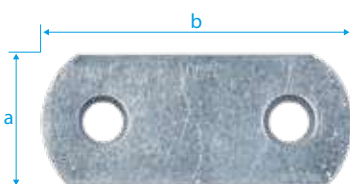

CÓDIGO CODE	MEDIDAS SIZE a x b x c		Nº AGUJEROS Nº HOLES		€ / 100
CM0900	16 x 40	1,50	2 / 4,50	100	46,02
CM0905	16 x 60	1,50	4 / 4,00	100	51,99
CM0910	19 x 80	2,00	4 / 4,50	100	76,57

EXPOSITOR LINEAL AUTOSERVICIO

OPTIMIZA EL ESPACIO Y MEJORA LA RENTABILIDAD DE SU ESTABLECIMIENTO

Los nuevos expositores lineales de MAREFIX le ofrecen una magnífica solución para aprovechar y organizar a la perfección el espacio de venta disponible en su comercio.



Nuestro sistema de bandejas facilita el orden y la reposición en el expositor autoservicio.





ACCESORIOS CERCADOS

TENALZ TENSOR DE ALAMBRE



ZINCADO

CÓDIGO CODE	MEDIDA SIZE		€/ 100
ACTENALZ	87,5 x 19,5	250	115,41

TENALV TENSOR DE ALAMBRE, COLOR VERDE, RAL-6005



ZINCADO + PINTADO EN VERDE

CÓDIGO CODE	MEDIDA SIZE		€/ 100
ACTENALV	87,5 x 19,5	250	171,09

TENTOZ TENSOR DE TORNILLO



ZINCADO

CÓDIGO CODE	MEDIDA SIZE		€/ 100
ACTENTOZ	Tornillo M-10	250	129,95

BPZ BRIDA POSTE



ZINCADO

CÓDIGO CODE	MEDIDA SIZE	MEDIDA / SIZE PULGADAS / INCH		€/ 100
ACBPZ33	Ø 33	1"	250	163,92
ACBPZ40	Ø 40		200	201,00
ACBPZ42	Ø 42	1 1/4"	200	217,28
ACBPZ48	Ø 48	1 1/2"	200	234,24
ACBPZ50	Ø 50		200	244,64
ACBPZ60	Ø 60	2"	150	260,92

BTENZ BRIDA TENSOR



ZINCADO

CÓDIGO CODE	MEDIDA SIZE	MEDIDA / SIZE PULGADAS / INCH		€/ 100
ACBTENZ	Ø 48	1 1/2"	200	395,39

ACCESORIOS CERCADOS

TAZ TAPÓN



ZINCADO

CÓDIGO CODE	MEDIDA SIZE	MEDIDA / SIZE PULGADAS / INCH		€ / 100
ACTAZ33	Ø 33	1"	500	81,62
ACTAZ40	Ø 40		350	86,82
ACTAZ42	Ø 42	1 1/4"	350	92,25
ACTAZ48	Ø 48	1 1/2"	300	97,67
ACTAZ50	Ø 50		250	124,30
ACTAZ60	Ø 60	2"	250	151,94

TAP TAPÓN POSTE



ZINCADO

CÓDIGO CODE	MEDIDA SIZE	MEDIDA / SIZE PULGADAS / INCH		€ / 100
ACTAP33	Ø 33	1"	100	217,51
ACTAP40	Ø 40		200	238,99
ACTAP42	Ø 42	1 1/4"	200	203,49
ACTAP48	Ø 48	1 1/2"	150	244,41

UÑA UÑAS CON AGUJERO



ZINCADO

CÓDIGO CODE	MEDIDA SIZE		€ / 100
ACUNAAG	Agujero / Hole Ø 6	1.500	24,36





CAJA CON VENTANA

MÁXIMA VISIBILIDAD Y COMODIDAD PARA QUE SUS CLIENTES ENCUENTREN DE INMEDIATO EL PRODUCTO QUE NECESITAN.

Nuestro sistema de bandejas facilita el orden y la reposición en el expositor autoservicio.



CAJA MASTER DE BRIDAS

CON SISTEMA DE DOBLE VENTANA. LA SOLUCIÓN MÁS RÁPIDA Y EFICAZ PARA VENDER Y REPONER LAS BOLSAS DE BRIDAS.





GEBFOR



BROCAS GEBFOR PRO

Características

• INSERTO DE CARBURO CON GEOMETRÍA MULTIÁNGULO

- 2 filos de corte
- Acabado arenado
- Para rotoperCUSión

Ventajas

- ✓ Metal de alta resistencia para mayor durabilidad
- ✓ Punta más ancha para mayor precisión
- ✓ **En taladros inalámbricos: aumenta la duración de la batería en un 20%.**



CÓDIGO CODE	Ø	Lu	Lt			€/1
PG101	3	20	60	1	10	2,52
PG102	4	35	75	1	10	2,52
PG104	5	45	85	1	10	2,52
PG106	6	60	100	1	10	3,04
PG620	6	160	200	1	10	8,24
PG640	6	360	400	1	10	10,50
PG108	7	60	100	1	10	3,04
PG109	8	80	120	1	10	3,30
PG820	8	160	200	1	10	9,11
PG840	8	360	400	1	10	12,06
PG111	9	80	120	1	10	4,60
PG112	10	80	120	1	10	4,60
PG1020	10	160	200	1	10	9,02
PG1040	10	360	400	1	10	14,23
PG113	11	110	150	1	10	6,51
PG114	12	110	150	1	10	6,51
PG1220	12	160	200	1	10	12,93
PG1240	12	360	400	1	10	17,61
PG115	13	110	150	1	5	9,28
PG116	14	110	150	1	5	9,28
PG1420	14	160	200	1	5	15,62
PG1440	14	360	400	1	5	18,66
PG117	15	110	150	1	5	15,36
PG118	16	110	150	1	5	16,23
PG1620	16	160	200	1	5	22,13
PG1640	16	360	400	1	5	26,21
PG119	18	120	160	1	5	21,61
PG1840	18	360	400	1	5	31,24
PG120	20	120	160	1	5	25,08
PG2040	20	360	400	1	5	39,92
PG121	22	120	160	1	5	33,84

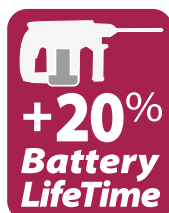

GEBFOR SDS PLUS



piedra stone hormigón concrete hormigón hueco concrete hollow ladrillo macizo solid brick semimacizo semi-solid brick ladrillo hueco hollow brick

BROCAS GEBFOR SDS PLUS

Características

- **NUEVA PUNTA DE CARBURO con 3 PUNTOS DE CONTACTO**

Concentra la fuerza de percusión en el eje de perforación

- **FILO CON PERFIL "Z"**

Alta precisión al inicio de la perforación
Efecto cincelado y mayor resistencia

- Compatible con conexión SDS-plus

Ventajas

- ✓ Mayor velocidad, potencia y precisión
- ✓ Rápida extracción de polvo
- ✓ Vida más larga



Compatible

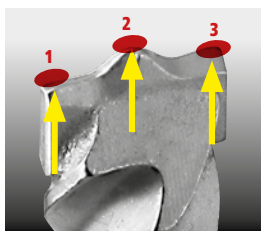

3 PUNTOS DE CONTACTO

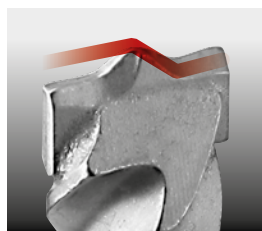

FILO DE CORTE CON PERFIL "Z"

CÓDIGO CODE	Ø	Lu	Lt			€/1
PS0411	4	50	110	1	5	8,58
PS0511	5	50	110	1	5	8,85
PS0516	5	100	160	1	5	8,85
PS0521	5	150	210	1	5	11,19
PS0611	6	50	110	1	5	7,46
PS0616	6	100	160	1	5	8,24
PS0621	6	150	210	1	5	11,19
PS0626	6	200	260	1	5	16,14
PS0631	6	250	310	1	5	17,70
PS6516	6,5	110	160	1	5	9,21
PS6521	6,5	150	210	1	5	11,54
PS6526	6,5	200	260	1	5	16,49
PS6531	6,5	250	310	1	5	52,11
PS0811	8	50	110	1	5	8,85
PS0816	8	100	160	1	5	8,68
PS0821	8	150	210	1	5	11,54
PS0846	8	400	460	1	5	24,38
PS0916	9	100	160	1	5	9,98
PS0921	9	150	210	1	5	12,67
PS1016	10	100	160	1	5	10,15
PS1021	10	150	210	1	5	11,80
PS1026	10	200	260	1	1	17,18
PS1031	10	250	310	1	1	18,40
PS1046	10	400	460	1	1	25,42
PS1061	10	550	610	1	1	40,35
PS1216	12	100	160	1	5	11,89
PS1221	12	150	210	1	5	14,49
PS1231	12	250	310	1	1	21,95
PS1246	12	400	460	1	1	28,37
PS1261	12	550	610	1	1	35,49
PS1416	14	100	160	1	5	14,66
PS1421	14	150	210	1	5	21,17
PS1431	14	250	310	1	1	24,90
PS1446	14	400	460	1	1	43,56
PS1461	14	550	610	1	1	47,29
PS1516	15	100	160	1	5	15,01
PS1521	15	150	210	1	5	26,12
PS1621	16	150	210	1	5	24,56
PS1631	16	250	310	1	1	30,63
PS1646	16	400	460	1	1	45,21
PS1661	16	550	610	1	1	64,73
PS1821	18	150	210	1	1	30,80
PS1846	18	400	460	1	1	45,90
PS2021	20	150	210	1	1	33,06
PS2046	20	400	460	1	1	53,02
PS2226	22	200	260	1	1	44,17
PS2246	22	400	460	1	1	63,78
PS2426	24	200	260	1	1	57,01
PS2446	24	400	460	1	1	80,44
PS2526	25	200	260	1	1	61,69
PS2546	25	400	460	1	1	91,20

GEBFOR TURBO 3



BROCA GEBFOR TURBO 3

Características

- **INSERTO DE CARBURO MONOBLOQUE CON PUNTA AUTOCENTRANTE**
- Ángulo de inclinación de 135°
- **3 filos de corte**
- Compatible con conexión SDS-plus

Ventajas

- ✓ Permite perforar hormigón y hormigón armado de forma óptima
- ✓ La punta autocentrante garantiza una mayor precisión
- ✓ El diseño de la punta asegura un orificio concéntrico
- ✓ Acelera la extracción de polvo
- ✓ Larga vida útil de la punta



Compatible

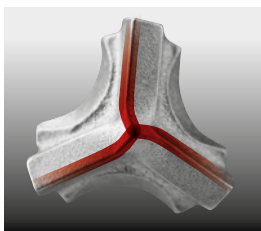

3 CORTADORES PARA UN TRABAJO PERFECTO

- ✓ Puede perforar barras de refuerzo
- ✓ Sin rotura del hormigón
- ✓ Orificio perfectamente calibrado y concéntrico

CÓDIGO CODE	Ø	Lu	Lt			€/1
PS3T0511	5	50	110	1	5	14,06
PS3T0516	5	100	160	1	5	14,14
PS3T0611	6	50	110	1	5	14,06
PS3T0616	6	100	160	1	5	14,14
PS3T0621	6	150	210	1	5	22,47
PS3T0811	8	50	110	1	5	15,27
PS3T0816	8	100	160	1	5	15,88
PS3T0821	8	150	210	1	5	19,78
PS3T0826	8	200	260	1	5	28,11
PS3T0831	8	250	310	1	5	32,11
PS3T1011	10	50	110	1	5	16,23
PS3T1016	10	100	160	1	5	16,92
PS3T1021	10	150	210	1	5	23,52
PS3T1026	10	200	260	1	5	31,32
PS3T1031	10	250	310	1	5	34,62
PS3T1046	10	400	460	1	5	38,87
PS3T1216	12	100	160	1	5	19,00
PS3T1226	12	200	260	1	5	34,88
PS3T1231	12	250	310	1	5	36,96
PS3T1246	12	400	460	1	5	38,96
PS3T1416	14	100	160	1	5	23,86
PS3T1421	14	150	210	1	5	33,58
PS3T1431	14	250	310	1	5	46,34
PS3T1446	14	400	460	1	1	45,73
PS3T1621	16	150	210	1	1	43,13
PS3T1631	16	250	310	1	1	48,77
PS3T1646	16	400	460	1	1	65,95
PS3T1821	18	150	210	1	1	52,41
PS3T1831	18	250	310	1	1	66,47
PS3T1846	18	400	460	1	1	81,13
PS3T2021	20	150	210	1	1	62,91
PS3T2046	20	400	460	1	1	102,04





CAJA CON VENTANA

SITA TTS



ZINCADO

CÓDIGO CODE	MEDIDA SIZE				€/ 1
VAMN06045	M-6x45	25	8	200	9,37
VAMN06060	M-6x60	20	8	160	9,50
VAMN06080	M-6x80	15	8	120	7,75
VAMN08050	M-8x50	20	8	160	11,05
VAMN08075	M-8x75	12	8	96	7,94
VAMN08090	M-8x90	12	8	96	8,59
VAMN08115	M-8x115	10	8	80	8,42
VAMN10070	M-10x70	6	8	48	5,40
VAMN10080	M-10x80	6	8	48	7,73
VAMN10090	M-10x90	6	8	48	6,00
VAMN10120	M-10x120	6	8	48	7,11
VAMN12090	M-12x90	6	8	48	8,61
VAMN12100	M-12x100	6	8	48	8,63
VAMN12110	M-12x110	6	8	48	9,10
VAMN12120	M-12x120	6	8	48	9,60

SITA TTSI



INOX (A2)

INOXIDABLE A2

CÓDIGO CODE	MEDIDA SIZE				€/ 1
VAMA206060	M-6x60	20	8	160	31,72
VAMA208075	M-8x75	12	8	96	31,06
VAMA208090	M-8x90	12	8	96	33,77
VAMA210070	M-10x70	10	8	80	34,89
VAMA210090	M-10x90	6	8	48	26,97
VAMA210120	M-10x120	6	8	48	33,98
VAMA212110	M-12x110	6	8	48	42,58

AC-TO



ZINCADO

CÓDIGO CODE	MEDIDA SIZE				€/ 1
VACTO08C	M-6x45 Ø 8	15	8	120	6,32
VACTO08L	M-6x60 Ø 8	15	8	120	7,11
VACTO10C	M-8x60 Ø 10	10	8	80	6,68
VACTO10L	M-8x80 Ø 10	10	8	80	7,89
VACTO12C	M-10x70 Ø 12	8	8	64	8,60
VACTO12L	M-10x100 Ø 12	6	8	48	7,98
VACTO16C	M-12x80 Ø 16	4	8	32	8,04

AC-TO-A2



INOX (A2)

INOXIDABLE A2

CÓDIGO CODE	MEDIDA SIZE				€/ 1
VACTO208C	M-6x45 Ø 8	15	8	120	20,38
VACTO208L	M-6x60 Ø 8	15	8	120	23,30
VACTO210C	M-8x60 Ø 10	10	8	80	23,19
VACTO210L	M-8x80 Ø 10	10	8	80	27,23
VACTO212C	M-10x70 Ø 12	8	8	64	31,15
VACTO212L	M-10x100 Ø 12	6	8	48	29,47

AC-AR



ZINCADO

CÓDIGO CODE	MEDIDA SIZE				€/ 1
VACAR08C	M-6x45 Ø 8	10	8	80	7,13
VACAR10C	M-8x60 Ø 10	6	8	48	7,43

AC-GA



ZINCADO

CÓDIGO CODE	MEDIDA SIZE				€/ 1
VACGA08C	M-6x45 Ø 8	10	8	80	7,41
VACGA10C	M-8x60 Ø 10	6	8	48	7,08

CAJA CON VENTANA

BETA, TTB



ZINCADO

CÓDIGO CODE	MEDIDA SIZE				€/ 1
VAHNM06	M-6x45 Ø 8	25	8	200	6,53
VAHNM08	M-8x30 Ø 10	20	8	160	6,47

OMEGA TLAT



ZINCADO

CÓDIGO CODE	MEDIDA SIZE				€/ 1
VTLATM06	M-6x23 Ø 8	50	8	400	18,15
VTLATM08	M-8x28 Ø 10	25	8	200	17,35
VTLATM10	M-10x33 Ø 12	15	8	120	14,79

MRR



ZINCADO

CÓDIGO CODE	MEDIDA SIZE				€/ 1
VMRRZ0420	M-4x20 Ø 7	50	8	400	12,11
VMRRZ0630	M-6x30 Ø 10	25	8	200	8,28
VMRRZ0830	M-8x30 Ø 11	20	8	160	7,25
VMRRZ1030	M-10x30 Ø 13	15	8	120	5,81

MRH



ZINCADO

CÓDIGO CODE	MEDIDA SIZE				€/ 1
VMRHZ0630	M-6x30 HEX. 10	20	8	160	7,21
VMRHZ0825	M-8x25 HEX. 11	20	8	160	5,81
VMRHZ1030	M-10x30 HEX. 13	15	8	120	6,09

LASTRO, TCR



ZINCADO

CÓDIGO CODE	MEDIDA SIZE				€/ 1
VHWACO435	M-4x35 Ø 8	25	8	200	9,76
VHWACO440	M-4x40 Ø 8	15	8	120	6,09
VHWACO446	M-4x46 Ø 8	15	8	120	6,64
VHWACO537	M-5x37 Ø 10	15	8	120	7,79
VHWACO550	M-5x50 Ø 10	15	8	120	9,21
VHWACO563	M-5x63 Ø 10	12	8	96	9,20
VHWACO637	M-6x37 Ø 12	10	8	80	5,88
VHWACO650	M-6x50 Ø 12	10	8	80	6,85

RAPID RN



NYLON

CÓDIGO CODE	MEDIDA SIZE				€/ 1
VHRN01	16x38	50	8	400	9,95

RAPID RA-V

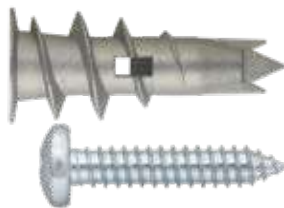

POLIAMIDA 6.6

CÓDIGO CODE	MEDIDA SIZE				€/ 1
VTGX0525	5x25	100	8	800	3,76
VTGX0630	6x30	100	8	800	4,43
VTGX0840	8x40	100	4	400	8,16
VTGX0850	8x50	100	4	400	12,14
VTGX1050	10x50	50	4	200	11,07
VTGX1260	12x60	25	4	100	23,09
VTGX1470	14x70	20	4	80	31,77

CÓDIGO CODE	MEDIDA SIZE				€/ 1
V90002	13x31	50	8	400	17,90

CAJA CON VENTANA

GL + DIN 571



CÓDIGO CODE	MEDIDA SIZE				€/ 1
VTGX57108	8x40 + 6x60	25	8	200	6,83
VTGX57110	10x50 + 7x70	15	8	120	7,06
VTGX57112	12x60 + 7x70	10	8	80	6,78

GL + TPOB



CÓDIGO CODE	MEDIDA SIZE				€/ 1
VTGXTPO05	5x25 + 4x30	50	8	400	4,86
VTGXTPO06	6x30 + 4,5x40	30	8	240	5,06
VTGXTPO08	8x40 + 5x60	20	8	160	5,32

GX-L



CÓDIGO CODE	MEDIDA SIZE				€/ 1
VTGXA08080	8x80	8	8	64	6,34
VTGXA08100	8x100	8	8	64	7,93
VTGXA10080	10x80	8	8	64	10,55
VTGXA10100	10x100	8	8	64	11,92
VTGXH08080	8x80	8	8	64	7,52
VTGXH08100	8x100	8	8	64	9,60
VTGXH10080	10x80	8	8	64	11,55
VTGXH10100	10x100	8	8	64	13,39

TACO NUDO



CÓDIGO CODE	MEDIDA SIZE				€/ 1
* VTANUDO06	6x35	80	8	640	5,33
* VTANUDO08	8x50	40	8	320	5,21
* VTANUDO10	10x60	20	8	160	5,12

POLIAMIDA 6.6

(*) HASTA FINAL DE EXISTENCIAS

TURBO JET / SVI INOX A2

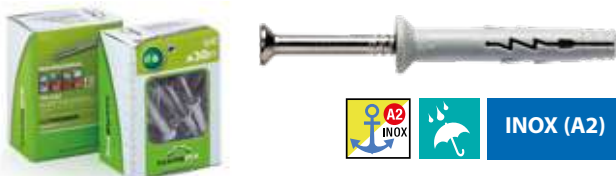

CÓDIGO CODE	MEDIDA SIZE				€/ 1
VTHTTSI21	5x27	30	8	240	8,17
VTHTTSI23	6x40	30	8	240	10,25
VTHTTSI24	6x67	25	8	200	12,34
VTHTTSI25	8x60	20	8	160	19,33

TURBO JET / SV



CÓDIGO CODE	MEDIDA SIZE				€/ 1
VT93025	5x27	40	8	320	4,32
VT93026	5x37	30	8	240	3,24
VT93027	5x47	30	8	240	3,58
VT93028	6x32	30	8	240	4,04
VT93029	6x40	30	8	240	3,82
VT93030	6x55	30	8	240	3,92
VT93031	6x67	25	8	200	4,40
VT93032	6x80	25	8	200	4,83
VT93033	8x45	25	8	200	5,43
VT93034	8x60	20	8	160	5,66
VT93035	8x75	20	8	160	6,82

CABEZA PLANA

CAJA CON VENTANA

TBE DIN-7504-K



ZINCADO

CÓDIGO CODE	MEDIDA SIZE				€/ 1
VTBEZ3509	3,5x9,5	250	8	2.000	8,05
VTBEZ3513	3,5x13	200	8	1.600	6,50
VTBEZ4213	4,2x13	150	8	1.200	6,77
VTBEZ4216	4,2x16	150	8	1.200	7,16
VTBEZ4219	4,2x19	150	8	1.200	8,47
VTBEZ4225	4,2x25	75	8	600	4,78
VTBEZ4232	4,2x32	75	8	600	5,55
VTBEZ4813	4,8x13	150	8	1.200	8,72
VTBEZ4816	4,8x16	150	8	1.200	9,64
VTBEZ4819	4,8x19	150	8	1.200	10,49
VTBEZ4825	4,8x25	120	8	960	10,82
VTBEZ4832	4,8x32	100	8	800	9,79
VTBEZ4838	4,8x38	85	8	680	8,67
VTBEZ5519	5,5x19	125	8	1.000	11,14
VTBEZ5522	5,5x22	125	8	1.000	11,63
VTBEZ5525	5,5x25	125	8	1.000	12,91
VTBEZ5532	5,5x32	85	8	680	10,18
VTBEZ5538	5,5x38	80	8	640	10,66
VTBEZ5550	5,5x50	50	8	400	9,48
VTBEZ5563	5,5x63	40	8	320	7,81
VTBEZ6319	6,3x19	100	8	800	12,66
VTBEZ6325	6,3x25	90	8	720	12,99
VTBEZ6332	6,3x32	70	8	560	11,94
VTBEZ6338	6,3x38	60	8	480	11,02
VTBEZ6350	6,3x50	40	8	320	8,89
VTBEZ6363	6,3x63	25	8	200	7,91

TBR DIN-7504-N



ZINCADO

CÓDIGO CODE	MEDIDA SIZE				€/ 1
VTBRZ3509	3,5x9,5	400	8	3.200	8,81
VTBRZ3511	3,5x11	300	8	2.400	8,02
VTBRZ3513	3,5x13	250	8	2.000	7,06
VTBRZ3516	3,5x16	225	8	1.800	6,74
VTBRZ3519	3,5x19	225	8	1.800	7,12
VTBRZ3525	3,5x25	180	8	1.440	6,92
VTBRZ3913	3,9x13	250	8	2.000	7,70
VTBRZ3916	3,9x16	200	8	1.600	6,82
VTBRZ3919	3,9x19	200	8	1.600	7,59
VTBRZ3925	3,9x25	150	8	1.200	6,78
VTBRZ3932	3,9x32	100	8	800	10,89
VTBRZ4213	4,2x13	200	8	1.600	7,15
VTBRZ4216	4,2x16	200	8	1.600	7,64
VTBRZ4219	4,2x19	175	8	1.400	7,39
VTBRZ4222	4,2x22	175	8	1.400	7,96
VTBRZ4225	4,2x25	125	8	1.000	6,39
VTBRZ4232	4,2x32	90	8	720	5,72
VTBRZ4238	4,2x38	75	8	600	5,72
VTBRZ4250	4,2x50	50	8	400	4,93
VTBRZ4813	4,8x13	125	8	1.000	6,34
VTBRZ4816	4,8x16	125	8	1.000	6,73
VTBRZ4819	4,8x19	110	8	880	6,48
VTBRZ4822	4,8x22	90	8	720	6,09
VTBRZ4825	4,8x25	90	8	720	6,53
VTBRZ4832	4,8x32	75	8	600	6,34
VTBRZ4838	4,8x38	55	8	440	5,58
VTBRZ4845	4,8x45	50	8	400	5,63
VTBRZ4850	4,8x50	40	8	320	5,14
VTBRZ4860	4,8x60	40	8	320	6,24
VTBRZ4880	4,8x80	25	8	200	5,28
VTBRZ5532	5,5x32	50	8	400	5,66

TBE+ARNE DIN-7504-K



ZINCADO

CÓDIGO CODE	MEDIDA SIZE				€/ 1
VTBE144819	4,8x19 / P14	100	8	800	13,07
VTBE144825	4,8x25 / P14	80	8	640	11,50
VTBE164819	4,8x19 / P16	70	8	560	9,48
VTBE165522	5,5x22 / P16	70	8	560	10,46
VTBE165525	5,5x25 / P16	60	8	480	10,86
VTBE165532	5,5x32 / P16	50	8	400	9,47
VTBE165538	5,5x38 / P16	45	8	360	9,55
VTBE165550	5,5x50 / P16	35	8	280	8,40
VTBE166325	6,3x25 / P16	50	8	400	10,21
VTBE166332	6,3x32 / P16	50	8	400	13,28
VTBE166338	6,3x38 / P16	40	8	320	11,31

AR-NE



CÓDIGO CODE	MEDIDA SIZE				€/ 1
VTARNEZ14	Ø 14	100	8	800	5,16
VTARNEZ16	Ø 16	100	8	800	5,71
VTARNEZ18	Ø 18	100	8	800	7,51
VTARNEZ25	Ø 25	40	8	320	7,13

CAJA CON VENTANA

DIN-7981



ZINCADO

CÓDIGO CODE	MEDIDA SIZE				€/ 100
VTR81Z29006	2,9x6,5	500	8	4.000	9,58
VTR81Z29009	2,9x9,5	400	8	3.200	8,36
VTR81Z35006	3,5x6,5	350	8	2.800	7,95
VTR81Z35009	3,5x9,5	250	8	2.000	5,98
VTR81Z35013	3,5x13	200	8	1.600	5,62
VTR81Z35016	3,5x16	200	8	1.600	6,06
VTR81Z35019	3,5x19	200	8	1.600	6,71
VTR81Z35025	3,5x25	150	8	1.200	9,09
VTR81Z39009	3,9x9,5	250	8	2.000	7,10
VTR81Z39013	3,9x13	200	8	1.600	6,61
VTR81Z39016	3,9x16	200	8	1.600	7,28
VTR81Z39019	3,9x19	150	8	1.200	6,38
VTR81Z39022	3,9x22	150	8	1.200	4,98
VTR81Z39025	3,9x25	100	8	800	5,31
VTR81Z42009	4,2x9,5	200	8	1.600	7,12
VTR81Z42013	4,2x13	200	8	1.600	7,43
VTR81Z42016	4,2x16	200	8	1.600	8,80
VTR81Z42019	4,2x19	150	8	1.200	6,86
VTR81Z42022	4,2x22	100	8	800	5,67
VTR81Z42025	4,2x25	100	8	800	5,64
VTR81Z42032	4,2x32	100	8	800	6,59
VTR81Z42038	4,2x38	75	8	600	5,83
VTR81Z42050	4,2x50	50	8	400	5,01
VTR81Z48009	4,8x9,5	150	8	1.200	6,99
VTR81Z48013	4,8x13	150	8	1.200	7,49
VTR81Z48016	4,8x16	100	8	800	6,05
VTR81Z48019	4,8x19	100	8	800	6,33
VTR81Z48025	4,8x25	100	8	800	7,52
VTR81Z48032	4,8x32	80	8	640	8,24
VTR81Z48038	4,8x38	80	8	640	10,43
VTR81Z48045	4,8x45	50	8	400	8,24
VTR81Z48050	4,8x50	40	8	320	6,42
VTR81Z48060	4,8x60	40	8	320	8,09
VTR81Z48070	4,8x70	40	8	320	7,70
VTR81Z48080	4,8x80	25	8	200	6,04
VTR81Z55019	5,5x19	100	8	800	8,39
VTR81Z55025	5,5x25	90	8	720	9,16
VTR81Z55032	5,5x32	60	8	480	11,77
VTR81Z55038	5,5x38	50	8	400	10,07
VTR81Z55050	5,5x50	40	8	320	7,96

TBP DIN-7504-P



ZINCADO

CÓDIGO CODE	MEDIDA SIZE				€/ 100
VTBPZ3513	3,5x13	250	8	2.000	6,16
VTBPZ3516	3,5x16	225	8	1.800	6,10
VTBPZ3519	3,5x19	200	8	1.600	6,39
VTBPZ3525	3,5x25	180	8	1.440	6,58
VTBPZ3913	3,9x13	200	8	1.600	5,68
VTBPZ3916	3,9x16	200	8	1.600	6,32
VTBPZ3919	3,9x19	175	8	1.400	6,18
VTBPZ3925	3,9x25	150	8	1.200	6,15
VTBPZ3938	3,9x38	100	8	800	5,77
VTBPZ4213	4,2x13	175	8	1.400	5,78
VTBPZ4216	4,2x16	175	8	1.400	6,18
VTBPZ4219	4,2x19	175	8	1.400	6,68
VTBPZ4225	4,2x25	125	8	1.000	6,04
VTBPZ4232	4,2x32	90	8	720	5,11
VTBPZ4238	4,2x38	75	8	600	4,98
VTBPZ4816	4,8x16	125	8	1.000	6,03
VTBPZ4819	4,8x19	100	8	800	5,33
VTBPZ4825	4,8x25	90	8	720	5,14
VTBPZ4832	4,8x32	75	8	600	5,70
VTBPZ4838	4,8x38	75	8	600	6,62
VTBPZ4850	4,8x50	50	8	400	6,15
VTBPZ5532	5,5x32	50	8	400	5,13

TAU



ZINCADO

CÓDIGO CODE	MEDIDA SIZE				€/ 100
VTAU63019	6,3x19	80	8	640	9,94
VTAU63025	6,3x25	70	8	560	11,66
VTAU63032	6,3x32	50	8	400	9,33
VTAU63040	6,3x40	40	8	320	9,34
VTAU63050	6,3x50	30	8	240	8,08
VTAU63060	6,3x60	25	8	200	8,17
VTAU63080	6,3x80	15	8	120	6,29



CAJA CON VENTANA

TCR



BLANCO

CÓDIGO CODE	MEDIDA SIZE				€/ 1
VTCR42B	Ø 4,20	150	8	1.200	10,21
VTCR48B	Ø 4,80	100	8	800	7,77
VTCR55B	Ø 5,50	100	8	800	7,77

NEGRO

VTCR42N	Ø 4,20	150	8	1.200	10,21
VTCR48N	Ø 4,80	100	8	800	7,77
VTCR55N	Ø 5,50	100	8	800	7,77

TBA DIN-571



ZINCADO

CÓDIGO CODE	MEDIDA SIZE				€/ 1
VTBAZ05040	5x40	50	8	400	5,19
VTBAZ05050	5x50	50	8	400	6,12
VTBAZ06040	6x40	50	8	400	6,46
VTBAZ06050	6x50	40	8	320	6,07
VTBAZ06060	6x60	30	8	240	5,31
VTBAZ06070	6x70	25	8	200	5,69
VTBAZ06080	6x80	20	8	160	5,59
VTBAZ07050	7x50	25	8	200	5,80
VTBAZ07060	7x60	20	8	160	5,51
VTBAZ07070	7x70	20	8	160	5,99
VTBAZ07080	7x80	15	8	120	6,33
VTBAZ08040	8x40	20	8	160	4,74
VTBAZ08050	8x50	20	8	160	5,44
VTBAZ08060	8x60	20	8	160	6,21
VTBAZ08070	8x70	20	8	160	7,03
VTBAZ08080	8x80	15	8	120	5,92
VTBAZ08090	8x90	10	8	80	4,49
VTBAZ08100	8x100	10	8	80	5,86
VTBAZ10060	10x60	10	8	80	6,28
VTBAZ10070	10x70	10	8	80	6,08
VTBAZ10080	10x80	10	8	80	6,46
VTBAZ10090	10x90	10	8	80	7,47
VTBAZ10100	10x100	10	8	80	7,87

DIN-7982

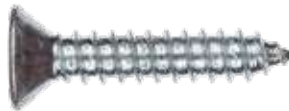

ZINCADO

CÓDIGO CODE	MEDIDA SIZE				€/ 1
VTR82Z29006	2,9x6,5	500	8	4.000	9,71
VTR82Z29009	2,9x9,5	400	8	3.200	8,88
VTR82Z29013	2,9x13	400	8	3.200	7,64
VTR82Z29016	2,9x16	300	8	2.400	6,86
VTR82Z35009	3,5x9,5	350	8	2.800	7,71
VTR82Z35013	3,5x13	250	8	2.000	6,40
VTR82Z35016	3,5x16	200	8	1.600	5,70
VTR82Z35019	3,5x19	200	8	1.600	5,97
VTR82Z35022	3,5x22	150	8	1.200	5,91
VTR82Z35025	3,5x25	100	8	800	4,05
VTR82Z35032	3,5x32	80	8	640	5,01
VTR82Z39016	3,9x16	200	8	1.600	6,29
VTR82Z39019	3,9x19	200	8	1.600	6,89
VTR82Z39022	3,9x22	150	8	1.200	5,93
VTR82Z39025	3,9x25	100	8	800	5,11
VTR82Z39032	3,9x32	80	8	640	5,77
VTR82Z42013	4,2x13	200	8	1.600	6,92
VTR82Z42016	4,2x16	200	8	1.600	6,78
VTR82Z42019	4,2x19	200	8	1.600	7,76
VTR82Z42025	4,2x25	100	8	800	5,16
VTR82Z42032	4,2x32	100	8	800	6,13
VTR82Z42038	4,2x38	80	8	640	6,55
VTR82Z48019	4,8x19	100	8	800	5,65
VTR82Z48025	4,8x25	100	8	800	7,02
VTR82Z48032	4,8x32	95	8	760	7,44
VTR82Z48038	4,8x38	80	8	640	7,69
VTR82Z55019	5,5x19	100	8	800	7,98
VTR82Z55025	5,5x25	80	8	640	7,82
VTR82Z55032	5,5x32	75	8	600	8,18
VTR82Z55038	5,5x38	60	8	480	8,51

TINV



ZINCADO

CÓDIGO CODE	MEDIDA SIZE				€/ 1
VTINVZ7060	7x60	15	8	120	6,22
VTINVZ7070	7x70	15	8	120	6,72
VTINVZ7080	7x80	10	8	80	6,01

ZINCADO NEGRO

VTINVN7060	7x60	15	8	120	9,91
VTINVN7070	7x70	15	8	120	10,47
VTINVN7080	7x80	10	8	80	8,01

CAJA CON VENTANA

TTXEB



BICROMATADO

CÓDIGO CODE	MEDIDA SIZE				€/ 1
VTTXEB30016	3x16	300	8	2.400	9,04
VTTXEB30020	3x20	250	8	2.000	8,31
VTTXEB30025	3x25	200	8	1.600	7,77
VTTXEB30030	3x30	170	8	1.360	7,42
VTTXEB30040	3x40	120	8	960	6,30
VTTXEB35016	3,5x16	250	8	2.000	8,36
VTTXEB35020	3,5x20	200	8	1.600	7,51
VTTXEB35025	3,5x25	170	8	1.360	7,66
VTTXEB35030	3,5x30	150	8	1.200	7,43
VTTXEB35035	3,5x35	100	8	800	5,91
VTTXEB35040	3,5x40	75	8	600	5,42
VTTXEB35050	3,5x50	75	8	600	6,23
VTTXEB40025	4x25	125	8	1.000	7,05
VTTXEB40030	4x30	125	8	1.000	8,06
VTTXEB40035	4x35	100	8	800	7,64
VTTXEB40040	4x40	100	8	800	6,92
VTTXEB40045	4x45	75	8	600	6,92
VTTXEB40050	4x50	75	8	600	7,82
VTTXEB40060	4x60	50	8	400	6,37
VTTXEB45030	4,5x30	150	8	1.200	10,00
VTTXEB45035	4,5x35	100	8	800	8,22
VTTXEB45040	4,5x40	75	8	600	7,13
VTTXEB45045	4,5x45	75	8	600	7,85
VTTXEB45050	4,5x50	50	8	400	6,08
VTTXEB45060	4,5x60	50	8	400	7,46
VTTXEB45070	4,5x70	50	8	400	8,18
VTTXEB50030	5,0x30	100	8	800	8,73
VTTXEB50035	5,0x35	90	8	720	8,24
VTTXEB50040	5,0x40	75	8	600	8,82
VTTXEB50050	5,0x50	50	8	400	7,25
VTTXEB50060	5,0x60	40	8	320	7,12
VTTXEB50070	5,0x70	25	8	200	5,64
VTTXEB50080	5,0x80	25	8	200	6,41
VTTXEB50090	5,0x90	25	8	200	6,75
VTTXEB60050	6,0x50	40	8	320	8,31
VTTXEB60060	6,0x60	30	8	240	7,84
VTTXEB60070	6,0x70	20	8	160	6,43
VTTXEB60080	6,0x80	20	8	160	6,94

TTXEZ



ZINCADO

CÓDIGO CODE	MEDIDA SIZE				€/ 1
VTTXEZ30016	3,0x16	300	8	2.400	9,04
VTTXEZ30020	3,0x20	250	8	2.000	8,31
VTTXEZ30025	3,0x25	200	8	1.600	7,77
VTTXEZ30030	3,0x30	170	8	1.360	7,42
VTTXEZ30040	3,0x40	120	8	960	6,30
VTTXEZ35016	3,5x16	250	8	2.000	8,36
VTTXEZ35020	3,5x20	200	8	1.600	7,51
VTTXEZ35025	3,5x25	170	8	1.360	7,66
VTTXEZ35030	3,5x30	150	8	1.200	7,43
VTTXEZ35035	3,5x35	100	8	800	5,91
VTTXEZ35040	3,5x40	75	8	600	5,42
VTTXEZ35050	3,5x50	75	8	600	6,23
VTTXEZ40025	4,0x25	125	8	1.000	7,05
VTTXEZ40030	4,0x30	125	8	1.000	8,06
VTTXEZ40035	4,0x35	100	8	800	7,64
VTTXEZ40040	4,0x40	100	8	800	6,92
VTTXEZ40045	4,0x45	75	8	600	6,92
VTTXEZ40050	4,0x50	75	8	600	7,82
VTTXEZ40060	4,0x60	50	8	400	6,37
VTTXEZ45030	4,5x30	150	8	1.200	10,00
VTTXEZ45035	4,5x35	100	8	800	8,22
VTTXEZ45040	4,5x40	75	8	600	7,13
VTTXEZ45045	4,5x45	75	8	600	7,85
VTTXEZ45050	4,5x50	50	8	400	6,08
VTTXEZ45060	4,5x60	50	8	400	7,46
VTTXEZ45070	4,5x70	50	8	400	8,18
VTTXEZ50030	5,0x30	100	8	800	8,73
VTTXEZ50035	5,0x35	90	8	720	8,24
VTTXEZ50040	5,0x40	75	8	600	8,82
VTTXEZ50050	5,0x50	50	8	400	7,25
VTTXEZ50060	5,0x60	40	8	320	7,12
VTTXEZ50070	5,0x70	25	8	200	5,64
VTTXEZ50080	5,0x80	25	8	200	6,41
VTTXEZ50090	5,0x90	25	8	200	6,75
VTTXEZ60050	6,0x50	40	8	320	8,31
VTTXEZ60060	6,0x60	30	8	240	7,84
VTTXEZ60070	6,0x70	20	8	160	6,43
VTTXEZ60080	6,0x80	20	8	160	6,94

TTXE-A2



INOX (A2)



INOXIDABLE A2

CÓDIGO CODE	MEDIDA SIZE				€/ 1
VTTXEI50050	5x50	50	8	400	19,24
VTTXEI50060	5x60	50	8	400	23,12
VTTXEI50070	5x70	50	8	400	26,22

CAJA CON VENTANA

TPOB



TPOZ



BICROMATADO

CÓDIGO CODE	MEDIDA SIZE				€/ 1
VTPOB30016	3x16	350	8	2.800	5,93
VTPOB30020	3x20	250	8	2.000	5,53
VTPOB30025	3x25	250	8	2.000	5,41
VTPOB30030	3x30	250	8	2.000	6,36
VTPOB30040	3x40	150	8	1.200	5,57
VTPOB35016	3,5x16	250	8	2.000	5,71
VTPOB35020	3,5x20	250	8	2.000	7,39
VTPOB35025	3,5x25	250	8	2.000	6,98
VTPOB35030	3,5x30	200	8	1.600	6,66
VTPOB35035	3,5x35	150	8	1.200	5,75
VTPOB35040	3,5x40	100	8	800	4,68
VTPOB35050	3,5x50	75	8	600	4,45
VTPOB40016	4x16	250	8	2.000	6,27
VTPOB40020	4x20	250	8	2.000	7,34
VTPOB40025	4x25	200	8	1.600	6,85
VTPOB40030	4x30	170	8	1.360	6,68
VTPOB40035	4x35	150	8	1.200	8,11
VTPOB40040	4x40	120	8	960	6,27
VTPOB40045	4x45	100	8	800	5,58
VTPOB40050	4x50	100	8	800	6,27
VTPOB40060	4x60	75	8	600	5,78
VTPOB45030	4,5x30	150	8	1.200	7,42
VTPOB45035	4,5x35	150	8	1.200	8,11
VTPOB45040	4,5x40	120	8	960	7,12
VTPOB45045	4,5x45	100	8	800	7,12
VTPOB45050	4,5x50	80	8	640	6,47
VTPOB45060	4,5x60	70	8	560	6,69
VTPOB45070	4,5x70	50	8	400	5,88
VTPOB50030	5x30	100	8	800	6,41
VTPOB50035	5x35	100	8	800	6,78
VTPOB50040	5x40	100	8	800	7,32
VTPOB50050	5x50	80	8	640	7,18
VTPOB50060	5x60	70	8	560	7,67
VTPOB50070	5x70	35	8	280	5,13
VTPOB50080	5x80	30	8	240	5,14
VTPOB50090	5x90	30	8	240	5,79
VTPOB50100	5x100	25	8	200	5,44
VTPOB60040	6x40	80	8	640	8,75
VTPOB60050	6x50	50	8	400	7,28
VTPOB60060	6x60	40	8	320	6,44
VTPOB60070	6x70	30	8	240	5,93
VTPOB60080	6x80	30	8	240	6,45
VTPOB60090	6x90	20	8	160	6,28
VTPOB60100	6x100	15	8	120	5,27

ZINCADO

CÓDIGO CODE	MEDIDA SIZE				€/ 1
VTPOZ30016	3x16	350	8	2.800	5,93
VTPOZ30020	3x20	250	8	2.000	5,53
VTPOZ30025	3x25	250	8	2.000	5,41
VTPOZ30030	3x30	250	8	2.000	6,36
VTPOZ30040	3x40	150	8	1.200	5,57
VTPOZ35016	3,5x16	250	8	2.000	5,71
VTPOZ35020	3,5x20	250	8	2.000	7,39
VTPOZ35025	3,5x25	250	8	2.000	6,98
VTPOZ35030	3,5x30	200	8	1.600	6,66
VTPOZ35035	3,5x35	150	8	1.200	5,75
VTPOZ35040	3,5x40	100	8	800	4,68
VTPOZ35050	3,5x50	75	8	600	4,45
VTPOZ40016	4x16	250	8	2.000	6,27
VTPOZ40020	4x20	250	8	2.000	7,34
VTPOZ40025	4x25	200	8	1.600	6,85
VTPOZ40030	4x30	170	8	1.360	6,68
VTPOZ40035	4x35	150	8	1.200	8,11
VTPOZ40040	4x40	120	8	960	6,27
VTPOZ40045	4x45	100	8	800	5,58
VTPOZ40050	4x50	100	8	800	6,27
VTPOZ40060	4x60	75	8	600	5,78
VTPOZ45030	4,5x30	150	8	1.200	7,42
VTPOZ45035	4,5x35	150	8	1.200	8,11
VTPOZ45040	4,5x40	120	8	960	7,12
VTPOZ45045	4,5x45	100	8	800	7,12
VTPOZ45050	4,5x50	80	8	640	6,47
VTPOZ45060	4,5x60	70	8	560	6,69
VTPOZ45070	4,5x70	50	8	400	5,88
VTPOZ50030	5x30	100	8	800	6,41
VTPOZ50035	5x35	100	8	800	6,78
VTPOZ50040	5x40	100	8	800	7,32
VTPOZ50050	5x50	80	8	640	7,18
VTPOZ50060	5x60	70	8	560	7,67
VTPOZ50070	5x70	35	8	280	5,13
VTPOZ50080	5x80	30	8	240	5,14
VTPOZ50090	5x90	30	8	240	5,79
VTPOZ50100	5x100	25	8	200	5,44
VTPOZ60040	6x40	80	8	640	8,75
VTPOZ60050	6x50	50	8	400	7,28
VTPOZ60060	6x60	40	8	320	6,44
VTPOZ60070	6x70	30	8	240	5,93
VTPOZ60080	6x80	30	8	240	6,45
VTPOZ60090	6x90	20	8	160	6,28
VTPOZ60100	6x100	15	8	120	5,27

TPL



FOSFATADO

CÓDIGO CODE	MEDIDA SIZE				€/ 1
VTPLN35025	3,5x25	250	8	2.000	8,73
VTPLN35035	3,5x35	200	8	1.600	9,45
VTPLN35045	3,5x45	120	8	960	7,07

CAJA CON VENTANA

TTOB



BICROMATADO

CÓDIGO CODE	MEDIDA SIZE				€/ 1
VTTOB30025	3,0x25	200	8	1.600	5,57
VTTOB30030	3,0x30	200	8	1.600	6,71
VTTOB35016	3,5x16	200	8	1.600	5,05
VTTOB35020	3,5x20	200	8	1.600	6,10
VTTOB35025	3,5x25	200	8	1.600	6,71
VTTOB35030	3,5x30	200	8	1.600	7,85
VTTOB35040	3,5x40	200	8	1.600	6,51
VTTOB35050	3,5x50	200	8	1.600	6,20
VTTOB40020	4,0x20	250	8	2.000	8,20
VTTOB40025	4,0x25	200	8	1.600	9,49
VTTOB40030	4,0x30	170	8	1.360	7,94
VTTOB40035	4,0x35	150	8	1.200	7,76
VTTOB40040	4,0x40	120	8	960	8,39
VTTOB40045	4,0x45	100	8	800	9,43
VTTOB40050	4,0x50	100	8	800	7,20
VTTOB40060	4,0x60	75	8	600	7,55
VTTOB45030	4,5x30	150	8	1.200	8,07
VTTOB45035	4,5x35	150	8	1.200	8,89
VTTOB45040	4,5x40	120	8	960	10,29
VTTOB45045	4,5x45	100	8	800	7,23
VTTOB45050	4,5x50	80	8	640	9,01
VTTOB45060	4,5x60	70	8	560	8,28
VTTOB45070	4,5x70	50	8	400	7,30
VTTOB50030	5,0x30	100	8	800	7,07
VTTOB50035	5,0x35	100	8	800	7,69
VTTOB50040	5,0x40	100	8	800	9,30
VTTOB50050	5,0x50	80	8	640	10,51
VTTOB50060	5,0x60	70	8	560	9,62
VTTOB50070	5,0x70	35	8	280	5,47
VTTOB50080	5,0x80	30	8	240	5,43
VTTOB50090	5,0x90	30	8	240	5,93
VTTOB50100	5,0x100	25	8	200	6,11
VTTOB60060	6,0x60	40	8	320	10,06
VTTOB60070	6,0x70	30	8	240	6,01
VTTOB60080	6,0x80	30	8	240	7,42
VTTOB60090	6,0x90	20	8	160	7,50
VTTOB60100	6,0x100	15	8	120	7,64

REM-FL



ZINCADO

CÓDIGO CODE	MEDIDA SIZE				€/ 1
VREMFL4835	4,8x35	25	8	200	9,42

REM-NO



ZINCADO

CÓDIGO CODE	MEDIDA SIZE				€/ 1
VREMNO3206	3,2x6	50	8	400	2,71
VREMNO3208	3,2x8	50	8	400	2,71
VREMNO3210	3,2x10	50	8	400	2,92
VREMNO3212	3,2x12	50	8	400	3,30
VREMNO3214	3,2x14	50	8	400	3,41
VREMNO3216	3,2x16	50	8	400	4,12
VREMNO3218	3,2x18	50	8	400	4,32
VREMNO4006	4,0x6	50	8	400	3,12
VREMNO4008	4,0x8	50	8	400	3,08
VREMNO4010	4,0x10	50	8	400	3,41
VREMNO4012	4,0x12	50	8	400	3,72
VREMNO4014	4,0x14	50	8	400	4,20
VREMNO4016	4,0x16	50	8	400	4,39
VREMNO4018	4,0x18	50	8	400	4,69
VREMNO4020	4,0x20	50	8	400	4,85
VREMNO4808	4,8x8	50	8	400	4,32
VREMNO4810	4,8x10	50	8	400	4,46
VREMNO4812	4,8x12	50	8	400	4,69
VREMNO4814	4,8x14	50	8	400	5,36
VREMNO4816	4,8x16	50	8	400	5,83
VREMNO4818	4,8x18	50	8	400	6,65
VREMNO4820	4,8x20	50	8	400	7,17
VREMNO4822	4,8x22	25	8	200	3,94
VREMNO4825	4,8x25	25	8	200	4,00
VREMNO4830	4,8x30	25	8	200	4,82
VREMNO4835	4,8x35	25	8	200	5,30

REM-CA



ZINCADO

CÓDIGO CODE	MEDIDA SIZE				€/ 1
VREMCA4010	4,0x10 Ø12	50	8	400	4,77
VREMCA4012	4,0x12 Ø12	35	8	280	4,05
VREMCA4016	4,0x16 Ø12	35	8	280	4,55
VREMCA4810	4,8x10 Ø14	25	8	200	3,72
VREMCA4812	4,8x12 Ø14	25	8	200	3,74
VREMCA4814	4,8x14 Ø14	25	8	200	4,26
VREMCA4816	4,8x16 Ø14	25	8	200	4,44
VREMCA4818	4,8x18 Ø14	20	8	160	3,87

CAJA CON VENTANA

BCA



ZINCADO

CÓDIGO CODE	MEDIDA SIZE				€/ 1
VBCAM04	M-04	20	8	160	8,37
VBCAM05	M-05	20	8	160	9,34
VBCAM06	M-06	15	8	120	8,06

PACA



ZINCADO

CÓDIGO CODE	MEDIDA SIZE				€/ 1
VPACA04	M-04	24	8	192	6,48
VPACA05	M-05	20	8	160	6,39
VPACA06	M-06	15	8	120	5,86

BES



ZINCADO

CÓDIGO CODE	MEDIDA SIZE				€/ 1
VBESM04	M-04x100	6	8	48	5,42
VBESM05	M-05x100	6	8	48	5,58
VBESM06	M-06x100	4	8	32	5,08

PAES



ZINCADO

CÓDIGO CODE	MEDIDA SIZE				€/ 1
VPAES04	M-04x75	6	8	48	4,35
VPAES05	M-05x95	6	8	48	4,99
VPAES06	M-06x100	4	8	32	4,59

BGA



ZINCADO

CÓDIGO CODE	MEDIDA SIZE				€/ 1
VBGAM04	M-04x75	6	8	48	5,45
VBGAM05	M-05x80	6	8	48	5,87
VBGAM06	M-06x85	4	8	32	4,97

PAGA



ZINCADO

CÓDIGO CODE	MEDIDA SIZE				€/ 1
VPAGA04	M-04x75	6	8	48	4,30
VPAGA05	M-05x95	6	8	48	4,99
VPAGA06	M-06x100	4	8	32	4,59

CAJA CON VENTANA

HA



HC



ZINCADO

CÓDIGO CODE	MEDIDA SIZE				€/ 1
VHA14025	14x25	125	8	1.000	5,67
VHA16030	16x30	75	8	600	3,87
VHA17040	17x40	75	8	600	5,43
VHA18040	18x40	75	8	600	6,10
VHA18050	18x50	90	8	720	7,99
VHA19050	19x50	60	8	480	6,92
VHA19060	19x60	60	8	480	7,44
VHA19070	19x70	60	8	480	8,34
VHA20050	20x50	60	8	480	8,47
VHA20060	20x60	60	8	480	9,11
VHA20070	20x70	60	8	480	9,77
VHA20080	20x80	60	8	480	10,93
VHA21070	21x70	70	8	560	14,00
VHA21080	21x80	70	8	560	15,39
VHA21090	21x90	70	8	560	17,04
VHA21100	21x100	35	8	280	12,57
VHA22110	22x110	35	8	280	13,97
VHA22120	22x120	20	8	160	19,00
VHA23130	23x130	20	8	160	29,06

ZINCADO

CÓDIGO CODE	MEDIDA SIZE				€/ 1
VHC14025	14x25	125	8	1.000	5,67
VHC16030	16x30	75	8	600	3,87
VHC17040	17x40	75	8	600	5,43
VHC18040	18x40	75	8	600	6,10
VHC18050	18x50	90	8	720	7,99
VHC19050	19x50	60	8	480	6,92
VHC19060	19x60	60	8	480	7,44
VHC19070	19x70	60	8	480	8,34
VHC20050	20x50	60	8	480	8,46
VHC20060	20x60	60	8	480	9,11
VHC20070	20x70	60	8	480	9,77
VHC20080	20x80	60	8	480	10,93
VHC21070	21x70	70	8	560	14,00
VHC21080	21x80	70	8	560	15,39
VHC21090	21x90	70	8	560	17,04
VHC21100	21x100	35	8	280	12,57
VHC22110	22x110	35	8	280	13,97
VHC22120	22x120	20	8	160	19,00
VHC23130	23x130	20	8	160	29,06

AR



ZINCADO

CÓDIGO CODE	MEDIDA SIZE				€/ 1
VAR14025	14x25	125	8	1.000	5,67
VAR16030	16x30	75	8	600	3,87
VAR17040	17x40	75	8	600	5,43
VAR18040	18x40	75	8	600	6,10
VAR18050	18x50	90	8	720	7,99
VAR19050	19x50	60	8	480	6,92
VAR19060	19x60	60	8	480	7,44
VAR19070	19x70	60	8	480	8,34
VAR20060	20x60	60	8	480	9,11
VAR20070	20x70	60	8	480	9,77
VAR20080	20x80	60	8	480	10,93
VAR21080	21x80	60	8	480	15,39
VAR21090	21x90	70	8	560	17,04
VAR22100	22x100	35	8	280	12,57
VAR22110	22x110	35	8	280	13,97
VAR22120	22x120	20	8	160	19,00
VAR23130	23x130	20	8	160	29,06

BOLSAS

BRB



BLANCA

CÓDIGO CODE	MEDIDA SIZE			€/ 1
VBRB25080	2,5x80	100	3.000	46,26
VBRB25100	2,5x100	100	3.000	53,09
VBRB25140	2,5x140	100	3.000	78,55
VBRB25160	2,5x160	100	2.000	58,16
VBRB25200	2,5x200	100	2.000	75,76
VBRB36140	3,6x140	100	2.000	72,45
VBRB36200	3,6x200	100	2.000	98,73
VBRB36300	3,6x300	100	1.000	80,21
VBRB36370	3,6x370	100	1.000	108,67
VBRB48120	4,8x120	100	2.000	105,77
VBRB48160	4,8x160	100	2.000	117,57
VBRB48180	4,8x180	100	2.000	125,44
VBRB48200	4,8x200	100	2.000	128,34
VBRB48250	4,8x250	100	2.000	185,26
VBRB48290	4,8x290	100	1.000	100,29
VBRB48370	4,8x370	100	1.000	129,27
VBRB76200	7,6x200	100	1.000	152,55
VBRB76290	7,6x290	100	1.000	191,99
VBRB76370	7,6x370	100	800	199,46
VBRB12225	12,5x225	100	400	217,55

BRN



NEGRA

CÓDIGO CODE	MEDIDA SIZE			€/ 1
VBRN25080	2,5x80	100	3.000	46,26
VBRN25100	2,5x100	100	3.000	53,09
VBRN25140	2,5x140	100	3.000	78,55
VBRN25160	2,5x160	100	2.000	58,16
VBRN25200	2,5x200	100	2.000	75,76
VBRN36140	3,6x140	100	2.000	72,45
VBRN36200	3,6x200	100	2.000	98,73
VBRN36300	3,6x300	100	1.000	80,21
VBRN36370	3,6x370	100	1.000	108,67
VBRN48120	4,8x120	100	2.000	105,77
VBRN48160	4,8x160	100	2.000	117,57
VBRN48180	4,8x180	100	2.000	125,44
VBRN48200	4,8x200	100	2.000	128,34
VBRN48250	4,8x250	100	2.000	185,26
VBRN48290	4,8x290	100	1.000	100,29
VBRN48370	4,8x370	100	1.000	129,27
VBRN76200	7,6x200	100	1.000	152,55
VBRN76290	7,6x290	100	1.000	191,99
VBRN76370	7,6x370	100	800	199,46
VBRN12225	12,5x225	100	400	217,55

BRV



VERDE

CÓDIGO CODE	MEDIDA SIZE			€/ 1
VBRV25100	2,5x100	100	3.000	54,33
VBRV36140	3,6x140	100	2.000	92,11
VBRV36200	3,6x200	100	2.000	117,99
VBRV48200	4,8x200	100	2.000	161,46
VBRV48290	4,8x290	100	1.000	120,57

BR-TACO



BLANCO

CÓDIGO CODE	MEDIDA SIZE			€/ 1
VTABRIBL06	Ø 6	100	1.000	68,82
VTABRIBL08	Ø 8	100	1.000	63,13



NEGRO

CÓDIGO CODE	MEDIDA SIZE			€/ 1
VTABRINE06	Ø 6	100	1.000	67,27
VTABRINE08	Ø 8	100	1.000	63,13

EXPOSITORES DE PUNTO DE VENTA

EXPOSITOR METÁLICO

color gris antracita

CÓDIGO CODE	DESCR.	MEDIDA SIZE
ESELF05	3 estantes + ganchos	100x40x240 (H)
ESELF24	4 estantes	100x40x240 (H)



ESELF24

ESELF05

EXPOSITOR DE POLIPROPILENO

color negro

CÓDIGO CODE	DESCR.	MEDIDA SIZE
ESELF20	PARA ANCLAJES QUÍMICOS	54x46x156 (H)
ESELF09	EXPOSITOR UNIVERSAL	54x46x156 (H)
ESELF11	PARA LÍNEA GEBOSIL	54x46x156 (H)
ESELF21	PARA TORNILLOS GETOWOOD	54x46x156 (H)



ESELF20

ESELF09

ESELF11

ESELF21

EXPOSITORES DE PUNTO DE VENTA

DISPLAY MOSTRADOR DE CARTÓN



ESELF34



ESELF35

ART.	CÓDIGO CODE	DESCR.	CAJA	CANTIDAD CAJA
* ESELF34	18125	BI-FIX Ø6x35 + Tornillo TPS	6	100
	18130	BI-FIX Ø8x45 + Tornillo TPS	6	50
	5307	Blister BI-FIX Ø6x35 + Tornillo TPS	5	50
* ESELF35	5308	Blister BI-FIX Ø8x45 + Tornillo TPS	4	25
	18125	BI-FIX Ø6x35 + Tornillo TPS	12	100
	18130	BI-FIX Ø8x45 + Tornillo TPS	6	50

(*) HASTA FINAL DE EXISTENCIAS



ESELF31



ESELF32

ART.	CÓDIGO CODE	DESCR.	CAJA	CANTIDAD CAJA
ESELF31	05293	Blister GL Ø6x45 + Tornillo TPS	22	30
	05294	Blister GL Ø8x50 + Tornillo TPS	11	20
ESELF32	65119	GL Ø6x45 + Tornillo TPS	6	100
	65120	GL Ø8x50 + Tornillo TPS	3	50

DISPLAY MOSTRADOR DE METAL

color negro



ESELF23

CÓDIGO CODE	DESCR.	MEDIDA SIZE
* ESELF33	BROCAS GEBFOR (14 ganchos incluidos)	33x24x43 (H)

(*) HASTA FINAL DE EXISTENCIAS

GEBOFOAM MULTI 360°
CS15
Para aplicaciones en todas las posiciones.
Válvula especial de 360°



GEBOFOAM TETTI
CS04 - CS08
Para instalación y adhesión de azulejos y tejas.
Alto rendimiento

GEBOFOAM BLU
CS22
Para instalación y adhesión impermeable.



GEBOFOAM ELASTIC
CS16
Ideal para instalar cerramientos.
Alto aislamiento termo acústico



GEBOFOAM BUILD ISOLAMENTI
CS14 - CS17
Para instalación y adhesión de sistemas de aislamiento exterior y paneles de cartón-yeso.
alto aislamiento



GEBOFOAM B1
CS21 - CS03
Para aplicaciones resistentes al fuego "B1"

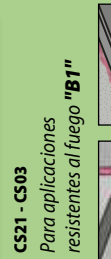

GEBOFOAM NORDIC
CS07 - CS06
Para aplicaciones a bajas temperaturas.

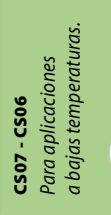

GEBOFOAM S750-P750
CS02 - CS01
Uso universal.

Condiciones Generales de Venta, MAREFIX, S.L.U.

PORTES

- Los portes serán pagados a partir de **300** euros netos para los envíos a la Península y Baleares. Nos reservamos el derecho a remitir las mercancías por nuestra agencia de transportes.
- Si el pedido no llega a portes pagados y si no hay contraorden por su parte, se lo enviaremos igualmente a portes pagados, cobrando **9,80** euros en Factura por este concepto. A Baleares, cobraremos por este concepto **25,00** euros.
- Por favor, rogamos procedan a verificar el estado del envío a su recepción y formulen ante el transportista las reservas que en su caso procedan, comunicándonos las posibles anomalías de inmediato.
- La recepción de la mercancía, supone la aceptación de las condiciones generales de venta de MAREFIX, S.L.U.
- Por cuestiones derivadas de costos, no se podrán servir pedidos inferiores a **100** euros, pero en el caso de tener que servirlos, se cargarán **10** euros en concepto de gestión.

CONDICIONES DE PAGO

- Giro bancario domiciliado a 60 días MÁXIMO.
- Los documentos de pago físicos, deberán ser remitidos en un plazo máximo de 30 días posteriores a la fecha de la factura.
- Los documentos de pago que no respeten los vencimientos reflejados en nuestra factura, ocasionarán un cargo por aplazamiento del 1% mensual.
- Nuestro sistema informático procederá a la retención automática de los pedidos si se produjese algún impago o demora en la recepción de documentos de pago.

PLAZO DE ENTREGA

- Salvo acuerdo expreso por nuestra Central de Logroño, los plazos de entrega indicados por nuestros Agentes Comerciales son a título orientativo.
- El retraso de los plazos de entrega o fechas previstas no dará lugar a penalización.

AGOSTO Y DICIEMBRE

- Los vencimientos que se atiendan en estos meses, no tendrán cargos ni abonos.
- Si el vencimiento se fracciona al 50% entre el mes anterior y posterior, no se aplicarán cargos ni abonos.
- Si el vencimiento se adelanta al mes anterior, se abonará en factura un 1% de descuento en concepto de pago adelantado.
- Si el vencimiento se aplaza al mes siguiente, se cargará en factura un 1% en concepto de gastos financieros.

DEVOLUCION DE MATERIAL

- No se admitirán devoluciones de material transcurridos 15 días desde la fecha de entrega.
- Si la devolución se produjese por motivos no imputables a MAREFIX, S.L.U., el cliente la enviará a portes pagados.
- Adicionalmente se le cargará el coste que se origine en concepto de reempaquetado, así como los del transporte del envío inicial. En total el recargo supondrá un 20% aproximado del valor de la mercancía. El importe de la mercancía devuelta o abono, será descontado de la factura inicial y se le notificará al cliente.
- No se admitirán devoluciones de material a portes debidos, si no vienen por nuestras agencias habituales de transporte.

Para cualquier cuestión derivada de la venta efectuada por MAREFIX, S.L.U., serán competentes los Juzgados y Tribunales de la Ciudad de Logroño. Los precios de esta tarifa no incluyen el IVA. MAREFIX, S.L.U., se reserva el derecho a cambiar precios, envasados o artículos en stock sin previo aviso.

Este catálogo es un documento de información comercial. Los datos, imágenes, precios o información técnica son orientativos. MAREFIX, S.L.U., se reserva el derecho a modificar sin previo aviso el diseño de sus productos. Las imágenes de este catálogo son ilustraciones informativas sin ningún valor contractual, pudiendo no coincidir con el modelo original.

This catalogue is a commercial information document. All data, images, prices or technical information are illustrative. MAREFIX, S.L.U., reserves all rights to modify the design of its products without prior notice. The images contained in this catalogue have an informative purpose and no contractual value, being possible to differ from the original models.

Ce catalogue est un document d'information commerciale. Les données, images, prix ou information technique sont à titre indicatif. MAREFIX, S.L.U., se réserve le droit de modifier sans préavis la conception de ses produits. Les images de ce catalogue sont des illustrations sans aucune valeur contractuelle, pouvant être différente du modèle original.

COD.	PAG.	COD.	PAG.	COD.	PAG.	COD.	PAG.	COD.	PAG.	COD.	PAG.
03064	87	25164	67	44083	46	48102	56	60504	39	80014	162
03070	84	37093	73	44084	46	60135	41	60505	39	80015	162
03071	84	37094	73	44085	46	60136	41	60506	39	80016	162
03072	84	37095	73	44086	46	60137	41	60507	39	80017	162
03073	84	37096	73	44112	46	60138	41	60508	39	80018	162
03074	84	38103	53	44113	46	60139	41	60509	39	80019	162
03075	84	38121	153	44114	46	60140	41	60510	39	80020	163
03273	88	38122	153	44115	46	60141	41	60511	39	80021	163
03274	88	38123	153	44116	46	60142	41	60512	39	80022	163
03296	84	38124	153	44117	46	60143	41	60513	39	80023	163
03297	84	38125	153	44118	46	60144	41	60514	39	80024	163
03298	84	38126	153	44119	46	60322	40	64065	76	80025	163
03299	84	38127	153	48011	56	60323	40	64066	77	80026	163
03300	84	38128	153	48012	56	60324	40	64067	77	80027	163
03301	84	38129	153	48013	56	60325	40	65001	66	80028	163
03302	84	38130	153	48014	56	60326	40	65002	66	80029	163
03303	84	38131	153	48015	57	60327	40	65003	66	80030	163
03357	87	38132	153	48016	57	60328	40	65004	66	80031	163
03370	84	38133	153	48017	57	60329	40	65005	66	80032	163
03371	84	38134	153	48018	57	60330	40	65006	66	80065	163
03372	84	38135	153	48019	57	60331	40	65007	66	80066	163
03373	84	38136	153	48020	57	60332	40	65008	66	80067	163
03391	84	38137	153	48055	56	60333	40	65009	66	80071	162
03392	84	38138	153	48059	56	60334	40	65010	66	80072	162
18100	65	38152	151	48060	56	60335	40	65011	66	80073	162
18105	65	38153	151	48062	56	60336	40	65012	66	80074	162
18110	65	38192	53	48063	56	60337	40	65017	66	80079	162
18115	65	38193	53	48070	56	60341	40	65018	66	80081	162
18120	65	38194	53	48083	56	60342	40	65019	66	80083	163
18125	65	38195	53	48084	56	60343	40	65020	66	80084	163
18130	65	38197	53	48085	56	60344	40	65089	66	80087	163
18135	65	38199	53	48086	56	60345	40	65090	66	80102	162
18140	65	38300	53	48087	56	60346	40	65115	66	80103	163
18145	65	38620	53	48088	56	60347	40	65116	66	80104	163
18150	65	38825	53	48089	56	60348	40	65117	66	80105	163
18155	65	38830	53	48090	56	60349	40	65118	66	80106	163
19001	72	41242	75	48091	56	60350	40	65119	66	84006	94
19002	72	41243	75	48092	56	60351	40	65120	66	84007	92
19003	72	41244	75	48093	56	60352	40	65159	66	84008	93
19004	72	41245	75	48094	56	60353	40	65160	66	84009	94
19005	72	44077	46	48095	56	60354	40	65161	66	84010	93
19060	72	44078	46	48096	56	60355	40	65162	66	84011	93
19061	72	44079	46	48097	56	60356	40	80010	162	84012	95
19062	72	44080	46	48098	56	60501	39	80011	162	84013	92
19063	72	44081	46	48100	56	60502	39	80012	162	84022	92
25163	67	44082	46	48101	56	60503	39	80013	162	84027	95

COD.	PAG.	COD.	PAG.	COD.	PAG.	COD.	PAG.	COD.	PAG.	COD.	PAG.
84029	96	90020	60	93038	74	97026	70	99016	157	99193	156
84030	94	91081	158	93039	75	97027	70	99017	157	99194	156
84031	95	91082	158	93040	75	97028	70	99018	157	99195	156
84032	96	91091	135	93041	75	97029	70	99019	157	99196	156
84039	97	91092	135	93042	75	97030	71	99020	157	99197	156
84040	97	91093	135	93250	75	97031	71	99021	157	99198	156
84041	97	91094	135	93251	75	97032	71	99035	159	A6008	150
84042	97	91095	135	93252	75	97033	71	99036	159	A6010	150
84043	97	91108	135	93260	74	97034	71	99037	159	A6012	150
84044	97	93001	75	93261	74	97035	70	99038	158	A6014	150
84045	97	93002	75	96001	40	97089	71	99050	157	A6015	150
84053	96	93003	75	96002	40	97090	71	99051	157	A6016	150
85007	104	93004	75	96003	40	97091	71	99052	157	A6018	150
85008	104	93005	75	96004	40	97092	71	99053	157	A6020	150
850011	104	93006	75	96005	40	97093	71	99054	157	A6022	150
850028	104	93007	75	96006	40	97118	70	99055	157	A6025	150
850035	104	93008	75	96007	40	97119	70	99056	157	A6026	150
850066	104	93009	75	96008	40	97120	70	99057	157	A6028	150
87300	47	93010	75	96009	40	97126	70	99058	157	A6032	150
87301	47	93011	74	96010	40	97127	70	99059	157	A6035	150
87302	47	93012	74	96011	40	97128	70	99060	157	A6037	150
87303	47	93013	74	96024	40	97175	70	99061	157	A6040	150
87304	47	93014	74	96025	40	97177	70	99062	157	A6042	150
87305	47	93015	74	96026	40	97178	70	99063	158	A6047	150
87306	47	93016	74	96027	40	97183	70	99064	158	A6050	150
87307	47	93017	74	97005	70	97184	70	99065	158	A6054	150
87308	47	93018	74	97006	70	97214	71	99066	158	A6060	150
87309	47	93019	74	97007	70	97215	71	99067	158	A6063	150
87310	47	93020	74	97008	70	97216	71	99068	158	A6I012	150
87311	47	93021	74	97009	70	97220	71	99069	158	A6I015	150
87312	47	93022	74	97010	70	97221	71	99070	158	A6I016	150
87313	47	93023	74	97011	70	97258	70	99071	157	A6I018	150
87314	47	93024	74	97012	70	99001	156	99072	157	A6I022	150
87315	47	93025	74	97013	70	99002	156	99073	157	A6I026	150
87316	47	93026	74	97014	70	99003	156	99074	158	A6I028	150
87317	47	93027	74	97015	70	99004	156	99075	158	A6I032	150
87318	47	93028	74	97016	70	99005	156	99076	158	A6I035	150
87319	47	93029	74	97017	70	99006	157	99077	158	A6I042	150
87320	47	93030	74	97018	70	99007	157	99078	158	A6I048	150
87321	47	93031	74	97019	70	99008	157	99079	158	A6I054	150
87322	47	93032	74	97020	70	99010	157	99080	158	A6I060	150
87323	47	93033	74	97021	70	99011	157	99081	158	A6Z08	150
87324	47	93034	74	97022	70	99012	157	99082	158	A6Z10	150
90001	60	93035	74	97023	70	99013	157	99083	158	A6Z12	150
90002	60	93036	74	97024	70	99014	157	99084	158	A6Z14	150
90019	60	93037	74	97025	70	99015	157	99164	157	A6Z15	150

COD.	PAG.	COD.	PAG.	COD.	PAG.	COD.	PAG.	COD.	PAG.	COD.	PAG.
A6Z16	150	ABCIE28	152	ACGA14C	43	ACTO10L	42	AFOM16	138	AR20080	136
A6Z18	150	ABCIE32	152	ACGA16C	43	ACTO12C	42	AM8050	149	AR21080	136
A6Z20	150	ABCIE35	152	ACGE10C	44	ACTO12L	42	AM8063	149	AR21090	136
A6Z22	150	ABCIE37	152	ACGE12C	44	ACTO14C	42	AM8075	149	AR22100	136
A6Z25	150	ABCIE40	152	ACGF08C	44	ACTO14L	42	AM8090	149	AR22110	136
A6Z26	150	ABCIE42	152	ACGF10C	44	ACTO16C	42	AM8110	149	AR22120	136
A6Z28	150	ABCIE47	152	ACGF12C	44	ACTO16L	42	AM8125	149	AR23130	136
A6Z32	150	ABCIE50	152	ACGF08C	44	ACTO208C	42	AM8160	149	ARE0018	148
A6Z35	150	ABCLD12	152	ACGF10C	44	ACTO208L	42	AM8200	149	ARE0022	148
A6Z37	150	ABCLD14	152	ACGF12C	44	ACTO20C	42	AM8250	149	ARE0028	148
A6Z40	150	ABCLD16	152	ACINN08C	43	ACTO210C	42	AM8315	149	ARE0035	148
A6Z42	150	ABCLD20	152	ACINN08L	43	ACTO210L	42	AP023025	146	ARE0040	148
A6Z47	150	ABCLD28	152	ACINN10C	43	ACTO212C	42	AP026028	146	ARE0048	148
A6Z50	150	ABCLS12	152	ACINN10L	43	ACTO212L	42	AP029031	146	ARE0054	148
A6Z54	150	ABCLS14	152	ACINZ08C	43	ACTO214C	42	AP032035	146	ARE0060	148
A6Z60	150	ABCLS16	152	ACINZ08L	43	ACTO214L	42	AP036039	146	ARE0070	148
A6Z63	150	ABCLS20	152	ACINZ10C	43	ACTO216C	42	AP040043	146	ARE0075	148
ABA060250	138	ABCLS25	152	ACINZ10L	43	ACTO216L	42	AP044047	146	ARE0083	148
ABA060375	138	ABCLS28	152	ACPI08C	43	ACTO220C	42	AP048051	146	ARE0090	148
ABA060500	138	ABMUL15B	153	ACPI08L	43	ACTO8808C	42	AP052055	146	ARE0100	148
ABA060750	138	ABMUL15G	153	ACPI10C	43	ACTO8808L	42	AP056059	146	ARE0110	148
ABA061000	138	ABMUL20B	153	ACPI10L	43	ACTO8810C	42	AP060063	146	ARE0115	148
ABA061250	138	ABMUL20G	153	ACPI12C	43	ACTO8810L	42	AP064067	146	ARE0125	148
ABA081500	138	ABMUL25B	153	ACPI12L	43	ACTO8812C	42	AP068073	146	ARE0140	148
ABA082000	138	ABMUL25G	153	ACPZ08C	42	ACTO8812L	42	AP074079	146	ARE0150	148
ABA082250	138	ACAF08C	44	ACPZ08L	42	ACTO8816C	42	AP080085	146	ARE0160	148
ABA082500	138	ACAF10C	44	ACPZ10C	42	ACTO8816L	42	AP086091	146	ARE0200	148
ABA083000	138	ACAF12C	44	ACPZ10L	42	ACTO8820C	42	AP092097	146	ARE0250	148
ABA083500	138	ACAFI08C	44	ACPZ12C	42	ACUNAAG	187	AP098103	146	ARE0300	148
ABA084000	138	ACAFI10C	44	ACPZ12L	42	AD6012	151	AP104112	146	ARE0315	148
ABA084500	138	ACAFI12C	44	ACTAP33	187	AD6015	151	AP113121	146	AREA20018	148
ABA085000	138	ACAR08C	43	ACTAP40	187	AD6018	151	AP122130	146	AREA20022	148
ABA086000	138	ACAR10C	43	ACTAP42	187	AD6022	151	AP131139	146	AREA20028	148
ABA103000	138	ACAR12C	43	ACTAP48	187	AD6028	151	AP140148	146	AREA20035	148
ABA103500	138	ACAR14C	43	ACTAZ33	187	AD61012	151	AP149161	146	AREA20040	148
ABA104000	138	ACAR16C	43	ACTAZ40	187	AD61015	151	AP162174	146	AREA20048	148
ABA105000	138	ACBPZ33	186	ACTAZ42	187	AD61018	151	AR14025	136	AREA20054	148
ABA106000	138	ACBPZ40	186	ACTAZ48	187	AD61022	151	AR16030	136	AREA20060	148
ABA108000	138	ACBPZ42	186	ACTAZ50	187	AD61028	151	AR17040	136	AREA20075	148
ABCIE12	152	ACBPZ48	186	ACTAZ60	187	AFOIM06	138	AR18040	136	AREA20090	148
ABCIE15	152	ACBPZ50	186	ACTENALV	186	AFOIM08	138	AR18050	136	AREA20110	148
ABCIE16	152	ACBPZ60	186	ACTENALZ	186	AFOIM10	138	AR19050	136	AREA20115	148
ABCIE18	152	ACBTENZ	186	ACTENTOZ	186	AFOM06	138	AR19060	136	AREA20125	148
ABCIE20	152	ACGA08C	43	ACTO08C	42	AFOM08	138	AR19070	136	AREA20140	148
ABCIE22	152	ACGA10C	43	ACTO08L	42	AFOM10	138	AR20060	136	AREA20160	148
ABCIE25	152	ACGA12C	43	ACTO10C	42	AFOM12	138	AR20070	136	AREA20200	148

COD.	PAG.	COD.	PAG.	COD.	PAG.	COD.	PAG.	COD.	PAG.	COD.	PAG.
AREA20250	148	ARIA20048	147	ASR-12	44	BRM36140	101	CC02	80	CM0150	175
AREA40018	148	ARIA20054	147	ATB0630	151	BRM36200	101	CC02P	80	CM0155	175
AREA40022	148	ARIA20060	147	ATB0640	151	BRM48200	101	CC13	81	CM0160	175
AREA40028	148	ARIA20075	147	ATB0650	151	BRM48290	101	CC14	81	CM0165	175
AREA40035	148	ARIA20090	147	ATGZ4530	151	BRR25100	102	CC17	80	CM0170	175
AREA40040	148	ARIA20110	147	ATGZ4535	151	BRR36140	102	CC30	80	CM0175	175
AREA40048	148	ARIA20115	147	ATGZ4540	151	BRR36200	102	CC30P	80	CM0180	175
AREA40054	148	ARIA20125	147	ATGZ5030	151	BRR48200	102	CC32	81	CM0185	175
AREA40060	148	ARIA20140	147	ATGZ5040	151	BRR48290	102	CC37	81	CM0190	175
AREA40075	148	ARIA20160	147	ATZ0840	151	BRV25100	101	CC38	81	CM0195	175
AREA40090	148	ARIA20200	147	ATZ0860	151	BRV36140	101	CC40	80	CM0200	175
AREA40110	148	ARIA20250	147	ATZ0880	151	BRV36200	101	CC40P	80	CM0205	175
AREA40115	148	ARIA40018	147	ATZ1050	151	BRV48200	101	CCPE385	82	CM0210	175
AREA40125	148	ARIA40022	147	ATZ1070	151	BRV48290	101	CCPE585	82	CM0215	175
AREA40140	148	ARIA40028	147	BCAM04	59	BRZ25100	102	CCVAL13	83	CM0220	175
AREA40160	148	ARIA40035	147	BCAM05	59	BRZ36140	102	CCVAL30	83	CM0225	175
AREA40200	148	ARIA40040	147	BCAM06	59	BRZ36200	102	CCVAL32	83	CM0230	175
AREA40250	148	ARIA40048	147	BCAM08	59	BRZ48200	102	CCVAL40	83	CM0235	175
ARI0018	147	ARIA40054	147	BESM04	59	BRZ48290	102	CCWT13	82	CM0240	175
ARI0022	147	ARIA40060	147	BESM05	59	C08	84	CCWT32	82	CM0245	175
ARI0028	147	ARIA40075	147	BESM06	59	C10	84	CD01	90	CM0250	175
ARI0035	147	ARIA40090	147	BESM08	59	C12	84	CEANZ06035	61	CM0255	175
ARI0040	147	ARIA40110	147	BGAM04	59	C16	84	CEANZ06065	61	CM0260	176
ARI0048	147	ARIA40115	147	BGAM05	59	C20	84	CINPEI1708	104	CM0270	176
ARI0054	147	ARIA40125	147	BGAM06	59	C24	84	CINPEZ1208	104	CM0275	176
ARI0060	147	ARIA40140	147	BGAM08	59	CB01	88	CINPEZ1708	104	CM0280	176
ARI0070	147	ARIA40160	147	BRA25100	101	CB02	88	CM0001	172	CM0310	176
ARI0075	147	ARIA40200	147	BRA36140	101	CB03	88	CM0010	172	CM0315	176
ARI0083	147	ARIA40250	147	BRA36200	101	CB04	88	CM0020	172	CM0330	176
ARI0090	147	AS008016	146	BRA48200	101	CB07	88	CM0030	172	CM0350	177
ARI0100	147	AS012022	146	BRA48290	101	CB08	88	CM0035	172	CM0360	177
ARI0110	147	AS016027	146	BRDET25100	102	CB09	88	CM0040	172	CM0365	177
ARI0115	147	AS020032	146	BRDET36150	102	CB10	88	CM0050	173	CM0370	177
ARI0125	147	AS025040	146	BRDET36200	102	CB11	88	CM0055	173	CM0375	177
ARI0140	147	AS030045	146	BRDET48200	102	CB113357	88	CM0060	173	CM0380	177
ARI0150	147	AS035050	146	BRDET48300	102	CBA06	88	CM0070	173	CM0385	177
ARI0160	147	AS040060	146	BRDET48370	102	CBA08	88	CM0075	173	CM0390	177
ARI0200	147	AS050070	146	BRDET76370	102	CBA10	88	CM0080	173	CM0400	177
ARI0250	147	AS060080	146	BRG25100	101	CBA12	88	CM0090	173	CM0405	177
ARI0300	147	AS070090	146	BRG36140	101	CBAMD12	88	CM0095	173	CM0420	178
ARI0315	147	AS080100	146	BRG36200	101	CBAMD16	88	CM0100	174	CM0425	178
ARIA20018	147	AS090110	146	BRG48200	101	CBAMD22	88	CM0110	174	CM0430	178
ARIA20022	147	AS100120	146	BRG48290	101	CBAMD30	88	CM0120	174	CM0435	178
ARIA20028	147	AS110130	146	BRID25100	102	CBV06	84	CM0130	174	CM0440	178
ARIA20035	147	AS120140	146	BRID25200	102	CC01	80	CM0135	174	CM0445	178
ARIA20040	147	AS130150	146	BRM25100	101	CC01P	80	CM0145	175	CM0460	178

COD.	PAG.	COD.	PAG.	COD.	PAG.	COD.	PAG.	COD.	PAG.	COD.	PAG.
CM0470	178	CM0780	182	CSCO18	87	GPI006	149	HA23130	136	HCL01	51
CM0480	178	CM0790	183	CSCO24	87	GPI008	149	HA8090	76	HCL02	51
CM0490	178	CM0795	183	CSCO28	87	GPI010	149	HA8110	76	HCL03	51
CM0495	178	CM0800	183	CSM01	89	GPI012	149	HA8140	76	HCL04	51
CM0500	179	CM0805	183	DW06040	151	GPI014	149	HA8170	76	HCL05	51
CM0505	179	CM0810	183	DW06050	151	GPI016	149	HA8200	76	HCL06	51
CM0510	179	CM0820	183	DW06060	151	GPI018	149	HA8250	76	HCL26	55
CM0515	179	CM0825	183	DW06070	151	GPI020	149	HA8300	76	HFB0825	100
CM0520	179	CM0830	183	DW06080	151	GPI022	149	HAN01	58	HFB100125	100
CM0530	179	CM0835	183	DW08050	151	GPI025	149	HAN02	58	HFB1025	100
CM0535	179	CM0845	183	DW08060	151	GPI026	149	HAN03	58	HFB10290	100
CM0540	179	CM0860	183	DW08070	151	GPI028	149	HAN04	58	HFB1248	100
CM0545	179	CM0865	183	DW08080	151	GPI032	149	HAN05	58	HFB1425	100
CM0550	179	CM0870	183	DW08090	151	GPI040	149	HAN11	58	HFB1436	100
CM0555	179	CM0875	183	DW08100	151	GPI042	149	HAN12	58	HFB1576	100
CM0560	179	CM0880	183	DW08110	151	GPI047	149	HAN13	58	HFB1625	100
CM0565	179	CM0885	183	DW08120	151	GPI050	149	HAN14	58	HFB1648	100
CM0570	179	CM0900	183	DW08130	151	GPU016	149	HBD01	103	HFB1848	100
CM0575	179	CM0905	183	DW10080	151	GPU018	149	HBD02	103	HFB2025	100
CM0590	179	CM0910	183	DW10100	151	GPU020	149	HBG01	78	HFB2036	100
CM0595	179	CM1001	87	DW10110	151	GPU022	149	HBM08	78	HFB2048	100
CM0610	179	CM1003	87	DW10120	151	GPU025	149	HBM10	78	HFB2076	100
CM0615	179	CM1004	87	DW10130	151	GPU028	149	HBN01	103	HFB22125	100
CM0620	179	CM12	87	DW10140	151	GPU032	149	HBN02	103	HFB2536	100
CM0625	179	CP01	86	DW10150	151	GPU037	149	HBT01	78	HFB2548	100
CM0630	179	CP03	90	DW10180	151	GPU040	149	HBV08	78	HFB2576	100
CM0635	179	CP05	86	DW10200	151	GPU050	149	HBV10	78	HFB2936	100
CM0650	180	CP07	86	ESELF38	65	GPU063	149	HC14025	136	HFB2948	100
CM0655	180	CP10	87	ESTINVN	123	HA14025	136	HC16030	136	HFB2976	100
CM0660	180	CP11	85	ESTINVZ	123	HA16030	136	HC17040	136	HFB3036	100
CM0670	180	CP16	86	EXTR01	55	HA17040	136	HC18040	136	HFB3636	100
CM0675	180	CP17	85	EXTR02	55	HA18040	136	HC18050	136	HFB3648	100
CM0680	180	CP17BA	85	FAC10070	76	HA18050	136	HC19050	136	HFB3676	100
CM0690	180	CP18	86	FAC10090	76	HA19050	136	HC19060	136	HFB3736	100
CM0695	180	CP19	86	FAC10110	76	HA19060	136	HC19070	136	HFB3748	100
CM0700	180	CP30	85	FAC10130	76	HA19070	136	HC20050	136	HFB3776	100
CM0710	181	CP30BA	85	FAC10150	76	HA20050	136	HC20060	136	HFB3948	100
CM0715	181	CS01	89	FAC10180	76	HA20060	136	HC20070	136	HFB4348	100
CM0720	181	CS02	89	GFOIM06	138	HA20070	136	HC20080	136	HFB4576	100
CM0730	181	CS03	89	GFOIM08	138	HA20080	136	HC21070	136	HFB50125	100
CM0735	181	CS04	90	GFOIM10	138	HA21070	136	HC21080	136	HFB5348	100
CM0740	181	CS08	90	GFOM06	138	HA21080	136	HC21090	136	HFB5390	100
CM0750	182	CS21	89	GFOM08	138	HA21090	136	HC21100	136	HFB5476	100
CM0760	182	CSCO10	87	GFOM10	138	HA21100	136	HC22110	136	HFB72125	100
CM0770	182	CSCO12	87	GFOM12	138	HA22110	136	HC22120	136	HFB7576	100
CM0775	182	CSCO14	87	GFOM16	138	HA22120	136	HC23130	136	HFB7788	100

COD.	PAG.	COD.	PAG.	COD.	PAG.	COD.	PAG.	COD.	PAG.	COD.	PAG.
HFB7888	100	HFN5348	100	HNU0800	68	HTFB02	103	HTV07	72	PAZ22525	137
HFB85125	100	HFN5390	100	HNU10	68	HTFG01	103	HTV08	72	PAZ22530	137
HFC01	152	HFN5476	100	HNU100	68	HTFN01	103	HTV09	72	PAZ25040	137
HFC02	152	HFN72125	100	HNU60	68	HTFN02	103	HTV10	72	PAZ25050	137
HFC03	152	HFN7576	100	HNU80	68	HTL02	69	HTV11	72	PAZ29050	137
HFC04	152	HFN7788	100	HRN01	60	HTL05	69	HTVE015	72	PAZ29060	137
HFC05	152	HFN7888	100	HRNV01	60	HTL06	69	HTVE02	72	PAZ29070	137
HFC06	152	HFN85125	100	HSF02	77	HTL07	69	HTVE03	72	PAZ34030	137
HFF01	153	HFQ02	153	HSF310	77	HTLA1216	72	HTVE04	72	PAZ34040	137
HFF02	153	HFQ03	153	HSF320	77	HTLAUE04	73	HTVE07	72	PAZ34050	137
HFN0825	100	HFQ04	153	HSF340	77	HTLAUE05	73	HTVE08	72	PAZ34060	137
HFN100125	100	HFQ05	153	HSF410	77	HTLAUE06	73	HTVE09	72	PAZ34070	137
HFN1025	100	HGBU06	69	HSF412	77	HTLAUE08	73	HTVE10	72	PAZ34080	137
HFN10290	100	HGBU08	69	HSF414	77	HTLAUE09	73	HTVE11	72	PEC3220	143
HFN1248	100	HGBU10	69	HSF510	77	HTLAUE10	73	HTVT01	72	PEIX9004	142
HFN1425	100	HGBU100	69	HSF520	77	HTLAUE11	73	HTVT02	72	PERI090	143
HFN1436	100	HGBU60	69	HSF540	77	HTLAUE12	73	KITSH3	80	PEX045	143
HFN1576	100	HGBU80	69	HTC04	67	HTLAUE13	73	MOR09	131	PEX090	143
HFN1625	100	HGSB04	77	HTC05	67	HTLAUT01	72	MOR11	131	PEX180	143
HFN1648	100	HGSB06	77	HTC06	67	HTLAUT02	72	MOR13	131	PEXL41	144
HFN1848	100	HGSB08	77	HTC07	67	HTLAUT03	72	MORM06	131	PEXT41	144
HFN1890	101	HGSB10	77	HTC08	67	HTLAUT04	73	MORM08	131	PEZ045	141
HFN2025	100	HI10110	76	HTC10	67	HTLAUT05	73	MORM10	131	PEZ090	141
HFN2036	100	HI10140	76	HTC100	67	HTLAUT06	73	MORM12	131	PEZ180	141
HFN2048	100	HI10160	76	HTC12	67	HTLAUT07	72	MRRZ0420	53	PG101	190
HFN2076	100	HI10180	76	HTC120	67	HTLAUT08	73	MRRZ0620	53	PG102	190
HFN22125	100	HI10200	76	HTC14	67	HTLAUT09	73	MRRZ0630	53	PG1020	190
HFN2536	100	HI10220	76	HTC140	67	HTLAUT10	73	MRRZ0825	53	PG104	190
HFN2548	100	HI10260	76	HTC1410	55	HTLAUT11	72	MRRZ0830	53	PG1040	190
HFN2576	100	HI1070	76	HTC1410	67	HTS02	69	MRRZ1030	53	PG106	190
HFN2690	101	HI1090	76	HTC1614	55	HTS05	69	MRRZ1235	53	PG108	190
HFN2936	100	HI8095	76	HTC1680	67	HTS06	69	MRRZ1650	53	PG109	190
HFN2948	100	HI8115	76	HTC50	67	HTS07	69	MRRZ5322	53	PG111	190
HFN2976	100	HI8135	76	HTC60	67	HTTSI21	74	PACA04	58	PG112	190
HFN3036	100	HI8155	76	HTC80	67	HTTSI22	74	PACA05	58	PG113	190
HFN3636	100	HI8175	76	HTCB05	67	HTTSI23	74	PACA06	58	PG114	190
HFN3648	100	HI8195	76	HTCB06	67	HTTSI24	74	PACA08	58	PG115	190
HFN3676	100	HIA8095	76	HTCB08	67	HTTSI25	74	PAES04	58	PG116	190
HFN3690	101	HIA8115	76	HTCB10	67	HTTSI26	74	PAES05	58	PG117	190
HFN3736	100	HIA8135	76	HTCB100	67	HTTSI27	74	PAES06	58	PG118	190
HFN3748	100	HIA8155	76	HTCB12	67	HTTSI28	74	PAES08	58	PG119	190
HFN3776	100	HIA8175	76	HTCB120	67	HTTSI30	74	PAGA04	58	PG120	190
HFN3948	100	HIA8195	76	HTCB50	67	HTV015	72	PAGA05	58	PG121	190
HFN4348	100	HNU06	68	HTCB60	67	HTV03	72	PAGA06	58	PG1220	190
HFN4576	100	HNU08	68	HTCB80	67	HTV04	72	PAGA08	58	PG1240	190
HFN50125	100	HNU080	68	HTFB01	103	HTV06	72	PAZ22520	137	PG1420	190

COD.	PAG.	COD.	PAG.	COD.	PAG.	COD.	PAG.	COD.	PAG.	COD.	PAG.
PG1440	190	PS1061	191	PS3T1246	192	PSPZ384035	140	REMFL4018	167	REMNO4012	166
PG1620	190	PS1216	191	PS3T1416	192	PSPZ384040	140	REMFL4020	167	REMNO4014	166
PG1640	190	PS1221	191	PS3T1421	192	PSPZ384050	140	REMFL4025	167	REMNO4016	166
PG1840	190	PS1231	191	PS3T1431	192	PSPZ384060	140	REMFL4814	167	REMNO4018	166
PG2040	190	PS1246	191	PS3T1446	192	PTGXZ0840	142	REMFL4816	167	REMNO4020	166
PG620	190	PS1261	191	PS3T1621	192	PTGXZ0860	142	REMFL4818	167	REMNO4025	166
PG640	190	PS1416	191	PS3T1631	192	PTGXZ1040	142	REMFL4824	167	REMNO4030	166
PG820	190	PS1421	191	PS3T1646	192	PTGXZ1060	142	REMFL4830	167	REMNO4035	166
PG840	190	PS1431	191	PS3T1821	192	PTGZ230620	141	REMFL4835	167	REMNO4806	166
PMXC1/2	144	PS1446	191	PS3T1831	192	PTGZ230820	141	REMFL4840	167	REMNO4808	166
PMXC8-10	144	PS1461	191	PS3T1846	192	PTGZ230830	141	REMFL4845	167	REMNO4810	166
PPG271812	140	PS1516	191	PS3T2021	192	PTGZ340830	141	REMFL4850	167	REMNO4812	166
PPG283018	140	PS1521	191	PS3T2046	192	PTGZ341030	141	REMIN3206	168	REMNO4814	166
PPG384020	140	PS1621	191	PS6516	191	PTP2718	144	REMIN3208	168	REMNO4816	166
PPG402015	140	PS1631	191	PS6521	191	PTP2830	144	REMIN3212	168	REMNO4818	166
PPRX01	142	PS1646	191	PS6526	191	PTP3840	144	REMIN3215	168	REMNO4820	166
PPX412115	141	PS1661	191	PS6531	191	PTP4121	144	REMIN4008	168	REMNO4822	166
PPX412120	141	PS1821	191	PSPH2718	140	PTP4141	144	REMIN4010	168	REMNO4825	166
PPX4121202M	141	PS1846	191	PSPH3840	140	PUNEX41213	143	REMIN4012	168	REMNO4830	166
PPX412125	141	PS2021	191	PSPHX2718	141	PUNI41211	143	REMIN4016	168	REMNO4835	166
PPX414115	141	PS2046	191	PSPHX3840	141	PUNI41212	143	REMIN4810	168	REMNO4840	166
PPX414120	141	PS2226	191	PSPM3220	143	PUNI41213	143	REMIN4812	168	REMNO4850	166
PPX4141202M	141	PS2246	191	PSPM3840	143	PUNI41214	143	REMIN4816	168	REMNO6008	166
PPX414125	141	PS2426	191	PSPM4141	143	REMBL3208	167	REMIN4818	168	REMNO6010	166
PPZ201010	140	PS2446	191	PSPRXH4121	142	REMBL3210	167	REMIN4820	168	REMNO6012	166
PPZ250808	140	PS2526	191	PSPRXV4121	142	REMBL3212	167	REMANU	168	REMNO6016	166
PS0411	191	PS2546	191	PSPS322037	141	REMBL4008	167	REMNE3208	167	REMNO6018	166
PS0511	191	PS3T0511	192	PSPS322054	141	REMBL4010	167	REMNE3210	167	REMNO6022	166
PS0516	191	PS3T0516	192	PSPUX412100	142	REMBL4012	167	REMNE3212	167	REMNO6026	166
PS0521	191	PS3T0611	192	PSPUX412145	142	REMBL4016	167	REMNE4008	167	REMNO6030	166
PS0611	191	PS3T0616	192	PSPV2718	140	REMBL4810	167	REMNE4010	167	REMTIJ	168
PS0616	191	PS3T0621	192	PSPV3840	140	REMBL4812	167	REMNE4012	167	REMTUER	168
PS0621	191	PS3T0811	192	PSPX412115	142	REMBL4816	167	REMNE4016	167	TABA4832	113
PS0626	191	PS3T0816	192	PSPX412130	142	REMCA4008	166	REMNE4810	167	TABA4838	113
PS0631	191	PS3T0821	192	PSPX412145	142	REMCA4010	166	REMNE4812	167	TABA4845	113
PS0811	191	PS3T0826	192	PSPX414110	142	REMCA4012	166	REMNE4816	167	TABA4850	113
PS0816	191	PS3T0831	192	PSPX414115	142	REMCA4016	166	REMNO3206	166	TABA5538	113
PS0821	191	PS3T1011	192	PSPX414130	142	REMCA4810	166	REMNO3208	166	TABA5545	113
PS0846	191	PS3T1016	192	PSPX414145	142	REMCA4812	166	REMNO3210	166	TABA5555	113
PS0916	191	PS3T1021	192	PSPX414160	142	REMCA4814	166	REMNO3212	166	TABA5565	113
PS0921	191	PS3T1026	192	PSPX414175	142	REMCA4816	166	REMNO3214	166	TABA6360	113
PS1016	191	PS3T1031	192	PSPZ271820	140	REMCA4818	166	REMNO3216	166	TABA6370	113
PS1021	191	PS3T1046	192	PSPZ271830	140	REMEXT	168	REMNO3218	166	TABA6385	113
PS1026	191	PS3T1216	192	PSPZ384020	140	REMFL4012	167	REMNO4006	166	TABATX4832	113
PS1031	191	PS3T1226	192	PSPZ384025	140	REMFL4014	167	REMNO4008	166	TABATX4838	113
PS1046	191	PS3T1231	192	PSPZ384030	140	REMFL4016	167	REMNO4010	166	TABATX4845	113

COD.	PAG.	COD.	PAG.	COD.	PAG.	COD.	PAG.	COD.	PAG.	COD.	PAG.
TABATX4850	113	TARAS6060	61	TAU1663040	122	TAU63080	122	TBAZ06060	124	TBAZ10150	124
TABATX5538	113	TARAS6080	61	TAU1663050	122	TAU63090	122	TBAZ06070	124	TBAZ10160	124
TABATX5545	113	TARAS8070	61	TAU1663060	122	TAU63100	122	TBAZ06080	124	TBAZ10180	124
TABATX5555	113	TARAS8090	61	TAU1663080	122	TAU63110	122	TBAZ06090	124	TBAZ10200	124
TABATX5565	113	TARAS8110	61	TAU1663100	122	TAU63120	122	TBAZ06100	124	TBAZ12060	124
TABATX6310	113	TARAS8130	61	TAU1663110	122	TAU63130	122	TBAZ06110	124	TBAZ12070	124
TABATX6360	113	TARAS8150	61	TAU1663120	122	TAU63140	122	TBAZ06120	124	TBAZ12080	124
TABATX6370	113	TARAS8180	61	TAU1663130	122	TAU63150	122	TBAZ07030	124	TBAZ12090	124
TABATX6385	113	TARAS8200	61	TAU1663140	122	TAU63160	122	TBAZ07040	124	TBAZ12100	124
TACEI4213	114	TARNEG14	108	TAU1663150	122	TAU63180	122	TBAZ07050	124	TBAZ12120	124
TACEI4222	114	TARNEG16	108	TAU1863016	122	TAU63200	122	TBAZ07060	124	TBAZ12130	124
TACEI4232	114	TARNEG18	108	TAU1863019	122	TAU63220	122	TBAZ07070	124	TBAZ12140	124
TACEN4213	114	TARNEG25	108	TAU1863025	122	TAU63240	122	TBAZ07080	124	TBAZ12150	124
TACEN4222	114	TARNEGI14	108	TAU1863032	122	TBAI06040	124	TBAZ07090	124	TBAZ12160	124
TACEN4232	114	TARNEGI16	108	TAU1863040	122	TBAI06050	124	TBAZ07100	124	TBAZ12180	124
TACEP4213	114	TARNEGI18	108	TAU1863050	122	TBAI06060	124	TBAZ07110	124	TBAZ12200	124
TACEP4222	114	TARNEGI25	108	TAU1863060	122	TBAI06070	124	TBAZ07120	124	TBAZ12220	124
TACEP4232	114	TARNEI14	108	TAU1863080	122	TBAI08050	124	TBAZ07150	124	TBAZ12240	124
TACEZ4213	114	TARNEI16	108	TAU1863100	122	TBAI08060	124	TBAZ08030	124	TBAZ12260	124
TACEZ4222	114	TARNEI18	108	TAU1863110	122	TBAI08070	124	TBAZ08040	124	TBAZ14100	124
TACEZ4232	114	TARNEI25	108	TAU1863120	122	TBAI08080	124	TBAZ08045	124	TBCEI4214	114
TAHE08AR	108	TARNEI30	108	TAU1863130	122	TBAI08100	124	TBAZ08050	124	TBCEI4223	114
TAHE08BP	108	TARNEIC30	108	TAU1863140	122	TBAI08120	124	TBAZ08060	124	TBCEL4214	114
TAHE08NE	108	TARNEIPAR	108	TAU1863150	122	TBAI10060	124	TBAZ08070	124	TBCEL4223	114
TAHE08RJ	108	TARNEZ14	108	TAU2563016	122	TBAI10080	124	TBAZ08080	124	TBCEN4214	114
TAHE08VN	108	TARNEZ16	108	TAU2563019	122	TBAI10100	124	TBAZ08090	124	TBCEN4223	114
TAHE10AR	108	TARNEZ18	108	TAU2563025	122	TBAI10120	124	TBAZ08100	124	TBCEP4214	114
TAHE10BP	108	TARNEZ25	108	TAU2563032	122	TBART06050	124	TBAZ08110	124	TBCEP4223	114
TAHE10NE	108	TAU1463016	122	TAU2563040	122	TBART06060	124	TBAZ08120	124	TBCEZ4214	114
TAHE10RJ	108	TAU1463019	122	TAU2563050	122	TBART06070	124	TBAZ08130	124	TBCEZ4223	114
TAHE10VN	108	TAU1463025	122	TAU2563060	122	TBART08050	124	TBAZ08140	124	TBE143509	107
TANCORA40	68	TAU1463032	122	TAU2563080	122	TBART08060	124	TBAZ08150	124	TBE143513	107
TANCORA47	68	TAU1463040	122	TAU2563100	122	TBART08070	124	TBAZ08160	124	TBE143516	107
TANUDO06	68	TAU1463050	122	TAU2563110	122	TBART08080	124	TBAZ08180	124	TBE143519	107
TANUDO08	68	TAU1463060	122	TAU2563120	122	TBART10060	124	TBAZ08200	124	TBE144213	107
TANUDO10	68	TAU1463080	122	TAU2563130	122	TBART10080	124	TBAZ10040	124	TBE144216	107
TAPLA1233	60	TAU1463100	122	TAU2563140	122	TBAZ05030	124	TBAZ10050	124	TBE144219	107
TAPRO05	68	TAU1463110	122	TAU2563150	122	TBAZ05040	124	TBAZ10060	124	TBE144225	107
TAPRO06	68	TAU1463120	122	TAU63016	122	TBAZ05050	124	TBAZ10070	124	TBE144232	107
TAPRO07	68	TAU1463130	122	TAU63019	122	TBAZ05060	124	TBAZ10080	124	TBE144238	107
TAPRO08	68	TAU1463140	122	TAU63025	122	TBAZ06025	124	TBAZ10090	124	TBE144813	107
TAPRO09	68	TAU1463150	122	TAU63032	122	TBAZ06030	124	TBAZ10100	124	TBE144816	107
TAPRO10	68	TAU1663016	122	TAU63040	122	TBAZ06035	124	TBAZ10110	124	TBE144819	107
TAPRO12	68	TAU1663019	122	TAU63050	122	TBAZ06040	124	TBAZ10120	124	TBE144819BP	106
TAPRO14	68	TAU1663025	122	TAU63060	122	TBAZ06045	124	TBAZ10130	124	TBE144825	107
TARAS6050	61	TAU1663032	122	TAU63070	122	TBAZ06050	124	TBAZ10140	124	TBE144832	107

COD.	PAG.	COD.	PAG.	COD.	PAG.	COD.	PAG.	COD.	PAG.	COD.	PAG.
TBE144838	107	TBE164825	107	TBE184238	107	TBE254232	107	TBEI4832	109	TBEZ6318	106
TBE144850	107	TBE164832	107	TBE184813	107	TBE254238	107	TBEI4838	109	TBEZ6319	106
TBE144860	107	TBE164838	107	TBE184816	107	TBE254813	107	TBEI5519	109	TBEZ6320	106
TBE144870	107	TBE164850	107	TBE184819	107	TBE254816	107	TBEI5522	109	TBEZ6322	106
TBE145519	107	TBE164860	107	TBE184825	107	TBE254819	107	TBEI5525	109	TBEZ6324	106
TBE145522	107	TBE164870	107	TBE184832	107	TBE254825	107	TBEI5532	109	TBEZ6325	106
TBE145525	107	TBE165519	107	TBE184838	107	TBE254832	107	TBEI5538	109	TBEZ6332	106
TBE145532	107	TBE165522	107	TBE184850	107	TBE254838	107	TBEI6315	109	TBEZ6338	106
TBE145538	107	TBE165522BP	106	TBE184860	107	TBE254850	107	TBEI6319	109	TBEZ6350	106
TBE145550	107	TBE165525	107	TBE184870	107	TBE254860	107	TBEI6325	109	TBEZ6363	106
TBE145563	107	TBE165532	107	TBE185519	107	TBE254870	107	TBEI6332	109	TBEZ6375	106
TBE145575	107	TBE165538	107	TBE185522	107	TBE255519	107	TBEI6338	109	TBEZ6380	106
TBE146310	107	TBE165550	107	TBE185525	107	TBE255522	107	TBEZ3509	106	TBEZ6390	106
TBE146311	107	TBE165563	107	TBE185532	107	TBE255525	107	TBEZ3513	106	TBH006	131
TBE146312	107	TBE165575	107	TBE185538	107	TBE255532	107	TBEZ3516	106	TBH007	131
TBE146313	107	TBE166310	107	TBE185550	107	TBE255538	107	TBEZ3519	106	TBH008	131
TBE146314	107	TBE166311	107	TBE185563	107	TBE255550	107	TBEZ4213	106	TBH010	131
TBE146315	107	TBE166312	107	TBE185575	107	TBE255563	107	TBEZ4216	106	TBI164825	111
TBE146316	107	TBE166313	107	TBE186310	107	TBE255575	107	TBEZ4219	106	TBI165525	111
TBE146318	107	TBE166314	107	TBE186311	107	TBE256310	107	TBEZ4225	106	TBI165532	111
TBE146319	107	TBE166315	107	TBE186312	107	TBE256311	107	TBEZ4232	106	TBI165538	111
TBE146320	107	TBE166316	107	TBE186313	107	TBE256312	107	TBEZ4238	106	TBI165550	111
TBE146322	107	TBE166318	107	TBE186314	107	TBE256313	107	TBEZ4813	106	TBI165558	111
TBE146324	107	TBE166319	107	TBE186315	107	TBE256314	107	TBEZ4816	106	TBI165565	111
TBE146325	107	TBE166320	107	TBE186316	107	TBE256315	107	TBEZ4819	106	TBI165580	111
TBE146332	107	TBE166322	107	TBE186318	107	TBE256316	107	TBEZ4825	106	TBI166325	111
TBE146338	107	TBE166324	107	TBE186319	107	TBE256318	107	TBEZ4832	106	TBI4825	111
TBE146350	107	TBE166325	107	TBE186320	107	TBE256319	107	TBEZ4838	106	TBI5525	111
TBE146363	107	TBE166325BP	106	TBE186322	107	TBE256320	107	TBEZ4850	106	TBI5532	111
TBE146375	107	TBE166332	107	TBE186324	107	TBE256322	107	TBEZ4860	106	TBI5538	111
TBE146380	107	TBE166338	107	TBE186325	107	TBE256324	107	TBEZ4870	106	TBI5550	111
TBE146390	107	TBE166338BP	106	TBE186332	107	TBE256325	107	TBEZ5519	106	TBI5558	111
TBE163509	107	TBE166350	107	TBE186338	107	TBE256332	107	TBEZ5522	106	TBI5565	111
TBE163513	107	TBE166363	107	TBE186350	107	TBE256338	107	TBEZ5525	106	TBI5580	111
TBE163516	107	TBE166375	107	TBE186363	107	TBE256350	107	TBEZ5532	106	TBI6325	111
TBE163519	107	TBE166380	107	TBE186375	107	TBE256363	107	TBEZ5538	106	TBPLN3525	130
TBE164213	107	TBE166390	107	TBE186380	107	TBE256375	107	TBEZ5550	106	TBPLN3535	130
TBE164216	107	TBE183509	107	TBE186390	107	TBE256380	107	TBEZ5563	106	TBPLN3545	130
TBE164219	107	TBE183513	107	TBE253509	107	TBE256390	107	TBEZ5575	106	TBPN3513	118
TBE164225	107	TBE183516	107	TBE253513	107	TBEI4213	109	TBEZ6310	106	TBPN3516	118
TBE164232	107	TBE183519	107	TBE253516	107	TBEI4216	109	TBEZ6311	106	TBPN3519	118
TBE164238	107	TBE184213	107	TBE253519	107	TBEI4219	109	TBEZ6312	106	TBPN3525	118
TBE164813	107	TBE184216	107	TBE254213	107	TBEI4813	109	TBEZ6313	106	TBPN4216	118
TBE164816	107	TBE184219	107	TBE254216	107	TBEI4816	109	TBEZ6314	106	TBPN4219	118
TBE164819	107	TBE184225	107	TBE254219	107	TBEI4819	109	TBEZ6315	106	TBPN4225	118
TBE164819BP	106	TBE184232	107	TBE254225	107	TBEI4825	109	TBEZ6316	106	TBPN4232	118

COD.	PAG.	COD.	PAG.	COD.	PAG.	COD.	PAG.	COD.	PAG.	COD.	PAG.
TBPN4238	118	TBRI3509	117	TBRZ3532	115	TBTN4816	116	TFI63160	113	TINVZ7050	123
TBPN4825	118	TBRI3513	117	TBRZ3913	115	TBTN4819	116	THCH1665032	50	TINVZ7060	123
TBPN4832	118	TBRI3916	117	TBRZ3916	115	TBTN4825	116	THCH1665045	50	TINVZ7070	123
TBPN4838	118	TBRI3919	117	TBRZ3919	115	TBTN4832	116	THCH1665057	50	TINVZ7080	123
TBPN4850	118	TBRI3925	117	TBRZ3925	115	TBTN4838	116	THCH1665070	50	TINVZ7090	123
TBPZ3509	118	TBRI4213	117	TBRZ3932	115	TBTN4845	116	THCH1665080	50	TINVZ7105	123
TBPZ3511	118	TBRI4216	117	TBRZ4213	115	TBTN4850	116	THCH1665100	50	TINVZ7120	123
TBPZ3513	118	TBRI4219	117	TBRZ4216	115	TBTN4860	116	THCH1665115	50	TINVZ7140	123
TBPZ3516	118	TBRI4225	117	TBRZ4219	115	TBTN4870	116	THCH1665125	50	TINVZ7165	123
TBPZ3519	118	TBRI4816	117	TBRZ4222	115	TBTZ3509	116	THCH1665150	50	TINVZ7205	123
TBPZ3522	118	TBRI4819	117	TBRZ4225	115	TBTZ3513	116	THCH1665180	50	TK30	57
TBPZ3525	118	TBRI4825	117	TBRZ4232	115	TBTZ3516	116	THCH1665200	50	TK40	103
TBPZ3913	118	TBRI4832	117	TBRZ4238	115	TBTZ3519	116	THCH1865032	50	TK50	104
TBPZ3916	118	TBRI4838	117	TBRZ4250	115	TBTZ4213	116	THCH1865045	50	TK51	52
TBPZ3919	118	TBRI4850	117	TBRZ4810	115	TBTZ4216	116	THCH65032	50	TK52	52
TBPZ3922	118	TBRN3509	115	TBRZ4811	115	TBTZ4219	116	THCH65045	50	TK53	52
TBPZ3925	118	TBRN3513	115	TBRZ4812	115	TBTZ4225	116	THCH65057	50	TK54	52
TBPZ3932	118	TBRN3516	115	TBRZ4813	115	TBTZ4810	116	THCH65070	50	TK55	52
TBPZ3938	118	TBRN3519	115	TBRZ4816	115	TBTZ4812	116	THCH65080	50	TM06	45
TBPZ4213	118	TBRN4213	115	TBRZ4819	115	TBTZ4816	116	THCH65100	50	TM08	45
TBPZ4216	118	TBRN4216	115	TBRZ4822	115	TBTZ4819	116	THCH65115	50	TM10	45
TBPZ4219	118	TBRN4219	115	TBRZ4825	115	TBTZ4825	116	THCH65125	50	TM10	54
TBPZ4222	118	TBRN4225	115	TBRZ4832	115	TBTZ4832	116	THCH65150	50	TM12	45
TBPZ4225	118	TBRN4232	115	TBRZ4838	115	TBTZ4838	116	THCH65180	50	TMKDF06035	49
TBPZ4232	118	TBRN4238	115	TBRZ4845	115	TBTZ4845	116	THCH65200	50	TMKDF06065	49
TBPZ4238	118	TBRN4816	115	TBRZ4850	115	TBTZ4850	116	TINVI7050	123	TMKE05040	48
TBPZ4813	118	TBRN4819	115	TBRZ4860	115	TBTZ4860	116	TINVI7060	123	TMKE05060	48
TBPZ4816	118	TBRN4825	115	TBRZ4870	115	TBTZ4870	116	TINVI7070	123	TMKE06040	48
TBPZ4819	118	TBRN4832	115	TBRZ4880	115	TBTZ4875	116	TINVI7080	123	TMKE06060	48
TBPZ4822	118	TBRN4838	115	TBRZ4890	115	TBTZ4890	116	TINVN6040	123	TMKE06080	48
TBPZ4825	118	TBRN4845	115	TBRZ5519	115	TCHI14	104	TINVN6050	123	TMKE06100	48
TBPZ4832	118	TBRN4850	115	TBRZ5522	115	TCHI18	104	TINVN6060	123	TMKE08060	48
TBPZ4838	118	TBRP3509	117	TBRZ5525	115	TCHI22	104	TINVN6070	123	TMKE08070	48
TBPZ4845	118	TBRP3513	117	TBRZ5532	115	TCHI27	104	TINVN7030	123	TMKE08090	48
TBPZ4850	118	TBRP3516	117	TBRZ5538	115	TCR42B	116	TINVN7040	123	TMKE08100	48
TBPZ4860	118	TBRP4213	117	TBRZ5545	115	TCR42N	116	TINVN7050	123	TMKE08120	48
TBPZ4870	118	TBRP4216	117	TBRZ5560	115	TCR48B	116	TINVN7060	123	TMKE10060	48
TBPZ4880	118	TBRP4219	117	TBRZ5573	115	TCR48N	116	TINVN7070	123	TMKE10070	48
TBPZ5519	118	TBRP4825	117	TBTN3509	116	TCR55B	116	TINVN7080	123	TMKE10080	48
TBPZ5525	118	TBRZ3509	115	TBTN3513	116	TCR55N	116	TINVN7090	123	TMKE10100	48
TBPZ5532	118	TBRZ3511	115	TBTN3516	116	TFI63110	113	TINVZ6040	123	TMKE10120	48
TBPZ5538	118	TBRZ3513	115	TBTN3519	116	TFI63115	113	TINVZ6050	123	TMKE10150	48
TBPZ5550	118	TBRZ3516	115	TBTN4213	116	TFI63120	113	TINVZ6060	123	TMKE10160	48
TBPZ5560	118	TBRZ3519	115	TBTN4216	116	TFI63125	113	TINVZ6070	123	TMKE12080	48
TBPZ5570	118	TBRZ3522	115	TBTN4219	116	TFI63130	113	TINVZ7030	123	TMKE12110	48
TBPZ5580	118	TBRZ3525	115	TBTN4225	116	TFI63150	113	TINVZ7040	123	TMKE14080	48

COD.	PAG.	COD.	PAG.	COD.	PAG.	COD.	PAG.	COD.	PAG.	COD.	PAG.
TMKE14110	48	TNYLGXLS200	71	TPOB25020	128	TPOB50080	128	TPOR40030	127	TPOZ45025	129
TMKE14130	48	TNYLGXLS240	71	TPOB25025	128	TPOB50090	128	TPOR40035	127	TPOZ45030	129
TMKE14150	48	TOC1212	54	TPOB30012	128	TPOB50100	128	TPOR40040	127	TPOZ45035	129
TMKI06050	48	TOC121450	54	TPOB30016	128	TPOB50120	128	TPOR40050	127	TPOZ45040	129
TMKI06060	48	TOC1216	54	TPOB30020	128	TPOB60040	128	TPOR45016	127	TPOZ45045	129
TMKI08070	48	TOC121650	54	TPOB30025	128	TPOB60050	128	TPOR45020	127	TPOZ45050	129
TMKI08080	48	TOC1219	54	TPOB30030	128	TPOB60060	128	TPOR45025	127	TPOZ45060	129
TMKI10090	48	TOC122050	54	TPOB30040	128	TPOB60070	128	TPOR45030	127	TPOZ45070	129
TMKI10100	48	TOC1223	54	TPOB35010	128	TPOB60080	128	TPOR45035	127	TPOZ45080	129
TMKI10120	48	TOC122550	54	TPOB35012	128	TPOB60090	128	TPOR45040	127	TPOZ50020	129
TMKS06040	49	TOC1230	54	TPOB35016	128	TPOB60100	128	TPOR45045	127	TPOZ50025	129
TMKS06050	49	TOC123050	54	TPOB35020	128	TPOB60110	128	TPOR50020	127	TPOZ50030	129
TMKS06060	49	TOC1235	54	TPOB35025	128	TPOB60120	128	TPOR50030	127	TPOZ50035	129
TMKS06100	49	TOC1240	54	TPOB35030	128	TPOB60130	128	TPOR50040	127	TPOZ50040	129
TMKS06120	49	TOC1245	54	TPOB35035	128	TPOB60140	128	TPOR50050	127	TPOZ50045	129
TMKS06140	49	TOC1250	54	TPOB35040	128	TPOB60150	128	TPOZ25010	129	TPOZ50050	129
TMKTB06040	49	TOC1290	54	TPOB35050	128	TPOB60160	128	TPOZ25012	129	TPOZ50060	129
TMKTL06040	49	TOC5021	54	TPOB40016	128	TPOB60180	128	TPOZ25016	129	TPOZ50070	129
TMKTL06060	49	TOC5027	54	TPOB40020	128	TPOB60200	128	TPOZ25020	129	TPOZ50080	129
TMV06	45	TPCA4213	131	TPOB40025	128	TPOB60220	128	TPOZ25025	129	TPOZ50090	129
TMV08	45	TPCA4216	131	TPOB40030	128	TPOI23016	129	TPOZ30012	129	TPOZ50100	129
TMV10	45	TPCA4219	131	TPOB40035	128	TPOI23025	129	TPOZ30016	129	TPOZ50120	129
TMV1011	45	TPCA4225	131	TPOB40040	128	TPOI23520	129	TPOZ30020	129	TPOZ60040	129
TMV1013	45	TPLCI35025	130	TPOB40045	128	TPOI23525	129	TPOZ30025	129	TPOZ60050	129
TMV1085	45	TPLCI35035	130	TPOB40050	128	TPOI23530	129	TPOZ30030	129	TPOZ60060	129
TMV12	45	TPLN35019	130	TPOB40060	128	TPOI23540	129	TPOZ30040	129	TPOZ60070	129
TMV1210	45	TPLN35025	130	TPOB40070	128	TPOI24030	129	TPOZ35010	129	TPOZ60080	129
TMV1211	45	TPLN35025BP	130	TPOB45020	128	TPOI24040	129	TPOZ35012	129	TPOZ60090	129
TMV1213	45	TPLN35035	130	TPOB45025	128	TPOI24050	129	TPOZ35016	129	TPOZ60100	129
TMV670	45	TPLN35035BP	130	TPOB45030	128	TPOI24530	129	TPOZ35020	129	TPOZ60110	129
TMV685	45	TPLN35045	130	TPOB45035	128	TPOI24540	129	TPOZ35025	129	TPOZ60120	129
TMV875	45	TPLN35055	130	TPOB45040	128	TPOI24550	129	TPOZ35030	129	TPOZ60130	129
TMV890	45	TPLN39025	130	TPOB45045	128	TPOI25040	129	TPOZ35035	129	TPOZ60140	129
TMVD08	45	TPLN39038	130	TPOB45050	128	TPOI25050	129	TPOZ35040	129	TPOZ60150	129
TMVD10	45	TPLN39048	130	TPOB45060	128	TPOI25060	129	TPOZ35050	129	TPOZ60160	129
TN8A14130	55	TPLN39058	130	TPOB45070	128	TPOI25070	129	TPOZ40016	129	TPOZ60180	129
TN8A14160	55	TPLN42065	130	TPOB45080	128	TPOR30016	127	TPOZ40020	129	TPOZ60200	129
TNYLGXL100	71	TPLZ42075	130	TPOB50020	128	TPOR30020	127	TPOZ40025	129	TPOZ60220	129
TNYLGXL108	71	TPLZ48090	130	TPOB50025	128	TPOR35016	127	TPOZ40030	129	TPPM014	131
TNYLGXL120	71	TPLZ48100	130	TPOB50030	128	TPOR35020	127	TPOZ40035	129	TPRA39025	131
TNYLGXL140	71	TPLZ48110	130	TPOB50035	128	TPOR35025	127	TPOZ40040	129	TPRA39035	131
TNYLGXL160	71	TPLZ48120	130	TPOB50040	128	TPOR35030	127	TPOZ40045	129	TPRA39045	131
TNYLGXL810	71	TPLZ48130	130	TPOB50045	128	TPOR35035	127	TPOZ40050	129	TPRA39055	131
TNYLGXL812	71	TPOB25010	128	TPOB50050	128	TPOR40016	127	TPOZ40060	129	TPRA48035	131
TNYLGXL814	71	TPOB25012	128	TPOB50060	128	TPOR40020	127	TPOZ40070	129	TPUPHC01	132
TNYLGXL880	71	TPOB25016	128	TPOB50070	128	TPOR40025	127	TPOZ45020	129	TPUPHC02	132

COD.	PAG.	COD.	PAG.	COD.	PAG.	COD.	PAG.	COD.	PAG.	COD.	PAG.
TPUPHC03	132	TPV50ZM416	119	TR81Z29025	120	TR81Z48100	120	TR82Z35025	121	TR82Z63025	121
TPUPHL01	132	TPV50ZM419	119	TR81Z35006	120	TR81Z48110	120	TR82Z35032	121	TR82Z63032	121
TPUPHL02	132	TPV50ZM425	119	TR81Z35009	120	TR81Z48120	120	TR82Z35038	121	TR82Z63038	121
TPUPHL03	132	TPV50ZM432	119	TR81Z35013	120	TR81Z55013	120	TR82Z39009	121	TR82Z63045	121
TPUPOC01	132	TPV50ZM438	119	TR81Z35016	120	TR81Z55016	120	TR82Z39013	121	TR82Z63050	121
TPUPOC02	132	TR81N29009	120	TR81Z35019	120	TR81Z55019	120	TR82Z39016	121	TR82Z63060	121
TPUPOC03	132	TR81N35009	120	TR81Z35025	120	TR81Z55022	120	TR82Z39019	121	TR82Z63070	121
TPUPOL01	132	TR81N35013	120	TR81Z35032	120	TR81Z55025	120	TR82Z39022	121	TRBI166325	111
TPUPOL02	132	TR81N35016	120	TR81Z39009	120	TR81Z55032	120	TR82Z39025	121	TRBI6325	111
TPUPOL03	132	TR81N35019	120	TR81Z39013	120	TR81Z55038	120	TR82Z39032	121	TRBL4213	110
TPUTOC08	132	TR81N35025	120	TR81Z39016	120	TR81Z55045	120	TR82Z39038	121	TRBL4216	110
TPUTOC10	132	TR81N42016	120	TR81Z39019	120	TR81Z55050	120	TR82Z39045	121	TRBL4219	110
TPUTOC15	132	TR81N42019	120	TR81Z39022	120	TR81Z55060	120	TR82Z39050	121	TRBL4225	110
TPUTOC20	132	TR81N42025	120	TR81Z39025	120	TR81Z55070	120	TR82Z42013	121	TRBL4232	110
TPUTOC25	132	TR81N42032	120	TR81Z39032	120	TR81Z55080	120	TR82Z42016	121	TRBN4213	110
TPUTOC27	132	TR81N42038	120	TR81Z39038	120	TR81Z55090	120	TR82Z42019	121	TRBN4216	110
TPUTOC30	132	TR81N48016	120	TR81Z39045	120	TR81Z55100	120	TR82Z42022	121	TRBN4219	110
TPUTOC40	132	TR81N48019	120	TR81Z39050	120	TR81Z55110	120	TR82Z42025	121	TRBN4225	110
TPV10Z3925	119	TR81N48022	120	TR81Z42009	120	TR81Z55120	120	TR82Z42032	121	TRBN4232	110
TPV10Z3930	119	TR81N48025	120	TR81Z42013	120	TR81Z63016	120	TR82Z42038	121	TRBP4213	110
TPV10Z3938	119	TR81N48032	120	TR81Z42016	120	TR81Z63019	120	TR82Z42045	121	TRBP4216	110
TPV10Z3945	119	TR81N48038	120	TR81Z42019	120	TR81Z63022	120	TR82Z42050	121	TRBP4219	110
TPV20B4316	119	TR81N48045	120	TR81Z42022	120	TR81Z63025	120	TR82Z42060	121	TRBP4225	110
TPV20B4319	119	TR81N48050	120	TR81Z42025	120	TR81Z63032	120	TR82Z42070	121	TRBP4232	110
TPV20B4322	119	TR81N48060	120	TR81Z42032	120	TR81Z63038	120	TR82Z48013	121	TRBZ4213	110
TPV20B4325	119	TR81N48070	120	TR81Z42038	120	TR81Z63045	120	TR82Z48016	121	TRBZ4216	110
TPV20B4330	119	TR81N48080	120	TR81Z42045	120	TR81Z63050	120	TR82Z48019	121	TRBZ4219	110
TPV20B4338	119	TR81N48090	120	TR81Z42050	120	TR81Z63060	120	TR82Z48022	121	TRBZ4225	110
TPV20B4345	119	TR81N48100	120	TR81Z42060	120	TR81Z63070	120	TR82Z48025	121	TRBZ4232	110
TPV20B4355	119	TR81N48110	120	TR81Z42070	120	TR81Z63080	120	TR82Z48032	121	TRE164816	109
TPV20Z4316	119	TR81N48120	120	TR81Z42080	120	TR81Z63090	120	TR82Z48038	121	TRE164819	109
TPV20Z4319	119	TR81P35009	121	TR81Z42090	120	TR81Z63100	120	TR82Z48045	121	TRE165522	109
TPV20Z4322	119	TR81P35013	121	TR81Z48009	120	TR81Z63110	120	TR82Z48050	121	TRE166320	109
TPV20Z4325	119	TR81P35016	121	TR81Z48013	120	TR81Z63120	120	TR82Z48060	121	TRE166325	109
TPV20Z4330	119	TR81P35025	121	TR81Z48016	120	TR82Z29006	121	TR82Z48070	121	TRE166332	109
TPV20Z4338	119	TR81P42013	121	TR81Z48019	120	TR82Z29009	121	TR82Z55013	121	TRE166338	109
TPV20Z4345	119	TR81P42016	121	TR81Z48022	120	TR82Z29013	121	TR82Z55016	121	TRE166350	109
TPV20Z4355	119	TR81P42025	121	TR81Z48025	120	TR82Z29016	121	TR82Z55019	121	TRE166363	109
TPV40Z3913	119	TR81P42032	121	TR81Z48032	120	TR82Z29019	121	TR82Z55022	121	TRE166380	109
TPV40Z3916	119	TR81P48025	121	TR81Z48038	120	TR82Z29022	121	TR82Z55025	121	TRE4816	109
TPV40Z3919	119	TR81Z29006	120	TR81Z48045	120	TR82Z29025	121	TR82Z55032	121	TRE4819	109
TPV40Z3922	119	TR81Z29009	120	TR81Z48050	120	TR82Z35009	121	TR82Z55038	121	TRE5522	109
TPV40Z3925	119	TR81Z29013	120	TR81Z48060	120	TR82Z35013	121	TR82Z55045	121	TRE6320	109
TPV40Z3932	119	TR81Z29016	120	TR81Z48070	120	TR82Z35016	121	TR82Z55050	121	TRE6325	109
TPV40Z3938	119	TR81Z29019	120	TR81Z48080	120	TR82Z35019	121	TR82Z55060	121	TRE6332	109
TPV50ZM413	119	TR81Z29022	120	TR81Z48090	120	TR82Z35022	121	TR82Z55070	121	TRE6338	109

COD.	PAG.	COD.	PAG.	COD.	PAG.	COD.	PAG.	COD.	PAG.	COD.	PAG.
TRE6350	109	TS31655130	112	TS934Z04	134	TTB06	52	TTCGR	132	TTOB50040	128
TRE6363	109	TS31655150	112	TS934Z05	134	TTB08	52	TTCHA	132	TTOB50045	128
TRE6380	109	TS31655180	112	TS934Z06	134	TTB10	52	TTCL0	132	TTOB50050	128
TREAV0411	169	TS31655200	112	TS934Z08	134	TTB12	52	TTCL1	132	TTOB50060	128
TREAV0513	169	TS31655230	112	TS934Z10	134	TTB16	52	TTCL3	132	TTOB50070	128
TREAV0616	169	TS355060	112	TS934Z12	134	TTB20	52	TTCNE	132	TTOB50080	128
TREAV0819	169	TS355082	112	TS934Z14	134	TTBCE06	52	TTCNO	132	TTOB50090	128
TREAV1021	169	TS355098	112	TS934Z16	134	TTBCE08	52	TTCPI	132	TTOB50100	128
TRECA0310	169	TS355115	112	TS934Z18	134	TTBCE10	52	TTCRO	132	TTOB50120	128
TRECA0411	169	TS355130	112	TS934Z20	134	TTBCE12	52	TTCSA	132	TTOB60060	128
TRECA0412	169	TS355150	112	TS934Z22	134	TTBCE16	52	TTO04	53	TTOB60070	128
TRECA0513	169	TS355180	112	TS934Z24	134	TTBI06	52	TTO05	53	TTOB60080	128
TRECA0516	169	TS355200	112	TS934Z27	134	TTBI08	52	TTO06	53	TTOB60090	128
TRECA0616	169	TS355230	112	TS934Z30	134	TTBI10	52	TTO06LE	53	TTOB60100	128
TRECA0617	169	TS51655075	112	TS934Z33	134	TTBI12	52	TTO08	53	TTOB60110	128
TRECA0817	169	TS51655085	112	TS934Z36	134	TTBI16	52	TTO08LE	53	TTOB60120	128
TRECA0820	169	TS51655105	112	TS975Z04	134	TTBI20	52	TTO10	53	TTOB60130	128
TRECA1019	169	TS51655130	112	TS975Z05	134	TTBL06	52	TTO10LE	53	TTOB60140	128
TRECA1024	169	TS51655150	112	TS975Z06	134	TTBL08	52	TTO12	53	TTOB60150	128
TRECA1225	169	TS51655175	112	TS975Z08	134	TTBL11	52	TTO532	53	TTOB60160	128
TRECR0410	169	TS51655180	112	TS975Z10	134	TTBL12	52	TTOB30025	128	TTOB60180	128
TRECR0511	169	TS51655200	112	TS975Z12	134	TTBL16	52	TTOB30030	128	TTOB60200	128
TRECR0614	169	TS51655230	112	TS975Z14	134	TTBLCE06	52	TTOB35016	128	TTOB60220	128
TRECR0815	169	TS51655240	112	TS975Z16	134	TTBLCE08	52	TTOB35020	128	TTS01	38
TRECR1019	169	TS555075	112	TS975Z18	134	TTBLCE10	52	TTOB35025	128	TTS02	38
TRR16	54	TS555085	112	TS975Z20	134	TTBLCE12	52	TTOB35030	128	TTS05	38
TS125Z04	135	TS555105	112	TS975Z22	134	TTBLCE16	52	TTOB35040	128	TTS06	38
TS125Z05	135	TS555130	112	TS975Z24	134	TTBRZ40030	127	TTOB35050	128	TTS08	38
TS125Z06	135	TS555150	112	TS975Z27	134	TTBRZ40035	127	TTOB40020	128	TTS09	38
TS125Z08	135	TS555175	112	TS975Z2M06	134	TTBRZ40040	127	TTOB40025	128	TTS095	38
TS125Z10	135	TS555180	112	TS975Z2M08	134	TTBRZ40045	127	TTOB40030	128	TTS10	38
TS125Z12	135	TS555200	112	TS975Z30	134	TTBRZ40050	127	TTOB40035	128	TTS1017	38
TS125Z14	135	TS555230	112	TS975Z33	134	TTBRZ40060	127	TTOB40040	128	TTS10210	38
TS125Z16	135	TS555240	112	TS975Z36	134	TTBRZ40070	127	TTOB40045	128	TTS10230	38
TS125Z18	135	TS9021Z04	135	TS975Z532	134	TTBRZ50050	127	TTOB40050	128	TTS1065	38
TS125Z20	135	TS9021Z05	135	TS985Z04	134	TTBRZ50060	127	TTOB40060	128	TTS1080	38
TS125Z22	135	TS9021Z06	135	TS985Z05	134	TTBRZ50070	127	TTOB40070	128	TTS12	38
TS125Z24	135	TS9021Z08	135	TS985Z06	134	TTBRZ50080	127	TTOB45030	128	TTS120	38
TS125Z27	135	TS9021Z10	135	TS985Z08	134	TTBRZ50090	127	TTOB45035	128	TTS121	38
TS125Z30	135	TS9021Z12	135	TS985Z10	134	TTBRZ50100	127	TTOB45040	128	TTS12100	38
TS125Z33	135	TS9021Z14	135	TS985Z12	134	TTCANT	132	TTOB45045	128	TTS12180	38
TS125Z36	135	TS9021Z16	135	TS985Z14	134	TTCBE	132	TTOB45050	128	TTS122	38
TS31655060	112	TS9021Z18	135	TS985Z16	134	TTCBL	132	TTOB45060	128	TTS12220	38
TS31655082	112	TS9021Z20	135	TS985Z18	134	TTCCE	132	TTOB45070	128	TTS12250	38
TS31655098	112	TS9021Z22	135	TS985Z20	134	TTCGM	132	TTOB50030	128	TTS1270	38
TS31655115	112	TS9021Z24	135	TS985Z24	134	TTCGMR	132	TTOB50035	128	TTS1275	38

COD.	PAG.	COD.	PAG.	COD.	PAG.	COD.	PAG.	COD.	PAG.	COD.	PAG.
TTS1280	38	TTSC03	41	TTSKS06	41	TTXCA60280	127	TTXEB35020	125	TTXEB60110	125
TTS1290	38	TTSC04	41	TTSKS07	41	TTXCA60300	127	TTXEB35025	125	TTXEB60120	125
TTS14	38	TTSC05	41	TTSKS10	41	TTXCA80050	127	TTXEB35030	125	TTXEB60130	125
TTS14120	38	TTSC06	41	TTSKS12	41	TTXCA80060	127	TTXEB35035	125	TTXEB60140	125
TTS14145	38	TTSC07	41	TTSKS13	41	TTXCA80070	127	TTXEB35040	125	TTXEB60150	125
TTS14170	38	TTSC08	41	TTSKS14	41	TTXCA80080	127	TTXEB35045	125	TTXEB60160	125
TTS1620	38	TTSC09	41	TTSKS15	41	TTXCA80100	127	TTXEB35050	125	TTXEB60180	125
TTS1690	38	TTSC11	41	TTSKS17	41	TTXCA80120	127	TTXEB35060	125	TTXEB60200	125
TTS17	38	TTSC12	41	TTSKS20	41	TTXCA80140	127	TTXEB40016	125	TTXEB60220	125
TTS18	38	TTSC13	41	TTSKS21	41	TTXCA80160	127	TTXEB40020	125	TTXEB60240	125
TTS19	38	TTSC14	41	TTXARB06	126	TTXCA80180	127	TTXEB40025	125	TTXEB60260	125
TTS20	38	TTSC15	41	TTXARB08	126	TTXCA80200	127	TTXEB40030	125	TTXEB60280	125
TTS20120	38	TTSC16	41	TTXARB10	126	TTXCA80220	127	TTXEB40035	125	TTXEB60300	125
TTS2022	38	TTSI05	39	TTXARZ06	126	TTXCA80240	127	TTXEB40040	125	TTXEB80050	125
TTS24	38	TTSI06	39	TTXARZ08	126	TTXCA80260	127	TTXEB40045	125	TTXEB80060	125
TTS24180	38	TTSI09	39	TTXARZ10	126	TTXCA80280	127	TTXEB40050	125	TTXEB80070	125
TTS24260	38	TTSI10120	39	TTXCA10080	127	TTXCA80300	127	TTXEB40060	125	TTXEB80080	125
TTS25	38	TTSI10150	39	TTXCA10100	127	TTXCA80320	127	TTXEB40070	125	TTXEB80090	125
TTS26	38	TTSI1070	39	TTXCA10120	127	TTXCA80360	127	TTXEB45030	125	TTXEB80100	125
TTS27	38	TTSI1090	39	TTXCA10140	127	TTXCA80400	127	TTXEB45035	125	TTXEB80120	125
TTS28	38	TTSI11	39	TTXCA10160	127	TTXEB10080	125	TTXEB45040	125	TTXEB80140	125
TTS29	38	TTSI12	39	TTXCA10180	127	TTXEB10100	125	TTXEB45045	125	TTXEB80150	125
TTS30	38	TTSI120	39	TTXCA10200	127	TTXEB10120	125	TTXEB45050	125	TTXEB80160	125
TTS31	38	TTSI1275	39	TTXCA10220	127	TTXEB10140	125	TTXEB45060	125	TTXEB80180	125
TTS6100	38	TTSI1290	39	TTXCA10240	127	TTXEB10160	125	TTXEB45070	125	TTXEB80200	125
TTS6120	38	TTSI16170	39	TTXCA10260	127	TTXEB10180	125	TTXEB45080	125	TTXEB80220	125
TTS6140	38	TTSI1690	39	TTXCA10280	127	TTXEB10200	125	TTXEB50030	125	TTXEB80240	125
TTS6160	38	TTSI19	39	TTXCA10300	127	TTXEB10220	125	TTXEB50035	125	TTXEB80250	125
TTS660	61	TTSI20	39	TTXCA10320	127	TTXEB10240	125	TTXEB50040	125	TTXEB80260	125
TTS661	38	TTSI20120	39	TTXCA10360	127	TTXEB10250	125	TTXEB50045	125	TTXEB80280	125
TTS670	38	TTSI20170	39	TTXCA10400	127	TTXEB10260	125	TTXEB50050	125	TTXEB80300	125
TTS680	38	TTSI20220	39	TTXCA60030	127	TTXEB10280	125	TTXEB50060	125	TTXEB80320	125
TTS8120	38	TTSI27	39	TTXCA60040	127	TTXEB10300	125	TTXEB50070	125	TTXEB80340	125
TTS8130	38	TTSI6120	39	TTXCA60050	127	TTXEB10320	125	TTXEB50080	125	TTXEB80350	125
TTS8155	38	TTSI6140	39	TTXCA60060	127	TTXEB10340	125	TTXEB50090	125	TTXEB80360	125
TTS860	38	TTSI6160	39	TTXCA60070	127	TTXEB10350	125	TTXEB50100	125	TTXEB80380	125
TTS890	38	TTSI6170	39	TTXCA60080	127	TTXEB10360	125	TTXEB50110	125	TTXEB80400	125
TTS93	38	TTSI6180	39	TTXCA60100	127	TTXEB10380	125	TTXEB50120	125	TTXEI50050	126
TTS94	38	TTSI645	39	TTXCA60120	127	TTXEB10400	125	TTXEB60040	125	TTXEI50060	126
TTS95	38	TTSI660	39	TTXCA60140	127	TTXEB30016	125	TTXEB60045	125	TTXEI50070	126
TTS96	38	TTSI680	39	TTXCA60160	127	TTXEB30020	125	TTXEB60050	125	TTXEZ30016	126
TTS97	38	TTSI8115	39	TTXCA60180	127	TTXEB30025	125	TTXEB60060	125	TTXEZ30020	126
TTS98	38	TTSI850	39	TTXCA60200	127	TTXEB30030	125	TTXEB60070	125	TTXEZ30025	126
TTS99	38	TTSI890	39	TTXCA60220	127	TTXEB30035	125	TTXEB60080	125	TTXEZ30030	126
TTSC01	41	TTSI98	39	TTXCA60240	127	TTXEB30040	125	TTXEB60090	125	TTXEZ30035	126
TTSC02	41	TTSKS05	41	TTXCA60260	127	TTXEB35016	125	TTXEB60100	125	TTXEZ30040	126

COD.	PAG.	COD.	PAG.	COD.	PAG.	COD.	PAG.	COD.	PAG.	COD.	PAG.
TTXEZ35016	126	TTXEZ60100	126	TVGS28	51	VAMA210070	194	VBRB25080	205	VHA17040	204
TTXEZ35020	126	TTXEZ60110	126	TVGS29	51	VAMA210090	194	VBRB25100	205	VHA18040	204
TTXEZ35025	126	TTXEZ60120	126	TVGS30	51	VAMA210120	194	VBRB25140	205	VHA18050	204
TTXEZ35030	126	TTXEZ60130	126	TVGS31	51	VAMA212110	194	VBRB25160	205	VHA19050	204
TTXEZ35035	126	TTXEZ60140	126	TVGS32	51	VAMN06045	194	VBRB25200	205	VHA19060	204
TTXEZ35040	126	TTXEZ60150	126	TVI16532	110	VAMN06060	194	VBRB36140	205	VHA19070	204
TTXEZ35045	126	TTXEZ60160	126	TVI16538	110	VAMN06080	194	VBRB36200	205	VHA20050	204
TTXEZ35050	126	TTXEZ60180	126	TVI16550	110	VAMN08050	194	VBRB36300	205	VHA20060	204
TTXEZ35060	126	TTXEZ60200	126	TVI16560	110	VAMN08075	194	VBRB36370	205	VHA20070	204
TTXEZ40016	126	TTXEZ60220	126	TVI532	110	VAMN08090	194	VBRB48120	205	VHA20080	204
TTXEZ40020	126	TTXEZ60240	126	TVI538	110	VAMN08115	194	VBRB48160	205	VHA21070	204
TTXEZ40025	126	TTXEZ60260	126	TVI550	110	VAMN10070	194	VBRB48180	205	VHA21080	204
TTXEZ40030	126	TTXEZ60280	126	TVI560	110	VAMN10080	194	VBRB48200	205	VHA21090	204
TTXEZ40035	126	TTXEZ60300	126	TVIB165510	111	VAMN10090	194	VBRB48250	205	VHA21100	204
TTXEZ40040	126	TVGC01	51	TVIB165540	111	VAMN10120	194	VBRB48290	205	VHA22110	204
TTXEZ40045	126	TVGC07	51	TVIB165550	111	VAMN12090	194	VBRB48370	205	VHA22120	204
TTXEZ40050	126	TVGC08	51	TVIB165565	111	VAMN12100	194	VBRB76200	205	VHA23130	204
TTXEZ40060	126	TVGC10	51	TVIB165580	111	VAMN12110	194	VBRB76290	205	VHC14025	204
TTXEZ40070	126	TVGC11	51	TVIB5510	111	VAMN12120	194	VBRB76370	205	VHC16030	204
TTXEZ45030	126	TVGC12	51	TVIB5540	111	VAR14025	204	VBRN12225	205	VHC17040	204
TTXEZ45035	126	TVGC13	51	TVIB5550	111	VAR16030	204	VBRN25080	205	VHC18040	204
TTXEZ45040	126	TVGC14	51	TVIB5565	111	VAR17040	204	VBRN25100	205	VHC18050	204
TTXEZ45045	126	TVGC15	51	TVIB5580	111	VAR18040	204	VBRN25140	205	VHC19050	204
TTXEZ45050	126	TVGC16	51	V90002	195	VAR18050	204	VBRN25160	205	VHC19060	204
TTXEZ45060	126	TVGC17	51	VACAR08C	194	VAR19050	204	VBRN25200	205	VHC19070	204
TTXEZ45070	126	TVGC18	51	VACAR10C	194	VAR19060	204	VBRN36140	205	VHC20050	204
TTXEZ45080	126	TVGC19	51	VACGA08C	194	VAR19070	204	VBRN36200	205	VHC20060	204
TTXEZ50030	126	TVGC20	51	VACGA10C	194	VAR20060	204	VBRN36300	205	VHC20070	204
TTXEZ50035	126	TVGC21	51	VACTO08C	194	VAR20070	204	VBRN36370	205	VHC20080	204
TTXEZ50040	126	TVGC22	51	VACTO08L	194	VAR20080	204	VBRN48120	205	VHC21070	204
TTXEZ50045	126	TVGC23	51	VACTO10C	194	VAR21080	204	VBRN48160	205	VHC21080	204
TTXEZ50050	126	TVGCDE10	51	VACTO10L	194	VAR21090	204	VBRN48180	205	VHC21090	204
TTXEZ50060	126	TVGCDE11	51	VACTO12C	194	VAR22100	204	VBRN48200	205	VHC21100	204
TTXEZ50070	126	TVGCDE12	51	VACTO12L	194	VAR22110	204	VBRN48250	205	VHC22110	204
TTXEZ50080	126	TVGCDE13	51	VACTO16C	194	VAR22120	204	VBRN48290	205	VHC22120	204
TTXEZ50090	126	TVGCDE14	51	VACTO208C	194	VAR23130	204	VBRN48370	205	VHC23130	204
TTXEZ50100	126	TVGCDE15	51	VACTO208L	194	VBCAM04	203	VBRN76200	205	VHRN01	195
TTXEZ50110	126	TVGS17	51	VACTO210C	194	VBCAM05	203	VBRN76290	205	VHWACO435	195
TTXEZ50120	126	TVGS18	51	VACTO210L	194	VBCAM06	203	VBRN76370	205	VHWACO440	195
TTXEZ60040	126	TVGS20	51	VACTO212C	194	VBESM04	203	VBRV25100	205	VHWACO446	195
TTXEZ60045	126	TVGS21	51	VACTO212L	194	VBESM05	203	VBRV36140	205	VHWACO537	195
TTXEZ60050	126	TVGS22	51	VAHNM06	195	VBESM06	203	VBRV36200	205	VHWACO550	195
TTXEZ60060	126	TVGS23	51	VAHNM08	195	VBGAM04	203	VBRV48200	205	VHWACO563	195
TTXEZ60070	126	TVGS24	51	VAMA206060	194	VBGAM05	203	VBRV48290	205	VHWACO637	195
TTXEZ60080	126	TVGS25	51	VAMA208075	194	VBGAM06	203	VHA14025	204	VHWACO650	195
TTXEZ60090	126	TVGS27	51	VAMA208090	194	VBRB12225	205	VHA16030	204	VMRHZ0630	195

COD.	PAG.	COD.	PAG.	COD.	PAG.	COD.	PAG.	COD.	PAG.	COD.	PAG.	COD.	PAG.
VMRHZ0825	195	VREMNO4822	202	VTBAZ08050	199	VTBEZ6350	197	VTBRZ4822	197	VTLATM06	195		
VMRHZ1030	195	VREMNO4825	202	VTBAZ08060	199	VTBEZ6363	197	VTBRZ4825	197	VTLATM08	195		
VMRRZ0420	195	VREMNO4830	202	VTBAZ08070	199	VTBPZ3513	198	VTBRZ4832	197	VTLATM10	195		
VMRRZ0630	195	VREMNO4835	202	VTBAZ08080	199	VTBPZ3516	198	VTBRZ4838	197	VTPLN35025	201		
VMRRZ0830	195	VSRTRG095	152	VTBAZ08090	199	VTBPZ3519	198	VTBRZ4845	197	VTPLN35035	201		
VMRRZ1030	195	VT93025	196	VTBAZ08100	199	VTBPZ3525	198	VTBRZ4850	197	VTPLN35045	201		
VPACA04	203	VT93026	196	VTBAZ10060	199	VTBPZ3913	198	VTBRZ4860	197	VTPOB30016	201		
VPACA05	203	VT93027	196	VTBAZ10070	199	VTBPZ3916	198	VTBRZ4880	197	VTPOB30020	201		
VPACA06	203	VT93028	196	VTBAZ10080	199	VTBPZ3919	198	VTBRZ5532	197	VTPOB30025	201		
VPAES04	203	VT93029	196	VTBAZ10090	199	VTBPZ3925	198	VTCR42B	199	VTPOB30030	201		
VPAES05	203	VT93030	196	VTBAZ10100	199	VTBPZ3938	198	VTCR42N	199	VTPOB30040	201		
VPAES06	203	VT93031	196	VTBE144819	197	VTBPZ4213	198	VTCR48B	199	VTPOB35016	201		
VPAGA04	203	VT93032	196	VTBE144825	197	VTBPZ4216	198	VTCR48N	199	VTPOB35020	201		
VPAGA05	203	VT93033	196	VTBE164819	197	VTBPZ4219	198	VTCR55B	199	VTPOB35025	201		
VPAGA06	203	VT93034	196	VTBE165522	197	VTBPZ4225	198	VTCR55N	199	VTPOB35030	201		
VREMCA4010	202	VT93035	196	VTBE165525	197	VTBPZ4232	198	VTGX0525	195	VTPOB35035	201		
VREMCA4012	202	VTABRIBL06	205	VTBE165532	197	VTBPZ4238	198	VTGX0630	195	VTPOB35040	201		
VREMCA4016	202	VTABRIBL08	205	VTBE165538	197	VTBPZ4816	198	VTGX0840	195	VTPOB35050	201		
VREMCA4810	202	VTABRINE06	205	VTBE165550	197	VTBPZ4819	198	VTGX0850	195	VTPOB40016	201		
VREMCA4812	202	VTABRINE08	205	VTBE166325	197	VTBPZ4825	198	VTGX1050	195	VTPOB40020	201		
VREMCA4814	202	VTANUDO06	196	VTBE166332	197	VTBPZ4832	198	VTGX1260	195	VTPOB40025	201		
VREMCA4816	202	VTANUDO08	196	VTBE166338	197	VTBPZ4838	198	VTGX1470	195	VTPOB40030	201		
VREMCA4818	202	VTANUDO10	196	VTBEZ3509	197	VTBPZ4850	198	VTGX57108	196	VTPOB40035	201		
VREMFL4835	202	VTARNEZ14	197	VTBEZ3513	197	VTBPZ5532	198	VTGX57110	196	VTPOB40040	201		
VREMNO3206	202	VTARNEZ16	197	VTBEZ4213	197	VTBRZ3509	197	VTGX57112	196	VTPOB40045	201		
VREMNO3208	202	VTARNEZ18	197	VTBEZ4216	197	VTBRZ3511	197	VTGXA08080	196	VTPOB40050	201		
VREMNO3210	202	VTARNEZ25	197	VTBEZ4219	197	VTBRZ3513	197	VTGXA08100	196	VTPOB40060	201		
VREMNO3212	202	VTAU63019	198	VTBEZ4225	197	VTBRZ3516	197	VTGXA10080	196	VTPOB45030	201		
VREMNO3214	202	VTAU63025	198	VTBEZ4232	197	VTBRZ3519	197	VTGXA10100	196	VTPOB45035	201		
VREMNO3216	202	VTAU63032	198	VTBEZ4813	197	VTBRZ3525	197	VTGXH08080	196	VTPOB45040	201		
VREMNO3218	202	VTAU63040	198	VTBEZ4816	197	VTBRZ3913	197	VTGXH08100	196	VTPOB45045	201		
VREMNO4006	202	VTAU63050	198	VTBEZ4819	197	VTBRZ3916	197	VTGXH10080	196	VTPOB45050	201		
VREMNO4008	202	VTAU63060	198	VTBEZ4825	197	VTBRZ3919	197	VTGXH10100	196	VTPOB45060	201		
VREMNO4010	202	VTAU63080	198	VTBEZ4832	197	VTBRZ3925	197	VTGXTPO05	196	VTPOB45070	201		
VREMNO4012	202	VTBAZ05040	199	VTBEZ4838	197	VTBRZ3932	197	VTGXTPO06	196	VTPOB50030	201		
VREMNO4014	202	VTBAZ05050	199	VTBEZ5519	197	VTBRZ4213	197	VTGXTPO08	196	VTPOB50035	201		
VREMNO4016	202	VTBAZ06040	199	VTBEZ5522	197	VTBRZ4216	197	VTHHTSI21	196	VTPOB50040	201		
VREMNO4018	202	VTBAZ06050	199	VTBEZ5525	197	VTBRZ4219	197	VTHHTSI23	196	VTPOB50050	201		
VREMNO4020	202	VTBAZ06060	199	VTBEZ5532	197	VTBRZ4222	197	VTHHTSI24	196	VTPOB50060	201		
VREMNO4808	202	VTBAZ06070	199	VTBEZ5538	197	VTBRZ4225	197	VTHHTSI25	196	VTPOB50070	201		
VREMNO4810	202	VTBAZ06080	199	VTBEZ5550	197	VTBRZ4232	197	VTINVN7060	199	VTPOB50080	201		
VREMNO4812	202	VTBAZ07050	199	VTBEZ5563	197	VTBRZ4238	197	VTINVN7070	199	VTPOB50090	201		
VREMNO4814	202	VTBAZ07060	199	VTBEZ6319	197	VTBRZ4250	197	VTINVN7080	199	VTPOB50100	201		
VREMNO4816	202	VTBAZ07070	199	VTBEZ6325	197	VTBRZ4813	197	VTINVZ7060	199	VTPOB60040	201		
VREMNO4818	202	VTBAZ07080	199	VTBEZ6332	197	VTBRZ4816	197	VTINVZ7070	199	VTPOB60050	201		
VREMNO4820	202	VTBAZ08040	199	VTBEZ6338	197	VTBRZ4819	197	VTINVZ7080	199	VTPOB60060	201		

COD.	PAG.	COD.	PAG.	COD.	PAG.	COD.	PAG.	COD.	PAG.	COD.	PAG.
VTPOB60070	201	VTPOZ60090	201	VTR82Z35009	199	VTT0B45050	202	VTTXEB50050	200	VTTXEZ60050	200
VTPOB60080	201	VTPOZ60100	201	VTR82Z35013	199	VTT0B45060	202	VTTXEB50060	200	VTTXEZ60060	200
VTPOB60090	201	VTR81Z29006	198	VTR82Z35016	199	VTT0B45070	202	VTTXEB50070	200	VTTXEZ60070	200
VTPOB60100	201	VTR81Z29009	198	VTR82Z35019	199	VTT0B50030	202	VTTXEB50080	200	VTTXEZ60080	200
VTPOZ30016	201	VTR81Z35006	198	VTR82Z35022	199	VTT0B50035	202	VTTXEB50090	200	WED5222-BC	159
VTPOZ30020	201	VTR81Z35009	198	VTR82Z35025	199	VTT0B50040	202	VTTXEB60050	200		
VTPOZ30025	201	VTR81Z35013	198	VTR82Z35032	199	VTT0B50050	202	VTTXEB60060	200		
VTPOZ30030	201	VTR81Z35016	198	VTR82Z39016	199	VTT0B50060	202	VTTXEB60070	200		
VTPOZ30040	201	VTR81Z35019	198	VTR82Z39019	199	VTT0B50070	202	VTTXEB60080	200		
VTPOZ35016	201	VTR81Z35025	198	VTR82Z39022	199	VTT0B50080	202	VTTXEI50050	200		
VTPOZ35020	201	VTR81Z39009	198	VTR82Z39025	199	VTT0B50090	202	VTTXEI50060	200		
VTPOZ35025	201	VTR81Z39013	198	VTR82Z39032	199	VTT0B50100	202	VTTXEI50070	200		
VTPOZ35030	201	VTR81Z39016	198	VTR82Z42013	199	VTT0B60060	202	VTTXEZ30016	200		
VTPOZ35035	201	VTR81Z39019	198	VTR82Z42016	199	VTT0B60070	202	VTTXEZ30020	200		
VTPOZ35040	201	VTR81Z39022	198	VTR82Z42019	199	VTT0B60080	202	VTTXEZ30025	200		
VTPOZ35050	201	VTR81Z39025	198	VTR82Z42025	199	VTT0B60090	202	VTTXEZ30030	200		
VTPOZ40016	201	VTR81Z42009	198	VTR82Z42032	199	VTT0B60100	202	VTTXEZ30040	200		
VTPOZ40020	201	VTR81Z42013	198	VTR82Z42038	199	VTTXEB30016	200	VTTXEZ35016	200		
VTPOZ40025	201	VTR81Z42016	198	VTR82Z48019	199	VTTXEB30020	200	VTTXEZ35020	200		
VTPOZ40030	201	VTR81Z42019	198	VTR82Z48025	199	VTTXEB30025	200	VTTXEZ35025	200		
VTPOZ40035	201	VTR81Z42022	198	VTR82Z48032	199	VTTXEB30030	200	VTTXEZ35030	200		
VTPOZ40040	201	VTR81Z42025	198	VTR82Z48038	199	VTTXEB30040	200	VTTXEZ35035	200		
VTPOZ40045	201	VTR81Z42032	198	VTR82Z55019	199	VTTXEB35016	200	VTTXEZ35040	200		
VTPOZ40050	201	VTR81Z42038	198	VTR82Z55025	199	VTTXEB35020	200	VTTXEZ35050	200		
VTPOZ40060	201	VTR81Z42050	198	VTR82Z55032	199	VTTXEB35025	200	VTTXEZ40025	200		
VTPOZ45030	201	VTR81Z48009	198	VTR82Z55038	199	VTTXEB35030	200	VTTXEZ40030	200		
VTPOZ45035	201	VTR81Z48013	198	VTT0B30025	202	VTTXEB35035	200	VTTXEZ40035	200		
VTPOZ45040	201	VTR81Z48016	198	VTT0B30030	202	VTTXEB35040	200	VTTXEZ40040	200		
VTPOZ45045	201	VTR81Z48019	198	VTT0B35016	202	VTTXEB35050	200	VTTXEZ40045	200		
VTPOZ45050	201	VTR81Z48025	198	VTT0B35020	202	VTTXEB40025	200	VTTXEZ40050	200		
VTPOZ45060	201	VTR81Z48032	198	VTT0B35025	202	VTTXEB40030	200	VTTXEZ40060	200		
VTPOZ45070	201	VTR81Z48038	198	VTT0B35030	202	VTTXEB40035	200	VTTXEZ45030	200		
VTPOZ50030	201	VTR81Z48045	198	VTT0B35040	202	VTTXEB40040	200	VTTXEZ45035	200		
VTPOZ50035	201	VTR81Z48050	198	VTT0B35050	202	VTTXEB40045	200	VTTXEZ45040	200		
VTPOZ50040	201	VTR81Z48060	198	VTT0B40020	202	VTTXEB40050	200	VTTXEZ45045	200		
VTPOZ50050	201	VTR81Z48070	198	VTT0B40025	202	VTTXEB40060	200	VTTXEZ45050	200		
VTPOZ50060	201	VTR81Z48080	198	VTT0B40030	202	VTTXEB45030	200	VTTXEZ45060	200		
VTPOZ50070	201	VTR81Z55019	198	VTT0B40035	202	VTTXEB45035	200	VTTXEZ45070	200		
VTPOZ50080	201	VTR81Z55025	198	VTT0B40040	202	VTTXEB45040	200	VTTXEZ50030	200		
VTPOZ50090	201	VTR81Z55032	198	VTT0B40045	202	VTTXEB45045	200	VTTXEZ50035	200		
VTPOZ50100	201	VTR81Z55038	198	VTT0B40050	202	VTTXEB45050	200	VTTXEZ50040	200		
VTPOZ60040	201	VTR81Z55050	198	VTT0B40060	202	VTTXEB45060	200	VTTXEZ50050	200		
VTPOZ60050	201	VTR82Z29006	199	VTT0B45030	202	VTTXEB45070	200	VTTXEZ50060	200		
VTPOZ60060	201	VTR82Z29009	199	VTT0B45035	202	VTTXEB50030	200	VTTXEZ50070	200		
VTPOZ60070	201	VTR82Z29013	199	VTT0B45040	202	VTTXEB50035	200	VTTXEZ50080	200		
VTPOZ60080	201	VTR82Z29016	199	VTT0B45045	202	VTTXEB50040	200	VTTXEZ50090	200		

*La gran fortaleza de nuestro Grupo
reside en la flexibilidad de una empresa internacional
a nivel humano*



G&B Group

**G&B Fissaggi
Italia**

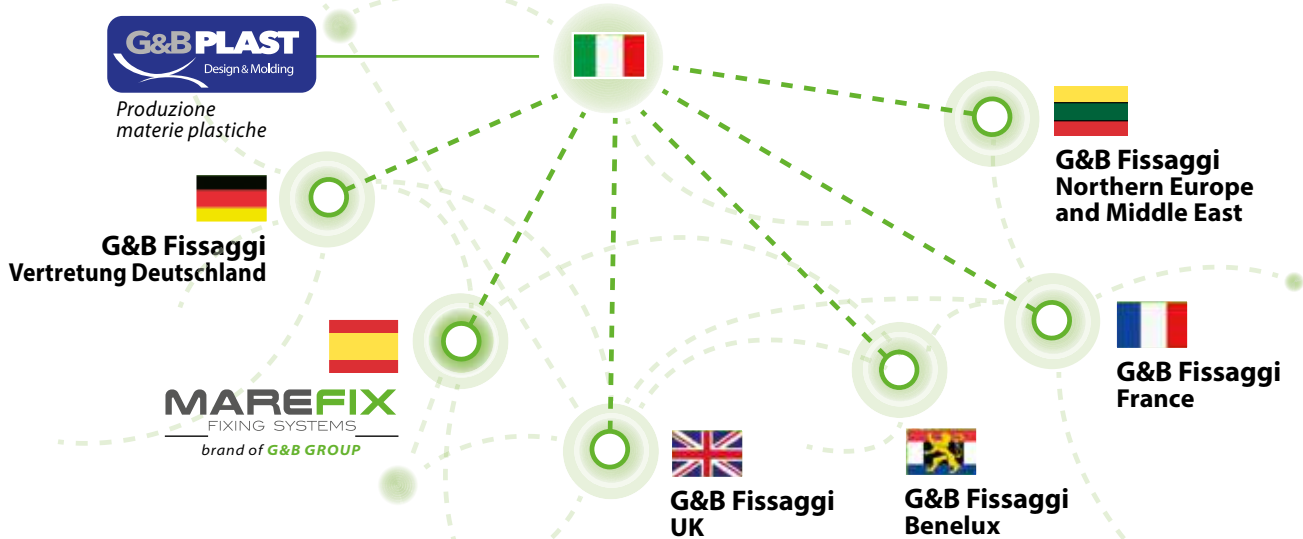

G&B PLAST
Design & Molding
Produzione materie plastiche

**G&B Fissaggi
Vertretung Deutschland**

MAREFIX
FIXING SYSTEMS
brand of G&B GROUP

**G&B Fissaggi
Northern Europe
and Middle East**

**G&B Fissaggi
France**

**G&B Fissaggi
UK**

**G&B Fissaggi
Benelux**

MAREFIX[®]
FIXING SYSTEMS
by **G&B GROUP**

MAREFIX S.L.U.
Pol. Industrial La Variante, Calle La Grajera, 7
26140 Lardero, La Rioja, Spain

+34 941.447.825

marefix@marefix.com



MAREFIX Spain
marefix@marefix.com

G&B Fissaggi UK
uksales@gebfixaggi.com

G&B Fissaggi Vertretung Deutschland
johnengebfixaggi@gmail.com

G&B Fissaggi Benelux
export@gebfixaggi.com

G&B Fissaggi France
export@gebfixaggi.com

**G&B Fissaggi
Northern Europe
and Middle East**
tomas.t@gebfixaggi.com

